

Just for your
Tandy Color
Computer 1, 2 and 3

May 1988

Canada \$4.95 U.S. \$3.95

The RAINBOW

THE COLOR COMPUTER MONTHLY MAGAZINE

Putting it on Paper

- Color Graphics Printing on the CGP-220
- Formatting for LLIST and Two-Column Text
- A Self-Centering Poster Printer
- Alternate Fonts for PMODE4

Plus:

- Wall-bashing on the Colorful Courts of Strata,
- A RAM Pack for Your ROM Port,
- The Ins and Outs of Boolean,
- A Strategy Game You'll Flip Over, and MORE!





DIECOM PRODUCTS INC.

THE RAT GRAPHIC DESIGN PACKAGE

This is the most complete graphics design package currently available for the Coco 3. It supports 320 x 200 hi-res graphics with a 16 color user definable palette. You can draw lines, circles, ovals, boxes, polygons and many more standard drawing functions. You can get stamps from the screen which can then be enlarged, shrunk, rotated, inverted and flipped and then be redisplayed on the screen in various ways. You can paint areas of the pre-defined fonts or the pre-defined color textures. You can label your pictures with one of the pre-defined fonts or define your own custom lettering style. Now don't worry about trying to draw your pictures with the keyboard or even a cumbersome joystick. "THE RAT" comes with its own MOUSE. Yes that's right, it comes with a MOUSE and not a simple analog one button mouse like the Tandy 1000. You don't have to worry about selection squares around your drawing screen, just push a button on the mouse and you flip to a separate screen to select your drawing mode. Or you can use one of our pull down menus to load and save your pictures on disk. We also include screen print routines for many of the most popular printers.



Now that's a GRAPHIC DESIGN PACKAGE that beats them all! That's right, you get the graphics program, screen print routines, the mouse and the mouse pad all for one low price of

\$69.95 U.S.
\$99.95 Can.

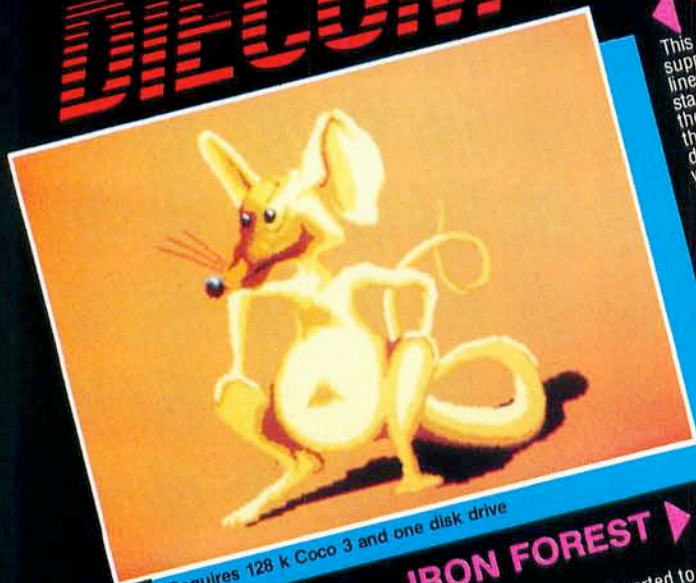

Requires 128 k Coco 3 and one disk drive

IRON FOREST

This is the first in our series of light phaser games. You have just been teleported to a strange land. As the mist clears you find a light phaser in your hand and yourself deep inside the Iron Forest. Your mission: to protect the sacred White Dove and all good creatures from the evil of the forest. As you aim, you zap a space pod, and then quickly turn and zap an evil spinning blade as it comes dangerously close to the Dove. Many evil creatures inhabit the forest. How long can you keep them under control? Many different backgrounds and increasing difficulty make this a unique new game for your Coco 3.

Iron Forest
\$28.95 U.S.
\$38.95 Can.



Game and phaser together
\$59.95 U.S.
\$83.95 Can.



Requires 128 k Coco 3 and one disk drive

\$28.95 U.S. NEW LOW
\$38.95 CAN. PRICE DISK ONLY

GATES OF DELIRIUM

Once you have purchased one light phaser you will only need to purchase future games at regular price.

\$28.95 U.S.
\$38.95 CAN.

WRESTLE MANIAC



\$28.95 U.S.
\$38.95 CAN.

GANTELET

\$28.95 U.S.
\$38.95 CAN.

BOUNCING BOULDERS

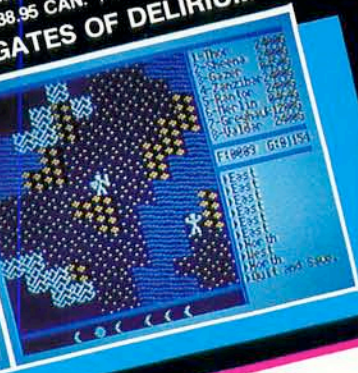

For the Coco 1, 2 or 3

DIECOM PRODUCTS INC.

6715 FIFTH LINE, MILTON, ONT., CANADA L9T 2X8

We accept:



cheque or money order

24 hr. order line:
(416) 878-8358
personal service 9-5

Please add \$2 shipping & handling (for 'The Rat' and 'Iron Forest' add \$5 each for shipping). Ontario residents add 7% sales tax. C.O.D. Canada only.

SEE BACK COVER FOR OTHER DIECOM GAMES

From Computer Plus to YOU ...

PLUS after PLUS after PLUS

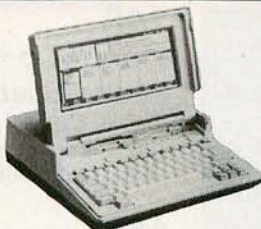

Tandy 1400 LT \$1239
Tandy 102 24K \$379
Tandy 200 24K \$429



Color Computer 3
w/128K Ext. Basic \$159



Tandy 1000 HX \$539
Tandy 1000 TX \$889

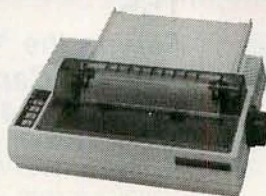

DMP-130A \$279

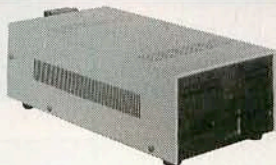

Color Computer Disk Drive
Drive 0 \$249 Drive 1 \$149

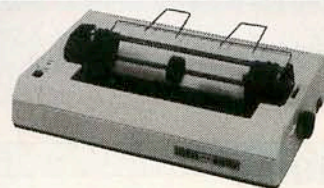

DMP-106 \$169

BIG SAVINGS ON A FULL COMPLEMENT OF RADIO SHACK COMPUTER PRODUCTS

COMPUTERS

Tandy 1000 HX 1 Drive 256K	539.00
Tandy 1000 TX 1 Drive 640K	889.00
Tandy 1000 SX 1 Drive 384K	499.00*
Tandy 3000 HL 1 Drive 512K	899.00
Tandy 4000 1 Drive 1 Meg. Ram	1959.00

PRINTERS

Radio Shack DMP-106 80 CPS	169.00
Radio Shack DMP-130A 120 CPS	279.00
Radio Shack DMP-440 300 CPS	539.00
Radio Shack DWP-230 Daisy Wheel	349.00
Tandy LP-1000 Laser Printer	1699.00
Star Micronics NX-1000 144 CPS	229.00
Star Micronics NX-15 120 CPS	359.00
Panasonic P-1080i 144 CPS	199.00
Panasonic P-1091i 194 CPS	229.00
Panasonic P-1092i 240 CPS	349.00
Okidata 182 + 144 CPS	259.00
Okidata 192 + 200 CPS	359.00
Okidata 292 240 CPS	479.00

MODEMS

Radio Shack DCM-6	52.00
Radio Shack DCM-7	85.00
Practical Peripheral 2400 Baud	229.00
Practical Peripheral 1200 Baud	149.00

COLOR COMPUTER MISC.

Radio Shack Drive Controller	99.00
Extended Basic Rom Kit	14.95
64K Ram Upgrade Kit	39.00
Radio Shack Deluxe Keyboard Kit	24.95
HI-RES Joystick Interface	8.95
Color Computer Deluxe Mouse	44.00
Multi Pak Interface	89.00
Multi Pak Pal Chip for COCO 3	14.95
CM-8 6' Extension Cable	19.95
Serial to Parallel Conv.	59.95
Radio Shack Deluxe Joystick	26.95
Magnavox 8515 RGB Monitor	329.00
Radio Shack CM-8 RGB Monitor	249.00
Radio Shack VM-4 Green Monitor	99.00
PBJ 512K COCO 3 Upgrade	99.00
Tandy 512K COCO 3 Upgrade	129.00
Mark Data Universal Video Driver	29.95

COLOR COMPUTER SOFTWARE

	TAPE	DISK
The Wild West (CoCo3)	25.95	34.95
Worlds Of Flight	34.95	34.95
Mustang P-51 Flight Simul.	34.95	34.95
Flight 16 Flight Simul.	34.95	34.95
COCO Util II by Mark Data	39.95	

COCO Max II by Colorware	79.95
COCO Max III by Colorware	79.95
AutoTerm by PXE Computing	29.95
TelePatch III by Spectrum	29.95
TW-80 by Spectrum (CoCo3)	39.95
TeleWriter 64	49.95 59.95
Elite Word 80	79.95
Elite Calc 3.0	69.95
CoCo3 512K Ram Disk by CerComp	19.95
Home Publisher by Tandy (CoCo3)	35.95
Sub Battle Sim. by Epyx (CoCo3)	26.95
Thexder by Sierra (CoCo3)	22.45
Kings Quest III by Sierra (CoCo3)	31.45
Flight Sim. II by SubLogic (CoCo3)	31.45
OS-9 Level II by Tandy	71.95
OS-9 Development System	89.95
Multi-View by Tandy	44.95
VIP Writer (disk only)	69.95
VIP Integrated Library (disk)	149.95

*Sale prices through 5/30/88

Prices are subject to change without notice. Please call for shipping charges. Prices in our retail store may be higher. Send for complete catalog.

**CALL TOLL FREE
1-800-343-8124**

- LOWEST POSSIBLE PRICES
- BEST POSSIBLE WARRANTY
- KNOWLEDGEABLE SALES STAFF
- TIMELY DELIVERY
- SHOPPING CONVENIENCE



computer plus

P.O. Box 1094
480 King Street
Littleton, MA 01460

SINCE 1973

IN MASSACHUSETTS CALL (617) 486-3193

RAINBOW

Table of Contents

May 1988
Vol. VII No. 10

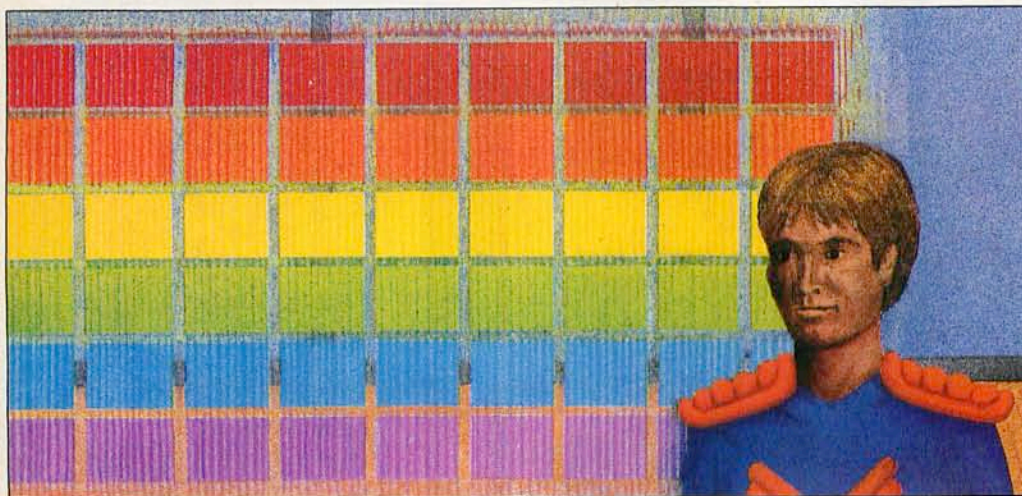

20

Features

20

Strata

Michael T. Sirolli
A fast-paced action game

30

One Good Turn Deserves Another

Eric Tucker
A strategy game for two players

36

Ye Olde Font

Bill Bernico
Graphics print font styles

42

CoCo 3 Color Dump

Duane M. Perkins
Dumping CoCo 3 graphics screens to the CGP-220

52

Sign In, Please!

Jim Bennett
Using the CoCo to copy your signature

58

PMODE Polychrome

Tracy L. Skaggs
Dumping PMODE 3 and 4 screens in color

95

Printing in Two Columns

Charles E. Brown, Jr.
Eye-catching newsletters with a two-column format

100

The Ins and Outs of Boolean

Eric Levinson
Binary math practice

104

The LLISTing Formatter

Clay Howe
A useful utility for LLISTing shortcuts

110

Printer Overview

Ed Ellers
A look at six printer types

114

Center That Header

Doug Anderson
Transferring centered headings to the DMP-110

116

Bulletin Board Standout

George Quellhorst
Printing posters with the DMP-130

146

The CoCo Power User

Alan J. Corson
The CoCo 3 as an effective office automation tool

150

Static RAM Interface

Dennis H. Weide
A RAM pack for your CoCo ROM port

155

Adding the HPRINT Capability to PMODE 4

Douglas Pokorny
Printing on the PMODE 4 graphics screen

164

Formatting Text With Telewriter

Jose L. Jimenez
An easy way to produce good-looking documents

52



The cassette tape/disk symbols beside features and columns indicate that the program listings with those articles are on this month's RAINBOW ON TAPE and RAINBOW ON DISK. Those with only the disk symbol are not available on RAINBOW ON TAPE. For details, check the RAINBOW ON TAPE and RAINBOW ON DISK ad on Page 119.

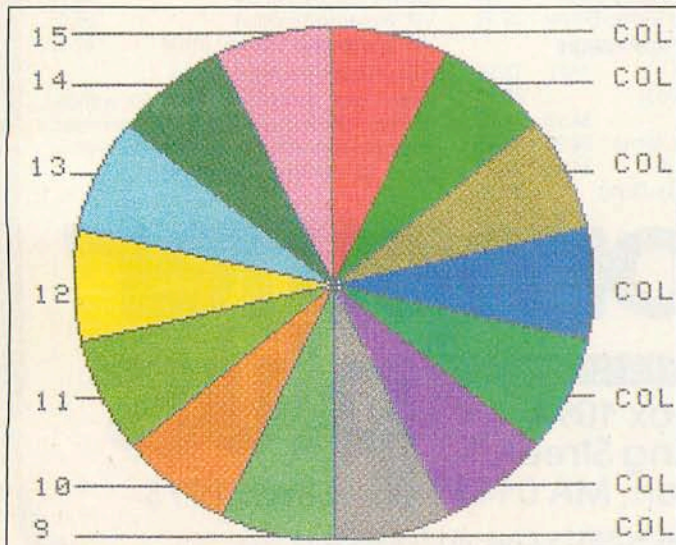

Novices Niche

90
Non-Smoking Section
 Ana M. Rodriguez

91
CoCo 3 Canvas
 George and Ellen
 Aftamonow

91
Ticket Maker
 Ed Schenck

92
Graphics Reference Chart
 Daniel T. Weaver

92
A Full-Page Dump for the DMP-105
 John Handis

93
Color in 32 Columns
 Chuck Katsekas

93
Phrase Centerer
 Gip Wayne Plaster, II

94
Blockout Wipeout
 Tony Owens

Departments

Advertisers Index	192
Back Issue Information	97
CoCo Gallery	18
Corrections	154
Letters to Rainbow	6
Maxwell Mouse	25
One-Liners	14, 33, 188, 189
One-Liner Contest Information	182
Racksellers	190
Rainbow Info	10
Received & Certified	140
Scoreboard	78
Scoreboard Pointers	80
Submitting Material to Rainbow	184
Subscription Info	16

Columns

82
BASIC Training
 Joseph Kolar
Swamp think

16
Building May's Rainbow
 Jutta Kapfhammer
Managing Editor's notes

158
CoCo Consultations
 Marty Goodman
Just what the doctor ordered

160
Delphi Bureau
 Cray Augsborg
What's in a file? and Hutchison's database report

148
Doctor ASCII
 Richard Esposito
The question fixer

88
Education Notes
 Steve Blyn
A review of synonyms, homonyms and antonyms

12
PRINT#-2,
 Lawrence C. Falk
Editor's notes

168
Turn of the Screw
 Tony DiStefano
Multi-Pak LED update

74
Wishing Well
 Fred Scerbo
Reading and decoding skills

Rainbowtech

170
Barden's Buffer
 William Barden, Jr.
The mystery of the Tandy anagram

178
KISSable OS-9
 Dale L. Puckett
Patches, programs and politics

Product Reviews

Astro Fortune Teller/Saint John Gallery	130
Data Master/Computerware	128
Indiana Jim/Lomiq, Inc.	138
Laser Surgeon:	
The Microscopic Mission/Activision	126
Lot-Pro/CJN Enterprises	130
OS-9 Development System/Tandy Corporation	132
The Rat/Diecom Products	137
REMusic/Codis Enterprises	136
Telewriter-128/Cognitec	133
Textform/R.A.D. Products	131
Tomb of T'ien/Valkyrie Software	129

THE RAINBOW is published every month of the year by FALSOFT, Inc., The Falsoft Building, 9509 U.S. Highway 42, P.O. Box 385, Prospect, KY 40059, phone (502) 228-4492. THE RAINBOW, RAINBOWfest and THE RAINBOW and RAINBOWfest logotypes are registered trademarks of FALSOFT, Inc. • Second class postage paid Prospect, KY and additional offices. USPS N. 705-050 (ISSN No. 0746-4797). POSTMASTER: Send address changes to THE RAINBOW, P.O. Box 385, Prospect, KY 40059. Authorized as second class postage paid from Hamilton, Ontario by Canada Post, Ottawa, Ontario, Canada. • Entire contents copyright © by FALSOFT, Inc., 1988. THE RAINBOW is intended for the private use and pleasure of its subscribers and purchasers and reproduction by any means is prohibited. Use of information herein is for the single end use of purchasers and any other use is expressly prohibited. All programs herein are distributed in an "as is" basis, without warranty of any kind whatsoever. • Tandy, Color BASIC, Extended Color BASIC and Program Pak are registered trademarks of the Tandy Corp. • Subscriptions to THE RAINBOW are \$31 per year in the United States. Canadian rates are U.S. \$38. Surface mail to other countries is U.S. \$68, air mail U.S. \$103. All subscriptions begin with next available issue. • Limited back issues are available. Please see notice for issues that are in print and their costs. Payment accepted by VISA, MasterCard, American Express, cash, check or money order in U.S. currency only. Full refund after mailing of one issue. A refund of 10/12ths the subscription amount after two issues are mailed. No refund after mailing of three or more magazines.

The Rainbow

Editor and Publisher
 Lawrence C. Falk

Managing Editor Jutta Kapfhammer
 Associate Editor Jody Gilbert
 Reviews Editor Lauren Willoughby
 Submissions Editor Angela Kapfhammer
 Copy Editor Sue Fomby
 Technical Editors Cray Augsborg,
 Ed Ellers
 Editorial Assistants Sue H. Evans,
 Wendy Falk, Monica Wheat
 Contributing Editors
 William Barden, Jr.,
 Steve Blyn, Tony DiStefano,
 Richard Esposito,
 Martin Goodman, M.D.,
 Joseph Kolar, Dale Puckett,
 Fred Scerbo, Richard White
 Art Director Heidi Maxedon
 Designers Robert Hatfield, Jr.,
 Denise Webb
 Typesetter Jody Doyle

Falsoft, Inc.

President Lawrence C. Falk
 General Manager Bonnie Frowenfeld
 Asst. General Mgr. for Finance
 Donna Shuck
 Admin. Asst. to the Publisher
 Sarah Levin
 Editorial Director John Crawley
 Asst. Editorial Director Judi Hutchinson
 Executive Editor James E. Reed
 Senior Editor T. Kevin Nickols
 Production Coordinator
 Cynthia L. Jones
 Chief Bookkeeper Diane Moore
 Dealer Accounts Judy Quashnock
 Asst. General Manager For Administration
 Sandy Apple
 Word Processor Manager
 Patricia Eaton
 Customer Service Representative
 Beverly Beardon
 Development Coordinator Ira Barsky
 Chief of Printing Services Melba Smith
 Director of Production Jim Cleveland
 Dispatch Tony Olive, Sharon Smith
 Business Assistant Laurie Falk
 Advertising Coordinator Doris Taylor
 Advertising Representatives
 Belinda Kirby, Kim Vincent
 Advertising Assistant Debbie Baxter
 (502) 228-4492

For RAINBOW Advertising and
 Marketing Office Information,
 see Page 192

Cover photograph copyright © 1988
 by Carl Maupin
 Art direction by Heidi Maxedon

Editor:

Here are some comments relevant to the Rule of 78's that users of Jack W. Eizenga's program of the same name (March '88 RAINBOW, Page 100) may find of value.

The rule (also known as the Sum-of-the-Digits Method) has been outlawed in several states due to its unfairness to the consumer. The battle to defeat such a measure was led by lending institutions, which have managed to keep it intact in most other states. A few states have restricted its use to loan payback periods under three or four years.

A legal review article on R-78, originating at Boston University Law School, concludes it is unfair to consumers when interest rates are fairly high and payback term is fairly long, and especially when both these conditions exist. The article ends with a general plea to the legal community to help abolish the rule entirely.

The only notice in a loan contract that the Rule of 78's will be invoked on early payoff is a bare mention of the rule. By law, it has to be so mentioned, and can be found in the fine print if one looks closely. Lenders are *not* required to explain it and won't, unless pressed. Even then, most cannot offer an easy explanation because of the relative complexity of the concept and an understandable reluctance to reveal to a borrower how he or she will be ripped off (under certain conditions) if an early payoff becomes possible.

At least one supposedly authoritative source of information on the rule, a weighty tome called *Thorndike's Encyclopedia of Banking and Financial Tables*, is misleading in its comments on the rule. Essentially, it says that the approximate payoff figures of a loan are so close to those derived from the usual accrual method of amortization that any minor differences can be ignored. That statement is true for short-term loans with reasonable interest rates. It is totally false for long-term loans and higher interest rates — a fact not mentioned.

Mr. Eizenga seems to knuckle under a bit to the lenders in his statement that calculating the Rule of 78's won't keep you from having the penalty assessed but will keep you from suffering an unpleasant surprise if you pay off early. Paying the penalty doesn't necessarily have to happen. There have been several cases of the rule being challenged successfully, based on the rationale that use of the rule constitutes a *hidden prepayment penalty* directly conflicting with other language in most contracts, which says there isn't any prepayment penalty. Last year, such a battle was won by the undersigned on exactly that basis against a bank that was, because of the Rule of 78's, demanding some \$900 more in payoff than actually fairly owed for the time elapsed (4.6 years) on a 10-year loan.

In connection with that battle, the CoCo 2 played a major role, running a Rule of 78's

amortization schedule and regular amortization schedules for comparisons the bank could not refute. The regular amortization schedule program used was the one by Bill Barden on Page 5 of his book, *TRS 80 Color Computer & MC-10 Programs*. The R-78 amortization program was an adaptation of Barden's program, needing only minor formula and heading changes. Combining the two programs was to have been a programming project, but Jack Eizenga's nifty program saves that effort. I wish I'd had it at the time! Thank you for featuring it and Jack for writing it. It is a valuable addition to the financial programs disk here at home.

I hope these comments help someone else disadvantageously involved or about to be involved with the Rule of 78's. The best way to avoid being penalized by it is to be sure it is not in your loan contract. Lenders are in the business of making money. If you are a decent financial risk, you can threaten to walk out on any new, to-be-signed contract with the Rule of 78's mentioned as applicable if you pay off early. Chances are good the lender will swiftly present another contract for your signature, one which doesn't call for the pesky R-78 and treats you fairly if you pay off early.

Bob Tatam
Mobile, AL

REVIEWING REVIEWS

Editor:

My thanks to Jerry Semones for his review of *GrafFind* in the April '88 issue. My only disappointment was his failure to mention the 39 digitized pictures that are included on the program disk. This is no small matter when picture disks are going for \$10 to \$20 for 20 or so pictures. Thank you again for a delightful review.

D. Steven Ricketts
President
RainyDay Software
Boring, OR

HINTS AND TIPS

Editor:

In the January '88 issue of RAINBOW there appeared a hardware project titled "Child-Proofing the CoCo." This project made a keyboard-locking switch that would prevent children from messing up your programs.

I found that basically the same thing could be done with one simple poke. Just type `POKE &HFF0F, &HF0`.

That locks the keys so that nothing can be typed. To put everything back to normal, just press the reset button.

Glen Johnsrud
Lorette, Manitoba

Battling Cassette I/O Errors

Editor:

I am saving up for a disk drive. Until then, I am using my Realistic CTR-65 cassette recorder to store files. Lately I have been having a terrible time with I/O Errors. Here are some tips I have found to be helpful.

First, some I/O Errors can be "fixed" by unplugging the gray AUX plug when doing a CLOAD. Second, you want to unplug the black EAR plug when making CSAVEs. Why? On my machine, and most other recorders not specifically designed for computer use, the earphone jack is used as a monitor output when recording from radio or microphone. Apparently there isn't sufficient separation of the "mic" and "ear" circuits in the CoCo's cassette interface, and a small hum records on the tape along with the audio input from the CoCo as it records the program.

Terry F. Phillips, Sr.
Elkhart, IN

Clean Machine

Editor:

I read and enjoy every issue of THE RAINBOW, and I learn something from each one. I believe we are *all* beginners, never fully able to master our Color Computers. I was especially glad to see "A Glossary of Computer Terms" by Lee Veal in the January 1988 issue. I think this should have been in the magazine years ago. Even though I've had a CoCo for over six years, I am still learning. In fact, I learned that the "RS" in "RS-232" means "Recommended Standard," *not* "Radio Shack."

I have a hint on cleaning the CoCo's keyboard: Use a dry, skinny paint brush, like one that comes with paint-by-number sets, to remove dust, hair, etc., from between the keys. I also use one to clean the printer.

Also, use the following hint on the CoCo 3 to CLOAD or CLOADM programs from tape if you don't know the exact start. It saves entering CLOAD over and over. You don't need to specify the name of the program:

```
1 ON ERR GOTO 4
2 CLOAD(M)
3 END
4 RUN
```

Lee Deuell
Shell Rock, IA

Buyer Beware

Editor:

You won't find me on your subscription list. I have been buying your magazine every month at the local B. Dalton Booksellers since getting my first CoCo two years ago. I let my fingers do the walking through THE RAINBOW when I do my shopping.

Microcom, Colorware, Micro Works, just

RUNS ON
COCO 2 & 3

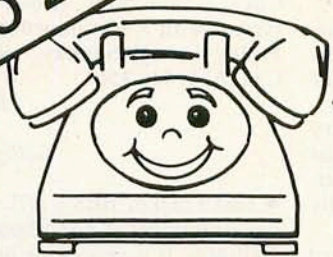

AUTOTERM

URNS YOUR COLOR COMPUTER INTO THE

WORLD'S SMARTEST TERMINAL!



YOU'LL ALSO USE AUTOTERM FOR SIMPLE
WORD PROCESSING & RECORD KEEPING

EXTRA FEATURES ON COCO 3 DISK

80 char. screen, 2400 baud thru serial port,
95,000 to 475,000 character buffer.

EASY COMMUNICATION + WORD PROCESSING + TOTAL AUTOMATION

Full prompting and error checking. Step-by-step manual has examples. Scroll text backward and forward. No split words on screen or printout. Save, load, delete files while on line. Print, save all or any part of text. 300 or 1200 baud. All 128 ASCII characters. Works with D.C. Hayes or any modem. Screen widths of 32, 40, 42, 51, 64.

DISK VERSION SUPPORTS RS232 PAK, XMODEM and SPLIT SCREEN FOR PACKET RADIO.

Please hire the mentally retarded. They are sincere, hard working and appreciative. *Thanks!*

Phyllis.

Editing is super simple with the cursor. Find strings instantly too! Insert printer control codes. Specify page size and margins. Switch quickly between word processing and intelligent terminal action. Create text, correct your typing errors; then connect to the other computer, upload your text or files, download information, file it, and sign-off; then edit the receive data, print it in an attractive format, and/or save it on file. Compatible with TELEWRITER.

CASSETTE \$29.95

DISKETTE \$39.95

Add \$3 shipping and handling
MC/VISA/C.O.D.

Advanced system of keystroke macros lets you automate any activity, such as dial via modem, sign-on, interact, sign-off, print, save. Perform entire session. Act as message taker. At start-up, disk version can automatically set parameters, dial, sign-on, interact, read/write disk, sign-off, etc. Timed execution lets AUTOTERM work while you sleep or play. No other computer can match your COCO's intelligence as a terminal.

PXE Computing
11 Vicksburg Lane
Richardson, Texas 75080
214/699-7273

to name a few, have been very good to me; great products, fast delivery. Now, the problem:

Spectrum Projects, an advertiser of yours, is selling a 512K CoCo 3 sticker for \$4.99 plus a \$3 shipping charge. You might think you're getting the metal "Tandy" plate, but what you actually get is roughly a 2½-by-¾-inch adhesive foil tape with "512K CoCo" printed in tiny font with a black background. And no matter how careful you are, the black rubs off.

I can get these stickers printed locally for nine cents each. Plus, they [Spectrum] do general 4th Class mail, you know, "Some day delivery" for about 22 cents.

Also, I cannot see why Spectrum would market a fine product like *The Schematic Processor* with the original programmer's notes. Can't the folks at Spectrum type? It sure would make it seem like you're dealing with a respectable company.

If you don't choose to print this letter, I understand. But CoCo users should be aware of how much of a ripoff this really is.

Robert N. Carman II
Omaha, NE

We have received a number of complaints regarding Spectrum Projects. However, effective with the March '88 issue, Spectrum Projects no longer advertises its products in THE RAINBOW. And according to a letter some of our advertisers have received from Spectrum Projects, it is no longer doing business. Any complaints about this mail order

business should be directed to: The Postmaster General, Howard Beach, NY 11414.

KUDOS

Editor:

I am just writing to compliment Dave Archer on his "Number Cruncher" *SUM128* program. I should have written in about some other programs long ago, as I have enjoyed many of them; this one I have modified, and it is very useful to me. I bought my first RAINBOW in January 1983 and subscribed to it a few months later. I also subscribed to RAINBOW ON TAPE until the disk version was available. Thanks for a great magazine. A Louisville RAINBOW-fest sounds good, also.

Lyle Warner
Flint, MI

A Satisfied Customer

Editor:

I just wanted to tell you how delightful it has been dealing with one of your advertisers, S.D. Enterprises, and its flagship product, *VIP Writer III*. When I initially called with a multitude of questions, Paul Anderson at S.D.E. was very patient and spent a good deal of time on the phone answering all the questions I had. To top it off, when he heard of my disappointment with another CoCo 3 word processor, he offered me a \$30 credit toward *VIP Writer III* if I sent in the one I didn't like with my order. To my

knowledge, S.D.E. is extending this offer to others. Since my order arrived I have been in contact with Mr. Anderson with suggestions on how to improve *VIP Writer III's* operation from a user's standpoint. Not only are the people at S.D.E. eager to listen to what the customer has to say, they are presently updating the program, incorporating some of these suggestions from myself and others. S.D. Enterprises is an excellent example of a good mail-order firm, which others would be wise to emulate.

Donald S. Ricketts
Boring, OR

Successful Operation

Editor:

I bought a monitor from one of your advertisers, Howard Medical, out of Chicago. I received the equipment in a week, but it did not work. I called the company, and they shipped me a replacement the next working day. It is the sort of excellent service that makes mail-order electronics possible and successful. Kudos to Howard Medical!

Dennis L. Wood
Indianapolis, IN

A Phonics Fan

Editor:

Thank you for Steve Blyn's phonics program in the March 1988 issue ("Fun With Phonics," Page 89). It is the ideal program for my use. I direct a tutorial program for over 100 at-risk elementary students. We

have three 16K CoCos and one 16K ECB CoCo. I have copied and adapted as many programs as I can find, but *Phonics* was one of the best.

Phonics is open-ended, so the tutor or student can determine when to terminate the exercise. It is short, so the amateur (myself) can type it in and save it to tape, identify an error and rectify it immediately, or easily change it from 16K ECB to just 16K by rewriting the sound line (Line 170).

One program like that each month would totally justify the expenditure for RAINBOW.

Ann Schwendener
Director, Tutorial Program
The Salvation Army
Kalamazoo, MI

Colorful Praise for RGB

Editor:

Your new advertiser, RGB Computer Systems, provides an exceptional product, a hard disk that is truly 100 percent BASIC-compatible, can be partitioned for OS-9 and runs on all CoCos.

In addition to producing an excellent product, the people at RGB are accessible, knowledgeable and generous with their help. *What else?* They send at least \$150 worth of nonessential, but very helpful, utilities in the bargain.

If I were to provide a CoCo product, I would want it to be as good as RGB's hard disk system. With RGB, one gets more than what is expected.

Jim DeStafeno
Wyoming, DE

PEN PALS

• I am looking for pen pals anywhere in the U.S.A. I have a CoCo 2, double drives, DMP-105 printer and recorder. I will respond to all letters. I am 12 years old.

Chris Noles
2525 Quail Run
Marietta, GA 30060

• I am 19 years old and have a 64K ECB CoCo I, new CoCo 3, disk drive, RS Speech Pak, Multi-Pak and a DMP-130A. I will answer *all* letters.

Nicholas Siclari
58 Vanderbilt Ave.
Staten Island, NY 10304

• I am 16 and have a CoCo 2, CCR-81 and a DMP-106. I also collect stamps. I write a lot of programs myself. I would like some pen pals my age.

David Hamby
1507 W. 17th
Hutchinson, KS 67501

• I have a CoCo 3, FD 501 and DMP-106, and would like to hear from anyone in the U.S.A. I like Adventures and programming in BASIC.

George Leal
P.O. Box 2232
Victoria, TX 77902

• I'm 10 years old and have a CoCo 3, a disk drive, a DMP-130 printer and a DCM-6 modem. I'm looking for a pen pal of any age. I will answer *all* letters.

Sam Newlands
130 Galiano St.
Royal Palm Beach, FL 33411

• I am a 15-year-old Boy Scout and am very interested in computers. I own a 128K Color Computer 3 and a CCR-81 cassette recorder. I like almost all types of games, especially golf games.

Jamie Stafford
4615 Rockcut Road
Norton, OH 44203

• Greetings! I have a 128K Color Computer 3 with one FD-501 drive, a DMP-105 printer, a DCM-5 auto modem, and green-screen monitor. I am 23 years old and have OS-9 Level I and BASIC09.

Eric Silnes
1317 Edgewood #1
Grafton, ND 58237

BULLETIN BOARD SYSTEMS

• There's a BBS in the Toronto area dedicated to the Color Computer. Remote Data Systems-09 has been in operation for almost two years. We have a large array of public domain software for downloading and have several knowledgeable users on such topics as OS-9. New users with new ideas are always welcome. Please call RDS-09 at (416) 283-7521. 2400/1200/300 bps, 8 data bits, no parity, 1 stop bit, 24 hours a day.

Doug V. Wright
291 Rouge Hills Dr.
Scarborough, Ontario
Canada M1C 2Z2

• The Portage Railroad Bulletin Board is open 24 hours a day at (814) 944-6588. It supports 300/1200/2400 baud. Settings should be 8 bits, full duplex, no parity. It is an IBM board, but we have a Color Computer SIGop in Conference #4.

William A. Smith
P.O. Box 101
Roaring Spring, PA 16673

• I am happy to announce that the Frisky CoCo BBS, which has been online for four years, has graduated from the 64K, three double-sided 40-track drives to a PC clone with a 62-Meg hard drive. There is a PC SIG and files, but the focus is still on Tandy's CoCo. Call (816) 436-2904, 7 days a week, 24 hours a day at 300, 1200 or 2400 baud.

Jerry Oliver, SysOp
The Frisky CoCo BBS
839 NW 69th Pl.
Kansas City, MO 64118

• I would like to let everyone know of three local BBSs in the area. First is The Rainbow's End, running at 300/1200 baud, which has five online games and plenty of downloads (public domain). Call (614) 446-7430. Online Friday through Sunday, 6 p.m. to midnight. The second is The Rabbit's Hole, running at 300 baud, online Monday

through Friday, 2 p.m. to midnight. It has one online game and a few downloads (also public domain). Call (614) 367-0128. Last is CoCo Connections. It is a 300/1200 baud system with a few downloads. It is online Friday through Sunday, midnight to 6 a.m. Call (614) 446-1564.

Robert J. Grubb
Rt. 4, Box 309
Gallipolis, OH 45631

• Fast Trackin' BBS is *offline*. Please do not call its number as published in past issues of RAINBOW. It is now being operated by Jerry Downey in Hopkinsville, Kentucky, as the Midnite Express, (502) 885-4335. It runs 24 hours, 300/1200 baud 7E1. I hope to bring Fast Trackin' BBS back online someday.

David Guess
1292B Barnwood Court
Bowling Green, KY 42101

• My BBS runs on *CoBBS* modified to work under Stearman DOS. Some of the features include a faster running board, better error-trapping and machine language Xmodem upload and download routines. New users can reach the board at (615) 476-3340. It is running 24 hours a day at 300 and 1200 baud. Terminal parameters should be set at 8 bits, no parity, 1 stop bit (8N1).

Brian S. Graham
Rt. 2, Box 1036
Cleveland, TN 37311

• The Dungeon BBS of Newport, North Carolina, is now online at 300/1200/2400 baud, 24 hours a day. The board features games, Hi-Res graphics, multiple message bases, special interest groups, Shop and Swap, upload and download areas for CoCo, IBM, Apple, Commodore, Tandy and Atari computers, national network news and even a professional technical section. Call (919) 726-9737.

Chuck Katsekas
410 Scott Drive
Newport, NC 28570

• The Fine Art Treatise (FAT) BBS is running under *CoBBS* at 300/1200 baud, 24 hours. There are no fees, and a first-time caller has nearly full access. Featuring ASCII downloads, literature, crossword, Never-Ending Story. Call (513) 778-9624.

Jack Bowman
1010 Concord Ave.
Piqua, OH 45356

THE RAINBOW welcomes letters to the editor. Mail should be addressed to: Letters to Rainbow, The Falsoft Building, P.O. Box 385, Prospect, KY 40059. Letters should include the writer's full name and address. Letters may be edited for purposes of clarity or to conserve space.

Letters to the editor may also be sent to us through our Delphi CoCo SIG. From the CoCo SIG> prompt, type RAI to take you into the Rainbow Magazine Services area of the SIG. At the RAINBOW> prompt, type LET to reach the LETTERS> prompt and then select Letters for Publication. Be sure to include your complete name and address.



Word Power 3.1

(The Ultimate Word Processor for the CoCo 3)

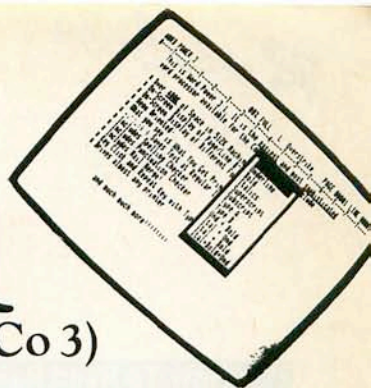

Power Unleashed! Unlike other word-processors, Word Power 3.1 is written from scratch for the CoCo3. It bridges the gap between "what is" and "what should be" in word-processors. **No other word processor offers such a wide array of features that are so easy to learn and use.**

DISPLAY

The 80-column display with true lowercase lets you view the full width of a standard page. **All prompts are displayed in plain English in neat colored windows** (see display above). The current column number, line number, page number and percentage of free memory is displayed on the screen at all times. The program even **displays the bottom margin perforation** so you know where one page ends and the other begins. You can also change foreground/background color of screen and select menu and carriage return colors to suit your needs! Carriage returns can be visible or invisible. Word Power 3.1 runs at double clock speed and can be used with RGB/composite/monochrome monitors as well as TV.

AVAILABLE MEMORY

No other word processor gives you so much memory. Word Power 3.1 gives you **over 72K** on a 128K machine and **over 450K** on a 512K machine to store text

EDITING FEATURES

Word Power 3.1 has one of the **most powerful and user-friendly full-screen editors with word-wrap**. All you do is type. Word Power 3.1 takes care of the text arrangement. It even has a built-in **Auto-Save** feature which saves the current text to disk at regular intervals; so you know that your latest version is saved to disk. Here are some of the impressive editing features of Word Power 3.1:

Insert/Overstrike Mode (Cursor style changes to indicate mode); OOPS recall during delete; **Type-ahead buffer** for fast typers; Key-repeat (adjustable) and Key-click; Four-way cursor control and scrolling; Cursor to beginning of text, end of text, beginning of line, end of line, top/bottom of screen, next/previous word; Page up/down; Delete character, previous/next word, beginning/end of line, complete line, text before and after cursor; Locate/Replace with **wild-card search** with auto/manual replace; Block Mark, Unmark, Copy, Move and Delete; Line Positioning (Left/Center/Right); Set/Reset 120 programmable tab stops; Word count. Define left, right, top and bottom margins and page length. You can also highlight text (underline - with **on-screen underlining**, bold, italics, superscripts, etc). Word Power 3.1 even has a **HELP** screen which can be accessed any time during edit.

MAIL-MERGE

Ever try mailing out the same letter to 50 different people or sending out several resumes? Could be quite a chore. Not with Word Power 3.1. Using this feature, you can type a letter, follow it with a list of addresses and have Word Power 3.1 print out personalized letters. It's that easy!

SAVING/LOADING TEXT

Word Power 3.1 creates ASCII format files which are compatible with almost all terminal, spell-checking and other word-processing programs. It allows you to load, save, append and kill files and also to create and edit Basic, Pascal, C and Assembly files. You can select files by simply cursoring through the disk directory. Supports double-sided drives and various step rates.

PRINTING

Word Power 3.1 drives almost any printer (DMP series, EPSON, GEMINI, OKIDATA, etc). Allows print options such as baud rates, line spacing, page pause, partial print, page numbers, page number placement, linefeed option, multi-line headers/footers, right justification and number of copies (see display above). The values for these parameters and the margins can be changed anytime in the text by embedding Printer Option Codes. Word Power 3.1 has the **WHAT YOU SEE IS WHAT YOU GET** feature which allows you to preview the text on the screen as it will appear in print. You can see margins, page breaks, justification and more.

SPELLING CHECKER

Word Power 3.1 comes with a 50,000 word spelling checker/dictionary which finds and corrects mistakes within your text. You can add words to or delete from the dictionary or create a dictionary of your own.

PUNCTUATION CHECKER

This checker will **proofread your text for punctuation errors** such as capitalization, spaces after periods/commas, double words and much more. It's the perfect addition to any word processor.

DOCUMENTATION

Writing with Word Power 3.1 is a breeze. Word Power 3.1 comes with a well-written, easy-to-comprehend instruction manual which will lead you step-by-step through the program.

Word Power 3.1 comes on an UNPROTECTED disk and is compatible with RS DOS 1.0/1.1 and ADOS. Only \$79.95.

(Word Power 3 owners can get the 3.1 version by sending proof of purchase and \$10.00 to cover the cost of shipping and the manual.)



MICROCOM SOFTWARE

P.O. Box 214

Fairport, NY 14450

Phone (716) 223-1477

To Place Credit Card Orders Call Toll Free 1-800-654-5244 9 AM-9 PM EST 7 days a week

NY, Canada, Foreign Orders, Information, Technical Advice and Order Status call 1-716-223-1477

All orders within Continental US shipped by UPS 2nd Day Air at no extra charge.

VISA, MC, AMEX, Check, MO. No CODs. Please add \$3.00 S&H (USA & Canada), other countries \$5.00 S&H. NYS residents please add sales tax.



How To Read Rainbow

When we use the term CoCo, we refer to an affectionate name that was first given to the Tandy Color Computer by its many fans, users and owners.

The BASIC program listings printed in THE RAINBOW are formatted for a 32-character screen — so they show up just as they do on your CoCo screen. One easy way to check on the accuracy of your typing is to compare what character "goes under" what. If the characters match — and your line endings come out the same — you have a pretty good way of knowing that your typing is accurate.

We also have "key boxes" to show you the *minimum* system a program needs. But, *do* read the text before you start typing.

Finally, the little disk and/or cassette symbols on the table of contents and at the beginning of articles indicate that the program is available through our RAINBOW ON DISK or RAINBOW ON TAPE service.

Using Machine Language

The easiest way to "put" a machine language program into memory is to use an editor/assembler, a program you can purchase from a number of sources. All you have to do, essentially, is copy the relevant instructions from THE RAINBOW's listing into CoCo.

Another method of putting an ML listing into CoCo is called "hand assembly" — assembly by hand, which *sometimes* causes problems with ORIGIN or EQUATE statements. You ought to know something about assembly to try this.

Use the following program if you want to hand-assemble ML listings:

```
10 CLEAR200,&H3F00:I=&H3FB0
20 PRINT "ADDRESS: ";HEX$(I);
30 INPUT "BYTE ";B$
40 POKE I, VAL("&H"+B$)
50 I=I+1:GOTO 20
```

This program assumes you have a 16K CoCo. If you have 32K, change the &H3F00 in Line 10 to &H7F00 and change the value of I to &H7FB0.

OS-9 and RAINBOW ON DISK

The OS-9 side of RAINBOW ON DISK contains two directories: CMDS and SOURCE. It also contains a file, *read.me.first*, which explains the division of the two directories. The CMDS directory contains executable programs and the SOURCE directory contains the ASCII source code for these programs. BASIC09 programs will only be offered in source form so they will only be found in the SOURCE directory.

OS-9 is a very powerful operating system. Because of this, it is not easy to learn at first. However, while we can give specific instructions for using the OS-9

programs, you will find that the OS-9 programs will be of little use unless you are familiar with the operating system. For this reason, if you haven't "learned" OS-9 or are not comfortable with it, we suggest you read *The Complete Rainbow Guide to OS-9* by Dale Puckett and Peter Dibble.

The following is not intended as a course in OS-9. It merely states how to get the OS-9 programs from RAINBOW ON DISK to your OS-9 system disk. Use the procedures appropriate for your system. Before doing so, however, boot the OS-9 operating system according to the documentation from Radio Shack.

- 1) Type `load dir list copy` and press ENTER.
- 2) If you have only one disk drive, remove the OS-9 system disk from Drive 0 and replace it with the OS-9 side of RAINBOW ON DISK. Then type `chd/d0` and press ENTER. If you have two disk drives, leave the system master in Drive 0 and put the RAINBOW ON DISK in Drive 1. Then type `chd/d1` and press ENTER.
- 3) List the `read.me.first` file to the screen by typing `list read.me.first` and pressing ENTER.
- 4) Entering `dir` will give you a directory of the OS-9 side of RAINBOW ON DISK. To see what programs are in the CMDS directory, enter `dir cmds`. Follow a similar method to see what source files are in the SOURCE directory.
- 5) When you find a program you want to use, copy it to the CMDS directory on your system disk with one of the following commands:

One-drive system: `copy /d0/cmds/ filename /d0/cmds/ filename -s`

The system will prompt you to alternately place the source disk (RAINBOW ON DISK) or the destination disk (system disk) in Drive 0.

Two-drive system: `copy /d1/cmds/ filename /d0/cmds/ filename`

Once you have copied the program, you execute it from your system master by placing that disk in Drive 0 and entering the name of the file.

The Rainbow Seal



The Rainbow Certification Seal is our way of helping you, the consumer. The purpose of the Seal is to certify to you that any product that carries the Seal has actually been seen by us, that it does, indeed, exist and that we have a sample copy here at THE RAINBOW.

Manufacturers of products — hardware, software and firmware — are encouraged by us to submit their products to THE RAINBOW for certification.

The Seal is not a "guarantee of satisfaction." The certification process is different from the review process. You are encouraged to read our reviews to determine whether the product is right for your needs.

There is absolutely no relationship between advertising in THE RAINBOW and the certification process. Certification is open and available to any product per-

taining to CoCo. A Seal will be awarded to any commercial product, regardless of whether the firm advertises or not.

We will appreciate knowing of instances of violation of Seal use.

Rainbow Check Plus

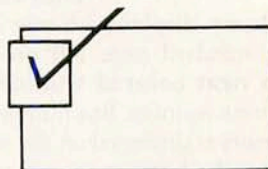

The small box accompanying a program listing in THE RAINBOW is a "check sum" system, which is designed to help you type in programs accurately.

Rainbow Check PLUS counts the number and values of characters you type in. You can then compare the number you get to those printed in THE RAINBOW. On longer programs, some benchmark lines are given. When you reach the end of one of those lines with your typing, simply check to see if the numbers match.

To use *Rainbow Check PLUS*, type in the program and save it for later use, then type in the command `RUN` and press ENTER. Once the program has run, type `NEW` and press ENTER to remove it from the area where the program you're typing in will go.

Now, while keying in a listing from THE RAINBOW, whenever you press the down arrow key, your CoCo gives the check sum based on the length and content of the program in memory. This is to check against the numbers printed in THE RAINBOW. If your number is different, check the listing carefully to be sure you typed in the correct BASIC program code. For more details on this helpful utility, refer to H. Allen Curtis' article on Page 21 of the February 1984 RAINBOW.

Since *Rainbow Check PLUS* counts spaces and punctuation, be sure to type in the listing exactly the way it's given in the magazine.

```
10 CLS:X=256*PEEK(35)+178
20 CLEAR 25,X-1
30 X=256*PEEK(35)+178
40 FOR Z=X TO X+77
50 READ Y:W=W+Y:PRINT Z,Y:W
60 POKE Z,Y:NEXT
70 IF W=7985 THEN B0 ELSE PRINT
  "DATA ERROR":STOP
80 EXEC X:END
90 DATA 182, 1, 106, 167, 140, 60, 134
100 DATA 126, 183, 1, 106, 190, 1, 107
110 DATA 175, 140, 50, 48, 140, 4, 191
120 DATA 1, 107, 57, 129, 10, 38, 38
130 DATA 52, 22, 79, 158, 25, 230, 129
140 DATA 39, 12, 171, 128, 171, 128
150 DATA 230, 132, 38, 250, 48, 1, 32
160 DATA 240, 183, 2, 222, 48, 140, 14
170 DATA 159, 166, 166, 132, 28, 254
180 DATA 189, 173, 198, 53, 22, 126, 0
190 DATA 0, 135, 255, 134, 40, 55
200 DATA 51, 52, 41, 0
```

COCO 3 UTILITIES GALORE

(All utilities support 40/80 columns for CoCo 3)
(CoCo 2 versions are available for most utilities)



SUPER TAPE/DISK TRANSFER



• Disk-to-Disk Copy (1-3 passes) • Tape-to-Disk Copy • Tape-to-Disk Automatic Relocate • Disk-to-Tape Copy • Tape-to-Tape Copy
Copies Basic/ML programs and DATA files. CoCo 1, 2 & 3. 32 K Disk System (Disk to Disk Copy requires 64 K). Disk Only \$24.95

OS9 LEVEL II RAMDISK

Lightning Fast Ramdisk with Auto Formatting. A must for any OS9 Level II User. Req. 512 K \$29.95. (Only \$14.95 with the purchase of 512K Upgrade & Ramdisk!!)

HI-RES JOYSTICK SOFTWARE

Wish you could use the hi-res joystick interface from Basic? You can now. This program will let you access 640 x 640 pixels from your joystick for extra precision. CoCo 3 Disk \$14.95

COCO NEWSROOM

Now available for the CoCo III! You can design your own newspaper with Banner Headlines/6 articles using sophisticated Graphics, Fonts and Fill Patterns. Comes with 22 fonts & 50 pictures! Over 140 K of code. Disk only \$49.95

MAILLIST PRO

The ultimate mailing list program. Allows you to add, edit, view, delete, change, sort (by zipcode or name) and print labels. Its indispensable! Disk Only \$19.95 (CoCo 2 version included)

DISK LABEL MAKER

Allows you to design professional disk labels! Allows elongated, normal and condensed format for text, double-strike, border creation and multiple-label printing. Its a MUST for any user with a disk drive. Disk Only \$19.95. Supports DMP 105/110/120/130/430, GEMINI, STAR, EPSON and compatibles. (CoCo 2 version included)

COMPUTERIZED CHECKBOOK

Why bother with balancing your checkbook? Let the CoCo do it for you! Allows you to add, view, search, edit, change, delete and printout (in a table or individual entry format) checkbook entries. Updates balance after each entry. Allows files for checking, saving and other accounts. Disk Only \$19.95 (CoCo 2 version included)

BOWLING SCORE KEEPER

An excellent utility to keep track of your bowling scores. Allows you to save scores under individuals or teams. You can edit, change, delete and compare scores. A must for anyone who wants to keep track of his or her bowling performance. Disk \$19.95 (CoCo 2 version included).

VCR TAPE ORGANIZER

Organize your videocassettes with this program! Allows you to index cassettes by title, rating, type, play time and comments. Also allows you to sort titles alphabetically and view/print selected tapes. If you own a VCR, this program is a must. Disk Only \$19.95 (CoCo 2 version included).

SCREEN DUMP

32, 40, 80 column text dump, PMODE 4 Graphics Dump. Single Keystroke Operation allows you to take snapshots of screens even when programs are running! Works on DMP's, Epson and Gemini. CoCo 1, 2 and 3. Disk Only \$24.95



HOME BILL MANAGER

Let the CoCo keep track of your bills. Allows you to enter bills under various categories and reminds you when they are due. Disk Only \$19.95



CALENDAR MAKER

Generate monthly calendars on your printer for any year in the 20th century. Disk Only \$19.95



COCO UTIL II

(Latest Version): Transfer CoCo Disk files to IBM compatible computer. Transfer MS-DOS files to CoCo. Req. 2-Drive IBM compatible. \$39.95

SPIT 'N IMAGE

Makes a BACKUP of ANY disk \$32.95

ADOS3

Advanced Disk Operating System for CoCo 3. \$34.95 ADOS \$27.95

RGB PATCH

Displays most games in color on RGB monitors. For CoCo 3 Disk \$24.95

OS 9 PRODUCTS

OS 9 LEVEL II OPERATING SYSTEM



Supports 512K RAM dual speed, multi-tasking, multiple windows and more! Comes with disk and complete documentation. Only \$89.95

MULTI-VUE

User friendly graphics interface with multiple "window" applications for Level II. Only \$54.95

WIZ

OS9 Level II Terminal Package with 300-19200 baud rate and windowing capability. Requires 512 K and RS-232 Pack. Only \$79.95

SCREEN STAR

Best OS9 Word Processor. Implements WordStar (R) editing capabilities. Even has a built in spelling checker. Use with OS-9 Text Formatter to get beautiful printouts. For OS9 Level 1 and 2. Disk Only \$49.95. OS-9 Text Formatter: Printout beautiful documents from any ASCII file. Only \$34.95. Both Screen Star and OS-9 Text Formatter: \$74.95

DATA MASTER

Excellent database for OS9. Features include: windows, pull down menus, sorting, etc. Requires OS9 Level II & 512K. Only \$64.95

PC-Xfer UTILITIES



Programs to format and transfer files to/from MS-DOS diskettes on CoCo Under OS9 Level 1 or 2. Requires SDISK or SDISK3. Only \$44.95

SDISK 3



Standard disk drive module replacement allows full use of 40/80 track double sided drives. Req. OS9 Level II. Only \$29.95

SDISK



Same as SDISK 3 except for OS9 Level I. Only \$29.95

OS9 LEVEL II RAMDISK

\$29.95

BOOKS

Inside OS9 Level II: \$39.95
Rainbow Guide To OS9 Level II: \$19.95
Rainbow Guide To OS9 Level II Disk: \$19.95
OS9 is a trademark of Microware and Motorola, Inc.



MICROCOM SOFTWARE
P.O. Box 214
Fairport, N.Y. 14450
Phone (716) 223-1477



All orders \$50 and above shipped by UPS 2nd Day Air within Continental US at no extra charge. No CODs. We accept Visa, MC, Amex, Check or MO. Please add \$3.00 S&H (USA/Canada). Other countries \$5.00 S&H. NYS residents please add sales tax.

To Place Credit Card Orders, Call Toll Free 1-800-654-5244 9 AM-9 PM EST 7 days a week
NY, Canada, Foreign Orders, Information, Technical Advice and Order Status call 1-716-223-1477



The CoCo vs. CoCo Controversy

The most often-received letters we get here at THE RAINBOW concern what I have decided to dub the CoCo vs. CoCo Controversy (CCC, but *not* the Civilian Conservation Corps — youngsters, read your American history textbooks).

Indeed, we get a lot of letters from people who say that we devote too much space to the CoCo 3 and not enough to the CoCo 1 and 2. Interestingly, we also get a lot of letters (something like the same number by my count) from people who say we devote too many pages to CoCo 1 and 2 and not enough to CoCo 3.

Every once in a while, one member of the editorial corps walks into my office or corners me at the Pepsi machine and allows how he or she is concerned about this letter or that. Ideas of all sorts have been advanced.

I'm not too worried, and here's why.

Back in what my children consider the dawn of recorded history (something like about the time Cro-Magnon Man was taking over from the Neanderthals, when I was young) I worked for United Press International, running the state news operation in Alabama during a particularly intense Democratic gubernatorial primary year.

There were people running from out of the woodwork all over, but the two big candidates were the incumbent, Albert Brewer, and former Gov. George Wallace — who were really slugging it out. The race had some national political implications, since Wallace (this was before the attempt on his life that left him confined to a wheelchair) was certain to run for president again if he was elected to another term as governor.

About a dozen other candidates were in the field, but Alabama has a runoff rule — the top two vote-getters go head-to-head in a second primary a few weeks later if no one gets a majority in the first election.

So, it was really a Brewer-Wallace race. Everyone knew it except, of course, some of the more obscure "other" candidates.

500 POKES, PEEKs, 'N EXECs

FOR THE TRS-80 COCO

NEVER BEFORE has this information of vital significance to a programmer been so readily available to everyone. This book will help you 'GET UNDERNEATH THE COVER' of the Color Computer and develop your own HI-QUALITY Basic and ML programs. SO WHY WAIT??

This 80-page book includes POKES, PEEKs and EXECs to:

- ★ Autostart your basic programs
- ★ Disable Color Basic/ECB/Disk Basic commands like LIST, LLIST, POKE, EXEC, CSAVE(M), DEL, EDIT, TRON, TROFF, PCLEAR, DLOAD, RENUM, PRINT USING, DIR, KILL, SAVE, LOAD, MERGE, RENAME, DSKINI, BACKUP, DSKI\$, and DSKO\$.
- ★ Disable BREAK KEY, CLEAR KEY and RESET BUTTON.
- ★ Generate a Repeat-key.
- ★ Transfer ROMPAKS to tape (For 64K only).
- ★ Set 23 different GRAPHIC/SEMIGRAPHIC modes
- ★ Merge two Basic programs.
- ★ AND MUCH MUCH MORE!!!

COMMANDS COMPATIBLE WITH 16K/32K/64K/COLOR BASIC/ECB/DISK BASIC SYSTEMS and CoCo 1, 2, & 3.

ONLY \$16.95

SUPPLEMENT to

500 POKES, PEEKs 'N EXECs

ONLY \$9.95

200 additional Pokes, Peek's 'n Execs to give you MORE PROGRAMMING POWER. Includes commands for:

- Rompak Transfer to disk
- PAINT with 65000 styles!
- Use of 40 track single/double sided drives with variable step-rates
- High-Speed Cassette Operation
- Telewriter 64[®], Edtasm+[®] and CoCo Max[®] Enhancements
- Graphics Dump (for DMP printers) & Text Screen Dump
- AND MUCH MUCH MORE!
- 500 POKES, PEEKs 'N EXECs is a prerequisite

300 POKES PEEKs 'N EXECs FOR THE COCO III

Get more POWER for your CoCo III. Includes commands for:

- 40/80 Column Screen Text Dump
- Save Text/Graphics Screens to Disk
- Command/Function Disables
- Enhancements for CoCo 3 Basic
- 128K/512K Ram Test Program
- HPRINT Character Modifier
- AND MANY MORE COMMANDS



ONLY \$19.95

"MUST" BOOKS

UNRAVELLED SERIES: These books provide a complete annotated listing of the BASIC/ECB and DISK ROMs.

EXTENDED COLOR BASIC UNRAVELLED: \$39.95

DISK BASIC UNRAVELLED: \$19.95

BOTH UNRAVELLED BOOKS: \$49.95

SUPER ECB (CoCo3) UNRAVELLED: \$24.95

ALL 3 UNRAVELLED BOOKS: \$59.95

COCO 3 SERVICE MANUAL \$39.95

COCO 2 SERVICE MANUAL: \$29.95

INSIDE OS9 LEVEL II \$39.95

RAINBOW GUIDE TO OS9 LEVEL II ON COCO 3: \$19.95

RAINBOW GUIDE TO OS9 II DISK: \$19.95

INSIDE OS9 LEVEL II DISK: \$20.00

COCO 3 SECRETS REVEALED: \$19.95

ASSEMBLY LANGUAGE PROGRAMMING*: \$18.00

ADDENDUM FOR COCO 3: \$12.00

UTILITY ROUTINES VOL 1 BOOK: \$19.95

GAMES (Disk Only) (CoCo 1, 2, & 3 except where mentioned)

WILD WEST (CoCo 3 Only) \$24.95

VEGAS SLOTS (CoCo 3 Only) \$29.95

VEGAS GAME PACK: \$24.95

FLIGHT 16: \$34.95

IN QUEST OF STAR LORD

(Animated Graphics Adventure CoCo 3): \$34.95

WHITE FIRE OF ETERNITY: \$19.95

PYRAMIX (Cubix for CoCo 3): \$24.95

P-51 MUSTANG SIMULATION: \$34.95

WORLDS OF FLIGHT: \$34.95

KUNG FU DUDE: \$24.95

APPROACH CONTROL SIMULATION: \$34.95

TREASURY PACK #1: Lunar Rover Patrol, Cubix, Declathon, Qix, Keys of Wizard, Module Man,

Pengon, Space Wrek and Roller Controller all in one package!

Only \$29.95

TREASURY PACK #2: Lancer, Ms.

Gobbler, Froggie, Madness

and Minotaur, Ice Castles,

Galagon, Devious and Syzygy all in one

package! Only \$29.95

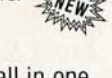
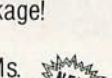
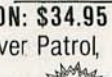
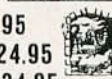

COCO GRAPHICS DESIGNER

Signs Greeting Cards Banners

The CoCo Graphics Designer allows you to create beautifully designed Greeting Cards, Signs and Banners for holidays, birthdays, parties, anniversaries and other occasions. Comes with a library of pre-drawn pictures. Also includes utilities which allow you to create your own character sets, borders and graphic pictures. Requires a TRS-80 COLOR COMPUTER I, II OR III OR TDP-100 with a MINIMUM OF 32K, ONE DISK DRIVE and a PRINTER. compatible with DISK BASIC 1.0/1.1, ADOS 1.0/1.1 AND JDOS.

Supports the following printers: DMP 100/105/110/130/430, CGP 220, EPSON RX/FX, GEMINI 10X, SG-10, NX-10 & OKIDATA **DISK \$29.95**

PICTURE DISK #1: 100 more pictures for CGD: \$14.95

FONT DISK #1: 10 extra fonts! \$19.95

FONT DISK #2: 10+ extra fonts \$19.95

CAR SIGN DESIGNER

Create distinctive bright yellow diamond shaped car signs. Includes 2 reusable clear plastic sign holders with suction cups, and 50 sheets of bright yellow fanfold paper.

Disk Only \$29.95

COLORED PAPER PACKS \$24.95

COCO MAX III (with hi-res interface): \$79.95

COCO MAX II: Disk \$77.95 Tape \$67.95

MAX PATCH An excellent software patch to run COCO MAX II on COCO III. Req. RS Hi-res Joystick Interface. No chip replacements or soldering. Disk only \$24.95

COLOR MAX 3 DELUXE: \$69.95

COLOR MAX 3: \$59.95

Telewriter-64: Best Word Processor for CoCo 1 & 2 (Cas) \$47.95 (Disk) \$57.95

TW-80: 80 Column Display & more features for TW-64. CoCo 3 Disk \$39.95

TELEFORM: Mail Merge & Form Letters for TW-64. \$19.95

Autoterm: Superb Terminal Program. Works with any modem! (Cas) \$29.95 (Disk) \$39.95

Pro Color File * Enhanced*: Multi-feature Database \$59.95 Sidewise: \$24.95

Pro-Color Dir: \$24.95

EDT/ASM 64 D: Best Disk Based Editor-Assembler for CoCo \$59.95 (Specify CoCo 1, 2 or 3)

THE SOURCE: Best Disassembler for CoCo \$34.95

THE SOURCE III: \$49.95

CBASIC: Most powerful Basic Program Compiler \$149.95 (Specify CoCo 1, 2 or 3)

DYNALCALC (COCO 1, 2 & 3): \$99.95

MJF MICROCOM SOFTWARE
P.O. Box 214
Fairport, N.Y. 14450
Phone (716) 223-1477

All orders \$50 and above shipped by UPS 2nd Day Air within Continental US at no extra charge. No CODs. We accept Visa, MC, Amex, Check or MO. Please add \$3.00 S&H (USA/Canada). Other countries \$5.00 S&H. NYS residents please add sales tax.



To Place Credit Card Orders, Call Toll Free 1-800-654-5244 9 AM - 9 PM EST 7 days a week
NY, Canada, Foreign Orders, Information, Technical Advice and Order Status call 1-716-223-1477

We did individual stories on the three or four leading candidates twice a day (once for morning and once for afternoon newspapers) and updates almost hourly for broadcast stations. We also did one roundup story that tried to incorporate all the "doings" of the day for all the candidates.

It was, I recall, about six weeks before the first primary that I started to get telephone calls. Interestingly, both the Wallace camp and the Brewer camp started calling at the same time; and both had essentially the same thing to say. That was, "We've been reading these stories in the paper here and we see that you're giving more attention to the other guy." One of the sides — I won't tell you which — even added inches of copy over a week's period and found that the opponent had five inches more "coverage" than his candidate.

I admit I was a little flustered. These calls were coming every other day or so, and I knew we were trying to be fair and balanced. Finally, I put in a call to my division news manager in Atlanta, asking for his opinion.

"Both sides are complaining," he said. "That's good. It means you're doing what you should be doing —

"Both sides are complaining," he said. "That's good. It means you're doing what you should be doing — balancing things out."

balancing things out. If one side was complaining and the other side was quiet, then I'd think that, maybe, the side that was complaining might have something to complain about."

He added, of course, that they were reading all our stories in Atlanta, too, and re-sending them for the national news report. Had they "detected bias," there was little question we would have already heard about it.

It was a good lesson for me to learn, and I've honestly applied it ever since. When people here ask me about the CCC, I tell 'em the story.

I do think we are doing a good job in providing support for all the CoCos, no matter which one you have. Yes, I look through the issues to see if there is any indication of slighting one or the other. I don't really see it.

Of course, we are dependent on your sending us submissions for programs to include in THE RAINBOW. So, if you want to enhance coverage of a specific Color Computer, send us something we can use.

No, I do not think this will still the CCC. But I hope it offers some insight.

— Lonnie Falk

One-Liner Contest Winner . . .

This short verification program is used after initializing a new disk to verify that all sectors are intact. You can also check older disks that have programs stored on them. After running this one-liner, enter the desired track you want to start reading a disk from. If a "bad" sector is encountered, an I/O Error is given along with the offending sector number.

The listing:

```
1 CLEAR400:CLS:PRINT"DISK VERIFY
1.0",,"(C) 1985 BRUCE K. BELL",
,,:PRINT"INSERT TARGET DISK.":IN
PUT"BEGIN WITH TRACK #";Q:FORT=Q
TO34:PRINT@96,"TRACK="T:FORS=1T
O18:PRINT@128,"SECTOR="S:DSKI$0,
T,S,A$,B$:NEXTS,T:PRINT:PRINT"DI
SK IS GOOD!":CLEAR200:END
```

Bruce K. Bell
Rockmart, GA

(For this winning one-liner contest entry, the author has been sent copies of both *The Third Rainbow Book of Adventures* and its companion *The Third Rainbow Adventures Tape*.)

One-Liner Contest Winner . . .

This one-liner will graph any function passed to it from within the program. Just change $Y=\sin(X)$ to any other form of $y=x$. If you don't want the graphics to vanish upon completion, add another line. Also, to use longer equations (such as $y=\sin(x)+\cos(x)+x*x/35+abs(x-10)+10$), divide the program into more lines.

The listing:

```
10 Q=6.28:PMODE4,1:PCLS:SCREEN1,
1:DRAW"BM96,0M96,192BM0,96M192,9
6BM0,96":FORX=-Q TOQ STEP(2*Q)/1
92:E=INT((X+Q)*192/(2*Q)):Y=SIN(
X):F=INT((-1*Y+Q)*192/(2*Q)):IFF
>192THENLINE-(E,192),PSET:NEXTEL
SEIFF<0THENLINE-(E,0),PSET:NEXTE
LSELINE-(E,F),PSET:NEXT
```

Paul Keller
Wayne, PA

(For this winning one-liner contest entry, the author has been sent copies of both *The Third Rainbow Book of Adventures* and its companion *The Third Rainbow Adventures Tape*.)

DISK DRIVES

Double Sided Double Density 360 K 40 Track 1/2 Ht Disk Drives for CoCo2 and 3. Buy from someone else and all you get is a disk drive. Buy from us and not only do you get a quality disk drive but also \$60 worth of disk utility software (Super Tape/Disk Transfer and Disk Tutorial) and our DISKMAX utility which allows you to use BOTH sides of our disk drives. Its like buying TWO disk drives for the price of ONE!!

Drive 0 (with J & M Controller & Cable): \$229.95 Drive 1: \$149.00

TWO 1/2 ht Drives in one case with cable & controller: \$339.95

Single Power-Supply & Case: \$59.95

Disk Drive Power Supply 'Y' Cables: \$8.95

(90 day warranty on all drives)

J&M Controller (with RSDOS): \$79.95 DISTO Super Controller: \$99.95

Mini Eprom Programmer Add-On: \$54.95 Real Time Clock & Parallel Printer Interface Add-on: \$39.95

DISTO Super Controller II: \$129.95

1 Drive Cable: \$19.95

2 Drive Cable: \$24.95

4 Drive Cable: \$39.95

(For Drives, add \$7.00 S&H in USA/Canada)

HARD DRIVES

Finally! Hard Drive Interface for Basic and OS9 from Burke & Burke!!

CoCo XT: Use up to 25-120 Meg Hard Drives. You buy WD1002-WX1 or WD1002-27X Controller, Case and drive from your PC dealer and use CoCo XT to hook the drive up to your CoCo. Includes drivers for OS9/Basic and complete documentation **\$69.95.**

HYPER I/O: Modifies RSDOS to allow use of floppy and hard drives. If you are using hard drives from Basic, you will need HYPER I/O to access the hard drives. Disk Only **\$29.95**

COCO XT ROM: Installs in hard disk controller. Boots OS9 from hard/floppy drive **\$19.95.**

CoCo XT-RTC: Same as CoCo XT with Real Time Clock/battery backup: **\$99.95.** Please note you need a 64 K CoCo or CoCo 3 and Multipak for all versions.

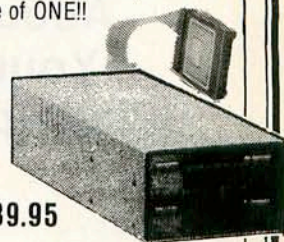

MAGNAVOX 8CM515 RGB Monitor 80

17% larger screen than standard 12" monitors.
RGB TTL, RGB Analog, Composite inputs.
Green raster display switch. Etched faceplate.
ONLY **\$294.00** Include \$12 shipping.
FREE Magnavox cable for COCO 3 with the purchase of the monitor.

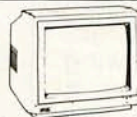

EPROM

INTRONICS EPROM PROGRAMMER: Best EPROM Programmer for the CoCo.

Lowest Price Anywhere. **\$137.95**

EPROM ERASER (Datasec): Fast erase of 24/28 pin EPROMs. **\$49.95**

EPROMS: 2764 - \$8.00, 27128 - \$9.00

Call for other EPROMs.

BOTH EPROM PROGRAMMER and ERASER: **\$179.95**

ROMPAK w/Blank PC Board 27xx Series: **\$12.95**

KEYBOARDS/ACCESSORIES

KEYBOARD EXTENSION CABLE: Our keyboard extender cable allows you to move your keyboard away from the computer and type with ease. You can use your existing keyboard with this cable or leave your present keyboard intact and use a second keyboard. A MUST for all CoCo Users. Only **\$39.95.** Cable with CoCo II keyboard: **\$49.95 COCO 3 KEYBOARD** (includes FREE FUNCTION KEYS software value \$19.95) **\$39.95** CoCo II keyboard: **\$19.95**

CHIPS, ETC.

Disk Basic Rom 1.1 (Needed for CoCo III) **\$29.95.**
68B09E Chip: **\$14.95 ECB Rom 1.1:** **\$29.95. Multi-Pak PAL Chip for CoCo3** **\$19.95 PAL Switcher:** Now you can switch between the CoCo II and CoCo III modes when using the Multi-Pak. You need the OLDER and NEW PAL chip for the 26-3024 Multipak. Only **\$39.95** With NEW PAL Chip **\$49.95**
5 1/4" DS/DD Disks: **\$0.45 each.**

COMMUNICATIONS EXTRAVAGANZA

1) AVATEX 1200e MODEM: Fully Hayes compatible 300/1200 Baud, Auto-Dial/Answer/Redial (Reg. \$129.95)

2) MODEM CABLE (Reg. \$19.95)

3) AUTOTERM TERMINAL SOFTWARE

4) FREE COMPUSERVE OFFER and Access Time

5) UPS 2nd DAY AIR Shipping.

ONLY \$149.95

(With AVATEX 1200hc instead of AVATEX 1200: \$174.95)

AVATEX 2400: **\$229.95**



CABLES/INTERFACE

RS232 Y CABLE: Hook 2 devices to the serial port. ONLY **\$18.95**

Y CABLE: Use your Disk System with CoCo Max, DS69, etc. ONLY **\$24.95**

15' PRINTER/MODEM EXTENDER CABLE: ONLY **\$16.95**

MODEM CABLE: 4 pin to DB 25: **\$19.95**

15" MULTIPAK/ROMPAK EXTENDER

CABLE: \$29.95

3-POSITION SWITCHER: \$37.95

WICO TRACK BALL: \$34.95

RS HI-RES JOYSTICK INTERFACE: \$11.99

MAGNAVOX 8505/8515/8CM643 Analog

RGB Cable: \$24.95

CM-8 RGB Analog Ext. Cable: \$19.95

SONY Monitor Cable: \$39.95

VIDEO DRIVER: For Monochrome or Color. Specify CoCo 1 or 2. **\$34.95**

VIDEO CLEAR: Reduce TV interference. **\$19.95**

SERIAL TO PARALLEL INTERFACE: With 6 switch selectable baud rates (300-9600) Comes with all cables. **\$44.95**

UPGRADES

512K UPGRADE FOR COCO III

Fast 120ns chips. Fully tested. Easy installation. No soldering. Comes with complete documentation and RAM test program on disk.



ONLY **\$99.95**



(With purchase of our 512K RAMDISK program below)

512K Upgrade without chips \$44.95

512K RAMDISK \$24.95

Have 2 superfast RAMDISKs & a print spooler.

64K Upgrade for 26-3134 A/B CoCo II: \$39.95

64K Upgrade for CoCo I's, CoCo II's with Cat #26-3026/7, 26-3134 & 26-3136: \$29.95



MICROCOM SOFTWARE

P.O. Box 214

Fairport, N.Y. 14450

Phone (716) 223-1477

All orders \$50 and above (except Disk Drives) shipped by UPS 2nd Day Air within Continental US at no extra charge. No CODs. We accept Visa, MC, Amex, Check or MO. Please add \$3.00 S&H (USA/Canada). Other countries \$5.00 S&H. NYS residents please add sales tax.

Prices are subject to change.

MasterCard

VISA



To Place Credit Card Orders, Call Toll Free 1-800-654-5244 9 AM - 9 PM EST 7 days a week

NY, Canada, Foreign Orders, Information, Technical Advice and Order Status call 1-716-223-1477

About Your Subscription

Your copy of THE RAINBOW is sent second class mail. You must notify us of a new address when you move. Notification should reach us no later than the 15th of the month prior to the month in which you change your address. Sorry, we cannot be responsible for sending another copy when you fail to notify us.

Your mailing label also shows an account number and the subscription expiration date. Please indicate this account number when renewing or corresponding with us. It will help us help you better and faster.

For Canadian and other non-U.S. subscribers, there may be a mailing address shown that is different from our editorial office address. Do not send any correspondence to that mailing address. Send it to our editorial offices at Falsoft, Inc., The Falsoft Building, P.O. Box 385, Prospect, KY 40059. This applies to everyone *except* those whose subscriptions are through our distributor in Australia.

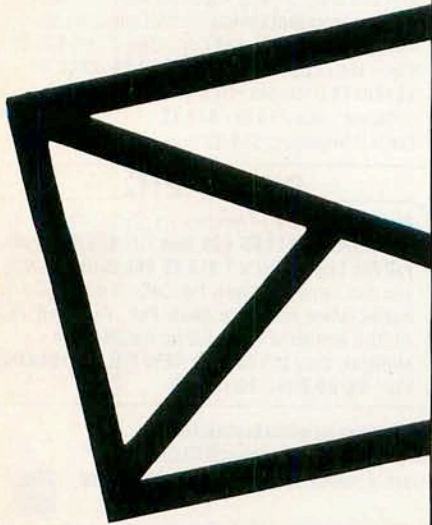

The Best Is Yet to Come

Time is a precious commodity in this pressurized, deadline-intensive world of magazine publishing. Emphasis is often placed on the next day, rather than the next issue. However, John Crawley's appointment as editorial director of Falsoft has relieved me of my duties as production coordinator, and as a result, I am free to devote even more of my attention to improving THE RAINBOW and implementing many of the excellent ideas and suggestions that have come my way since taking over as managing editor. Here is just a sampling of what you can expect in the months ahead:

- Fewer articles and programs devoted to the monthly thematic schedule, allowing more space for at least one game, graphics, music, utility and educational program in each issue
- An entertainment column, featuring CoCo-generated puzzles, contests, etc.
- More assembly and machine language programming and tutorials
- More technical information on the CoCo 3 (e.g., memory maps, bugs, patches and fixes, etc.)
- More OS-9 programs and tutorials
- Programming and uses for the Radio Shack Appliance and Light Controller
- Tutorials on drawing Hi-Res graphics pictures
- A cross-reference to the many various printers, detailing different printer codes, what they represent, and how to change them to suit different brands of printers
- A question-and-answer column to help readers with specific BASIC programming problems

Although plans are only at the preliminary stage, I'll be discussing these topics and many others with writers and programmers in the CoCo Community this month at RAINBOWfest-Chicago. Hope to see you there!

— Jutta Kapfhammer

The Best Money Can Buy . . .

HDS Floppy Drive Controller Board

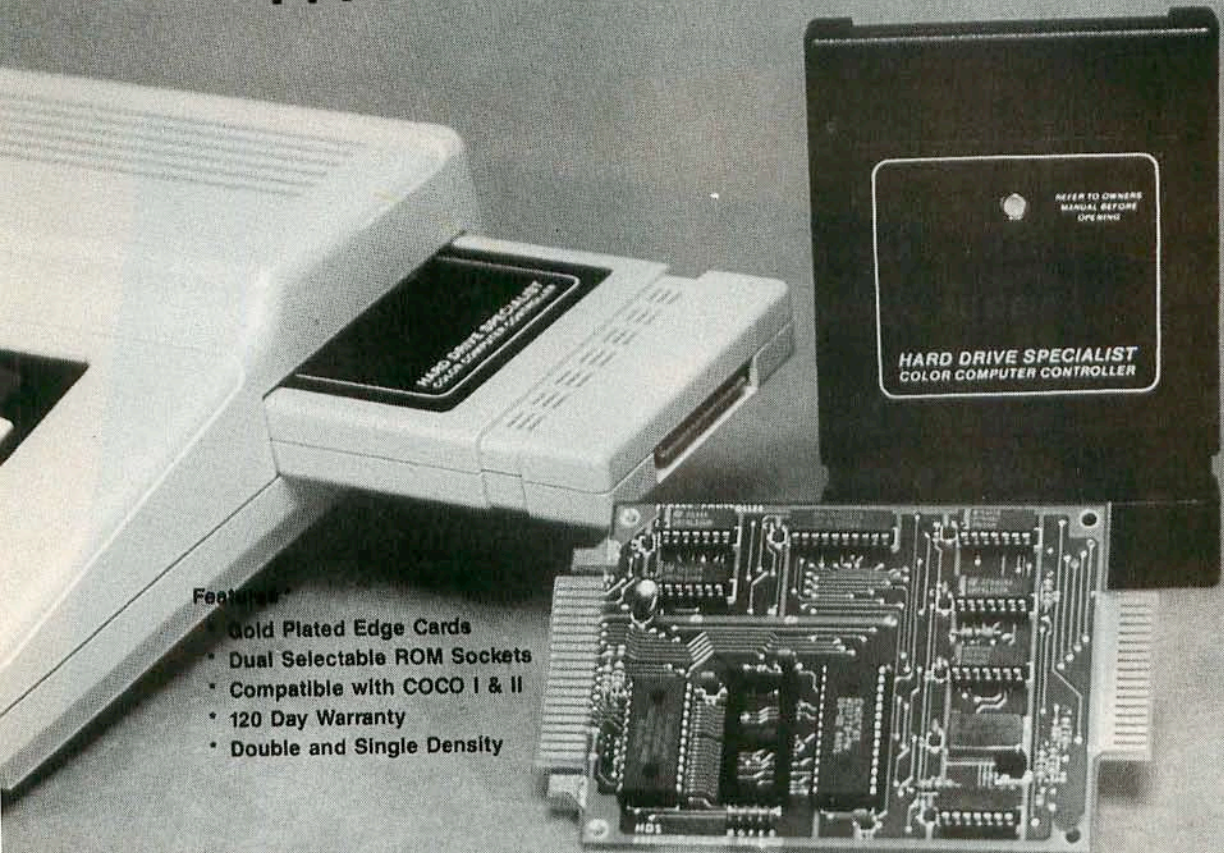

Features:

- Gold Plated Edge Cards
- Dual Selectable ROM Sockets
- Compatible with COCO I & II
- 120 Day Warranty
- Double and Single Density

Reduce your I/O errors with the Hard Drive Specialist Floppy Drive Controller for the Color Computer. Gold edge card connectors, advanced design, and the absence of potentiometers make it the best available. Our newest version controller allows the use of either (two 24 pin ROMs), or (one 24 pin and one 28 pin ROM). Using this board with the standard Radio Shack ROM gives you 100% compatibility with all Radio Shack software.

- Completed and Tested Board with Radio Shack ROM \$99.**
(Includes Case, and DOS Instructions)
- Completed and Tested Board without ROM . . . \$79.**
(Includes Case)
- Bare Board with Instruction manual \$30.**
- Parts Kit For Bare Board without ROM \$30.**
- Radio Shack ROM (current version) \$20.**
- Radio Shack ROM 1.0 \$40.**

- DOUBLE SIDED!**
- Drive 0 Complete \$199.
 - Drive 1 Complete \$129.
 - Drive 0 & 1 Dual Drive \$319.

HARD DRIVE SPECIALIST

1-713-480-6000
 Order Line 1-800-231-6671
 16208 Hickory Knoll
 Houston, Texas 77059

Ordering Information:
 Use our WATS line to place your order via Visa, MasterCard, or Wire Transfer. Or mail your payment directly to us. Any non-certified funds will be held until proper clearance is made. COD orders are accepted as well as purchase orders from government agencies. Most items are shipped off the shelf with the exception of hard drive products that are custom built. UPS ground is our standard means of shipping unless otherwise specified. Shipping costs are available upon request.

The CoCo Gallery

1st
COCO 3

Coyote
Wally Mayes

This breathtaking view from the western prairies of North America was created with CoCo Max III. Wally, a machinist by trade, lives in Hamilton, Ohio, and has many hobbies, including archery, horseshoes and leather tooling.



2nd

Rainy Day
James A. Upperman

James, of Amlin, Ohio, used CoCo 3 BASIC and a utility he is developing to create this distinct illustration.



We are taking "CoCo Gallery" to RAINBOWfest Chicago! See Page 49 for details.

SHOWCASE YOUR BEST! You are invited to nominate original work for inclusion in upcoming showings of "CoCo Gallery." Share your creations with the CoCo Community! Be sure to send a cover letter with your name, address and phone number, detailing how you created your picture (what programs you used, etc.) and how to display it. Also, please include a few facts about yourself.

Don't send us anything owned by someone else; this means no game screens, digitized images from TV programs or material that's already been submitted elsewhere. A digitized copy of a picture that appears in a book or magazine is *not* an original work.

We will award two first prizes of \$25, one for the CoCo 3 and one for the CoCo 1 and 2; one second prize of \$15 and one third prize of \$10. Honorable Mentions may also be given.

Please send your entry on either tape or disk to the CoCo Gallery, THE RAINBOW, P.O. Box 385, Prospect, KY 40059. Remember, this is a contest and your entry will not be returned.

— Angela Kapfhammer, Curator



3rd

Hyper-Flight
Keith Schuler

The CoCo 3 and CoCo Canvas, a program Keith wrote, were used to create this depiction. He is 15 years old, races model cars and enjoys the CoCo 3.

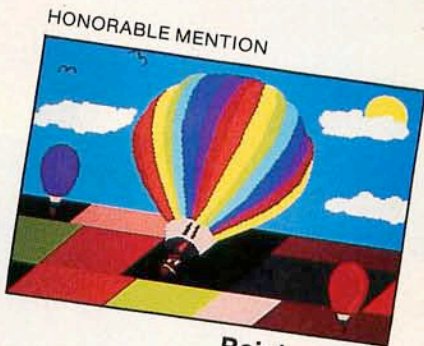

HONORABLE MENTION

Rainbwoon
Logan Ward

Logan, of Memphis, Tennessee, used Color Max 3 to develop this variegated scene.

1st

COCO 1 & 2

The Diner
Barry O'Brien

Barry, of St. Johns, Newfoundland, used CoCo Max II to illustrate this graphic. He is a self-taught programmer who enjoys sports and solving Adventure games.

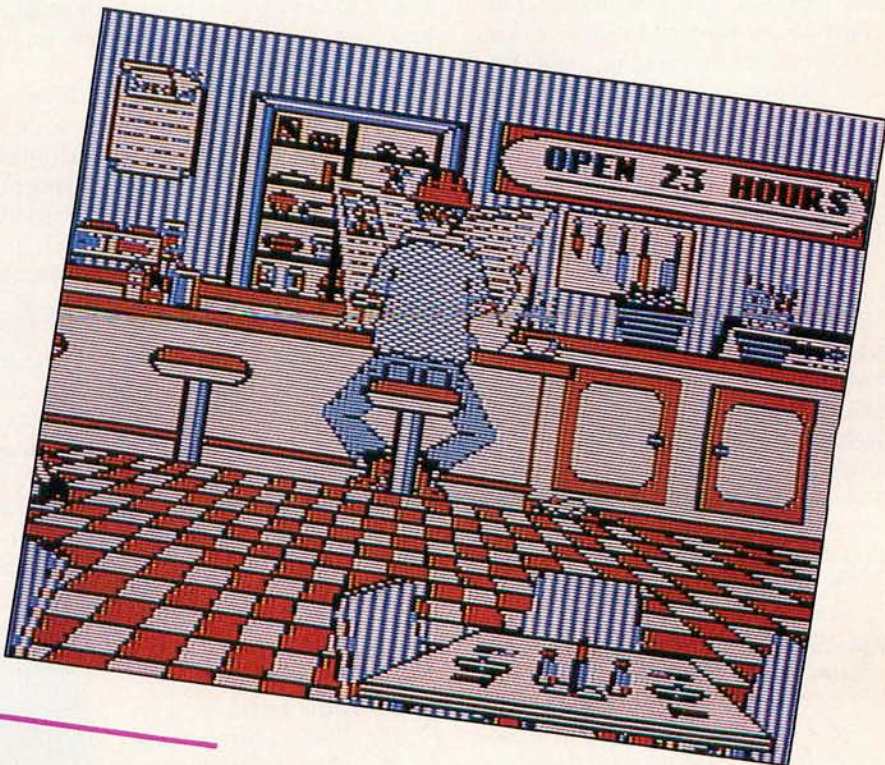



A fast-paced action game . . .

STRATA

By Michael T. Sirolly

Greetings, and welcome to the colorful courts of *Strata*! You are about to take part in a challenging and elegant game of wall-bashing, an integral part of our long and rich heritage.

First, however, it might be helpful for you to become acquainted with the deceptively simple rules to our entertaining diversion. A ball will be introduced onto the court. This ball bounces off walls and destroys colored bricks on contact. If you play our rebound variation, the ball will be deflected by the bricks; otherwise, it will proceed straight through the wall. The court is open at the bottom; your goal is to keep the ball in play by rebounding it off the bat you control.

To further complicate matters, this bat, located near the exit, decreases in size should the ball reach the court's upper wall. Also, the ball's velocity increases whenever it comes into contact with one of the upper three layers

Michael Sirolly recently laid to rest his six-year-old gray CoCo in favor of the sleeker CoCo 3. During infrequent but well-deserved breaks, he enjoys participating in drama, choral and instrumental groups.

of bricks. Every time you destroy all six rows of bricks, a new round begins with a new wall one row lower than before. There are even variations with smaller bats, faster action, and invisible bricks to make things really tough.

You receive points for each brick demolished. Your score is determined by the number of the round multiplied by the number of the brick's row (purple is Row 1, blue is Row 2, etc.). The game continues until five balls have left the court. Balls remaining, round number and score are listed on the screen's right. The right joystick controls your bat, while the red button is used to start games and release balls. Pressing the black button (on the Tandy Deluxe Joystick) or the space bar allows you to choose variations.

That's it! Extremely simple, yet extremely addicting. Now, prepare to enter the courts. Oh, and . . . good luck!

(Questions or comments regarding this program may be directed to the author at 1514 Woodhaven Drive, Hummelstown, PA 17036. Please enclose an SASE when requesting a reply.) □

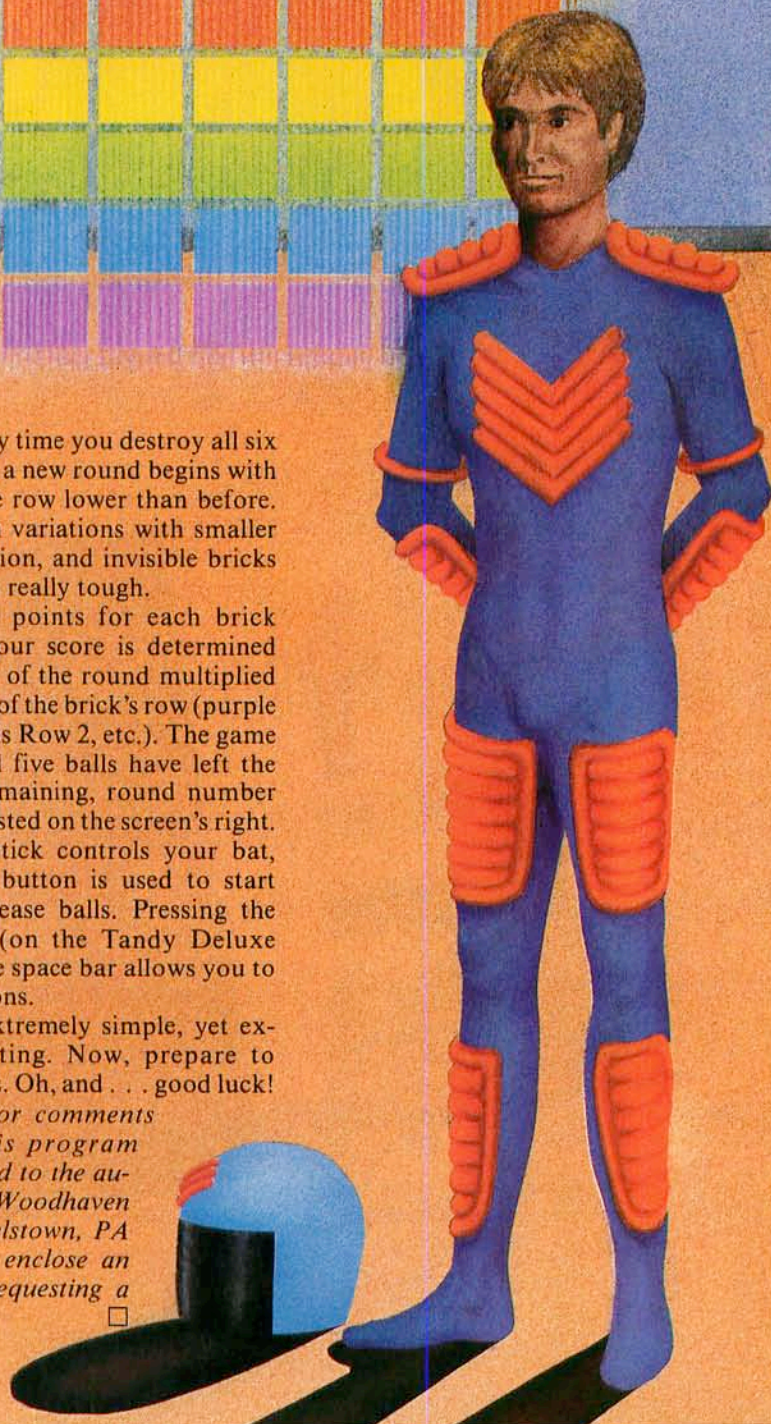
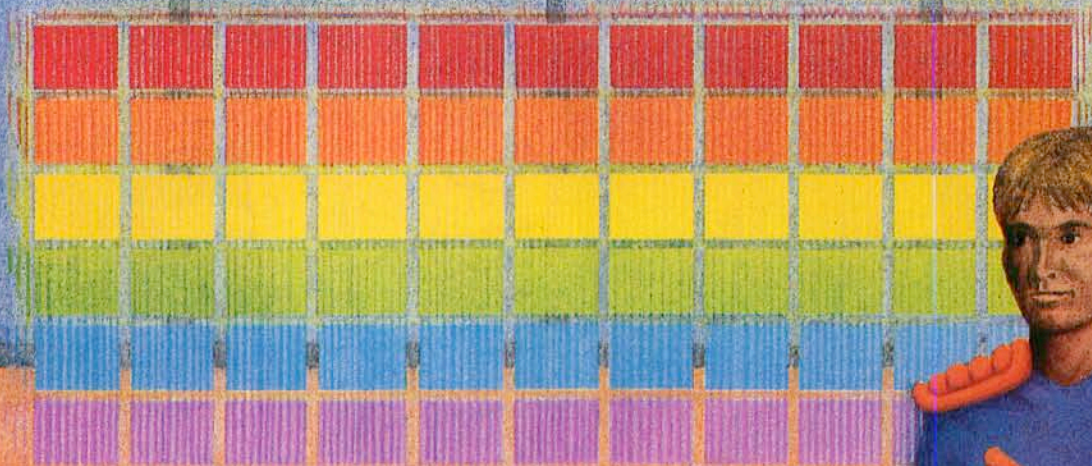

The Amazing A-BUS

NEW

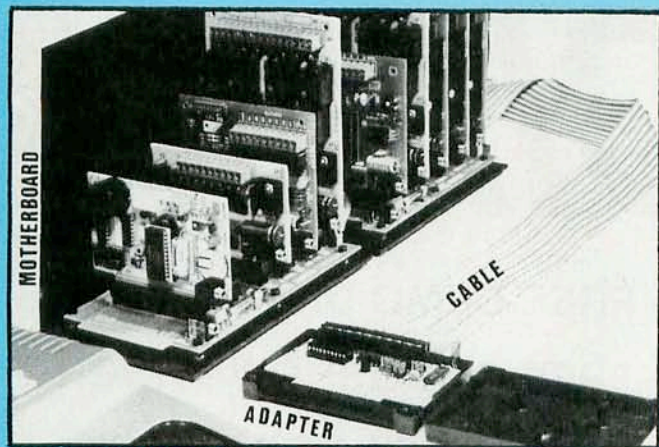

An A-BUS system with two Motherboards
A-BUS adapter in foreground

The A-BUS system works with the original CoCo,
the CoCo 2 and the CoCo 3.

Plug into the future

With the A-BUS you can plug your PC (IBM, Apple, TRS-80) into a future of exciting new applications in the fields of control, monitoring, automation, sensing, robotics, etc.

Alpha's modular A-BUS offers a proven method to build your "custom" system today. Tomorrow, when you are ready to take another step, you will be able to add more functions. This is ideal for first time experimenting and teaching.

A-BUS control can be entirely done in simple BASIC or Pascal, and no knowledge of electronics is required!

An A-BUS system consists of the A-BUS adapter plugged into your computer and a cable to connect the Adapter to 1 or 2 A-BUS cards. The same cable will also fit an A-BUS Motherboard for expansion up to 25 cards in any combination.

The A-BUS is backed by Alpha's continuing support (our 11th year, 50000 customers in over 60 countries).

The complete set of A-BUS User's Manuals is available for \$10.

About the A-BUS system:

- All the A-BUS cards are very easy to use with any language that can read or write to a Port or Memory. In BASIC, use INP and OUT (or PEEK and POKE with Apples and Tandy Color Computers)
- They are all compatible with each other. You can mix and match up to 25 cards to fit your application. Card addresses are easily set with jumpers.
- A-BUS cards are shipped with power supplies (except PD-123) and detailed manuals (including schematics and programming examples).

Relay Card

RE-140: \$129

Includes eight industrial relays. (3 amp contacts, SPST) individually controlled and latched. 8 LED's show status. Easy to use (OUT or POKE in BASIC). Card address is jumper selectable.

Reed Relay Card

RE-156: \$99

Same features as above, but uses 8 Reed Relays to switch low level signals (20mA max). Use as a channel selector, solid state relay driver, etc.

Analog Input Card

AD-142: \$129

Eight analog inputs. 0 to +5V range can be expanded to 100V by adding a resistor. 8 bit resolution (20mV). Conversion time 120us. Perfect to measure voltage, temperature, light levels, pressure, etc. Very easy to use.

12 Bit A/D Converter

AN-146: \$139

This analog to digital converter is accurate to .025%. Input range is -4V to +4V. Resolution: 1 millivolt. The on board amplifier boosts signals up to 50 times to read microvolts. Conversion time is 130ms. Ideal for thermocouple, strain gauge, etc. 1 channel. (Expand to 8 channels using the RE-156 card).

Digital Input Card

IN-141: \$59

The eight inputs are optically isolated, so it's safe and easy to connect any "on/off" devices, such as switches, thermostats, alarm loops, etc. to your computer. To read the eight inputs, simply use BASIC INP (or PEEK).

24 Line TTL I/O

DG-148: \$65

Connect 24 input or output signals (switches or any TTL device) to your computer. The card can be set for: input, latched output, strobed output, strobed input, and/or bidirectional strobed I/O. Uses the 8255A chip.

Clock with Alarm

CL-144: \$89

Powerful clock/calendar with: battery backup for Time, Date and Alarm setting (time and date); built in alarm relay, led and buzzer; timing to 1/100 second. Easy to use decimal format. Lithium battery included.

Touch Tone® Decoder

PH-145: \$79

Each tone is converted into a number which is stored on the board. Simply read the number with INP or POKE. Use for remote control projects, etc.

A-BUS Prototyping Card

PR-152: \$15

3 1/2 by 4 1/2 in. with power and ground bus. Fits up to 10 I.C.s

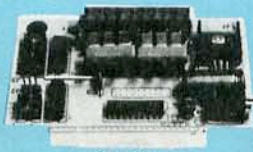

ST-143

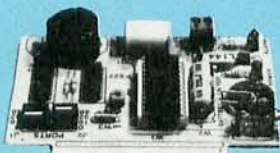

CL-144

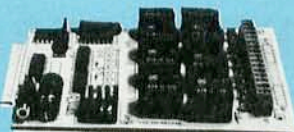

RE-140



IN-141

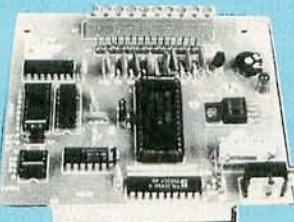

AD-142

Smart Stepper Controller SC-149: \$299

World's finest stepper controller. On board microprocessor controls 4 motors simultaneously. Incredibly, it accepts plain English commands like "Move arm 10.2 inches left". Many complex sequences can be defined as "macros" and stored in the on board memory. For each axis, you can control: coordinate (relative or absolute), ramping, speed, step type (half, full, wave), scale factor, units, holding power, etc. Many inputs: 8 limit & "wait until" switches, panic button, etc. On the fly reporting of position, speed, etc. On board drivers (350mA) for small steppers (MO-103). Send for SC-149 flyer.

Remote Control Keypad Option RC-121: \$49

To control the 4 motors directly, and "teach" sequences of motions.

Power Driver Board Option PD-123: \$89

Boost controller drive to 5 amps per phase. For two motors (eight drivers).

Breakout Board Option BB-122: \$19

For easy connection of 2 motors. 3 ft. cable ends with screw terminal board.

Stepper Motor Driver ST-143: \$79

Stepper motors are the ultimate in motion control. The special package (below) includes everything you need to get familiar with them. Each card drives two stepper motors (12V, bidirectional, 4 phase, 350mA per phase).

Special Package: 2 motors (MO-103) + ST-143: PA-181: \$99

Stepper Motors MO-103: \$15 or 4 for \$39

Pancake type, 2 1/4" dia. 1/4" shaft, 7.5"/step. 4 phase bidirectional, 300 step/sec. 12V, 36 ohm, bipolar, 5 oz-in torque, same as Airpax K82701-P2.

Current Developments

Intelligent Voice Synthesizer, 14 Bit Analog to Digital converter, 4 Channel Digital to Analog converter, Counter Timer, Voice Recognition.

A-BUS Adapters for:

IBM PC, XT, AT and compatibles. Uses one short slot.	AR-133...\$69
Tandy 1000, 1000 EX & SX, 1200, 3000. Uses one short slot.	AR-133...\$69
Apple II, II+, IIe. Uses any slot.	AR-134...\$49
TRS-80 Model 102, 200. Plugs into 40 pin "system bus"	AR-136...\$69
Model 100. Uses 40 pin socket. (Socket is duplicated on adapter).	AR-135...\$69
TRS-80 Mod 3.4.4 D. Fits 50 pin bus (With hard disk use Y-cable).	AR-132...\$49
TRS-80 Model 4P. Includes extra cable. (50 pin bus is recessed).	AR-137...\$62
TRS-80 Model I. Plugs into 40 pin I/O bus on KB or E/I.	AR-131...\$39
Color Computers (Tandy). Fits ROM slot. Multipak. or Y-cable.	AR-138...\$49

A-BUS Cable (3 ft, 50 cond.) CA-163: \$24

Connects the A-BUS adapter to one A-BUS card or to first Motherboard.

Special cable for two A-BUS cards: CA-162: \$34

A-BUS Motherboard

MB-120: \$99

Each Motherboard holds five A-BUS cards. A sixth connector allows a second Motherboard to be added to the first (with connecting cable CA-161: \$12). Up to five Motherboards can be joined this way to a single A-BUS adapter. Sturdy aluminum frame and card guides included.

• The A-BUS is not a replacement for the Multi-pak

Add \$3.00 per order for shipping.
Visa, MC, checks, M.O. welcome.
CT & NY residents add sales tax.
C.O.D. add \$3.00 extra.
Canada: shipping is \$5
Overseas add 10%



ALPHA Products

242-W West Avenue, Darien, CT 06820

Technical info: (203) 656-1806
Orders only 800 221-0916
Except in CT
Connecticut orders: (203) 348-9436
All lines open weekdays 9 to 5 Eastern time

SPECIAL

WITH YOUR
COCO MAX III ORDER:

- FREE DEMO DISK
- FREE COCOSHOW PROGRAM
- FREE EXTRA FONTS DISK



CoCo Max™ III



must be the most enjoyable, useful,
and awesome program you've ever
seen or your money back. Instantly,
no questions asked.

CALL NOW TOLL FREE 1-800 221 Mon-Fri
9 to 5 EST AND LET THE FUN BEGIN

A FEW QUOTES :

An outstanding program that almost turns your CoCo into a replica of the Macintosh. Terrific hi-res color, very easy to learn and use.
- *Family Computing*

There is absolutely nothing else on the Color Computer that is comparable to CoCo Max's power and ease of use. The most enjoyable time with a computer I ever had.
- *Computerware Review*

In Everyone's book, CoCo Max is rated again and again as the most incredible product ever marketed for the CoCo.
- *CoCo America Club*

I never expected to see anything like it on my CoCo screen. There isn't a single command to remember. Even a person who has no drawing ability like myself can create a presentable picture. I've spent hours just doodling enjoying all the things from silly to the serious. Fascinating experience. Buy it, you won't be sorry.
- *6809 Express*

Note: There is only one CoCo Max III. Do not confuse **COLORWARE**'s CoCo Max with similar sounding imitations.

INTRODUCING THE NEXT GENERATION:

CoCo Max™ III*

More Resolution

More Power

More Color

Built-in Animation

More Speed

More Type Styles

More Tools

Amazing Color Sequencing

"The best program ever written for the Color Computer"

That's how thousands of enthusiastic users rated the CoCo Max II drawing program. With CoCo Max III we are ready to amaze them again. Instead of "patching" CoCo Max II, we rewrote it from scratch to take advantage of the CoCo Max III hardware. The results will knock your socks off! Below is a brief list of some of the *new* features, but some, such as **animation**, **color sequencing**, or the **slide show**, have to be seen. Send for the Demo Disk, and see for yourself.

Everybody's favorite drawing package features:

- A 50% larger editing window. - Zoom area 400% larger. - New drawing tools: **rays**, **3D cubes**, **arcs**,...
- New editing tools: shadow, text size,...
- Rotate by 1.5° steps - Select any 16 of the 64 possible colors (all 64 colors displayed at once!)
- Powerful **color mix**: additive, subtractive, overlay,...
- Full **color editing** of patterns and color changing patterns. - Incredible **special effects** with **color cycling** up to 8 colors with variable speed. - **Animation** adds the dimension of motion to your image. (Must be seen.)
- Sophisticated data compression saves up to 70% of disk space when saving pictures.

In addition, there are dozens of enhancements to the multitude of features that made CoCo Max II a best seller.

More about CoCo Max III

- CoCo Max III is not an upgrade of CoCo Max II. It is entirely rewritten to take advantage of the new CoCo 3 hardware (More memory, resolution, colors, speed,...)
- The new CoCo Max III **Hi-Res Interface** and the CoCo Max II **Hi-Res Pack** are *not* interchangeable.
- The new interface plugs into the joystick connector.
- The CoCo Max III disk is not copy protected.
- CoCo Max III only works with the CoCo 3.
- A Y-Cable or Multi-pak is not necessary.
- Colors are printed in five shades of gray.
- CoCo Max III can read CoCo Max II pictures.

Note: CoCo Max II (for the CoCo 2) is still available on disk (\$79.95). CoCo Max I is still available on tape (\$69.95). For details, refer to our double page ad in any *Rainbow* from January '86 to July '87

Toll Free operators are for orders only. If you need precise answers, call the **tech line**. (Detailed CoCo Max specs are included with the Demo Disk.)

Add \$3.00 per order for shipping. Visa, MC, checks, M.O. welcome. CT residents add sales tax. C.O.D. add \$3.00 extra. Canada: shipping is \$5. Overseas add 10%.

Technical info: (203) 656-1806
Orders only Except in CT 800 221-0916
Connecticut orders: (203) 348-9436
All lines open weekdays 9 to 5 Eastern time

* Beware of inferior imitations that **DO NOT** include a Hi-Res Interface or charge extra for each utility.

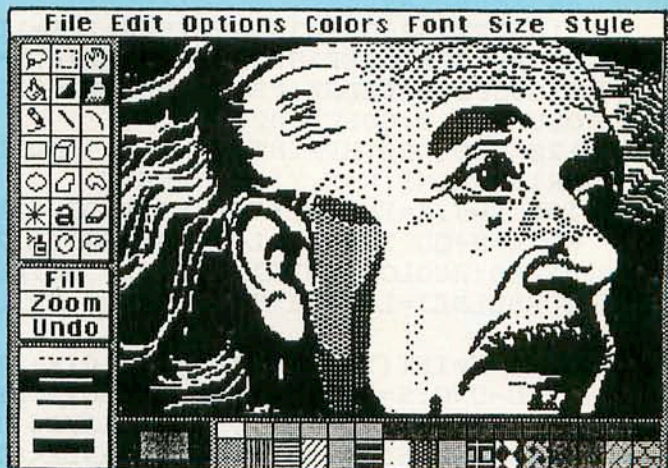

Imagine this picture in sixteen colors!

Guaranteed Satisfaction
Use CoCo Max for a full month.
If you are not delighted with it,
we will refund every penny.

System Requirements:

Any CoCo 3 disk system with a Joystick or a Mouse.

We apologize to tape users, CoCo Max III needs the flexibility of a disk.

The CoCo Max III system includes: • The special Hi-Res interface (for your mouse or joystick) • The CoCo Max III disk • Many utilities: (To convert Max II pictures, Max colors, etc.) • A detailed User's Manual. Complete system; nothing else to buy. **CoCo Max III: \$79.95***

WITH COUPON ONLY

FREE DEMO DISK

Name _____
Street _____
City _____
State Zip _____

Printer used: _____

Please include \$2 to help defray Processing and Shipping costs. (Check, Money Order, etc. Sorry, no COD or Credit Cards). Coupon (or copy) must be mailed to:

COLORWARE

COLORWARE
242-W West Avenue
Darien, CT 06820

A division of Sigma Industries, Inc.

✓	754090	1023093
	950072	20000107
	10010184	50000102
	1003674	50050234
	10110146	END24

The listing: STRATA

```

10 CLEAR900:GOSUB10000:GOSUB9000
99 GOSUB100:IFE=1GOTO10010ELSE99
100 FORM=0TOD:V=X:W=Y:X=X+T:Y=Y+
U:IFX<2ORX>=30THENT=-T:X=X+T+T:I
FN THENPLAY"C"
110 IFY>=21ORY<3GOSUB7500:IFE=1T
HENRETURNELSEELSEIFHPOINT(X*8,Y*
8)GOSUB7000ELSEIFSG=ANDW-F>=13G
OSUB10110:GOSUB8000
120 HCOLOR0:HPRINT(V,W),"%":HCOL
OR1:HPRINT(N*X,Y),"%":NEXT
190 L=J:J=FNJ(0):IFL<>J ANDJ>=2A
NDJ<=H+QD THENHCOLOR0:HPRINT(L,2
2),B$:HCOLOR1:HPRINT(J,22),B$:RE
TURNELSEJ=L:HPRINT(J,22),B$:RETU
RN
7000 K=INT(Y-F):POKE65466,C(K-3)
*I:U=U*Q:S=S+(11-K)*R:HCOLOR0:HP
RINT(INT(X/2)*2,Y),"#$":PLAYC$(1
2-K):POKE65466,0:IFD=BS-1ANDK<8T
HEND=BS:RETURNELSERETURN
7500 IFY>=24GOSUB9000:RETURNELSE
IFY<3THENIFH=0THENH=(PD-24+2)/2:
B$=SP$:HCOLOR0:HPRINT(J,22),LP$E
LSEELSEIFY<23ANDU>0ANDX>=J ANDX<
J-H+PD-22THENJ=J+.1:IFY=22THENY=
21:T=SGN(X):U=.5ELSEIFRND(3)=1TH
ENPLAY"C":ONRND(3)GOTO7510,7530,
7540ELSEELSERETURN
7501 J=J+.1:U=-U:PLAY"C":RETURN
7510 T=SGN(T)/2:U=-1:RETURN
7530 T=SGN(T):U=-1:RETURN
7540 T=-SGN(T):U=-ABS(U):RETURN
8000 O=K:K=Z:Z=O:FORA=2TO7:HCOL
OR1*10+A-I*A:HPRINT(2,F+A+3),"##$
#$#$#$#$#$#$#$#$#$#$#$":NEXT:
RETURN
9000 J=J+.1:H=0:D=BS-1:N=0:HCOL
OR0:HPRINT(V,W),"%":HCOLOR0:HPRIN
T(J,22),B$:J=2:B$=LP$:FORZ=1TO10
:GOSUB190:PLAY"O2CO4":NEXT:BL=BL
-1:IFP GOSUB9500:IFBL=-1THEN5000
0
9010 IFBUTTON(0)=0ANDP GOSUB190:
GOTO9010ELSEV=10:W=23:X=2+RND(5)
:Y=11+F:HCOLOR0:HPRINT(33+BL,9),
"%":HCOLOR1:HPRINT(X,Y),"%":XX=X
:YY=Y
9020 IFBUTTON(0)ANDP GOSUB190:GO
TO9020ELSEN=1:T=1:U=1:X=XX:Y=YY:

```

```

PLAY"V31":RETURN
9500 S=S-INT(S/1000000)*1000000:
PLAY"O5":HCOLOR1:VZ=V:WZ=W:OT=T:
OU=U:OD=D:NZ=N:XZ=X:YZ=Y:D=1:N=0
:LS=LEN(STR$(S)):FORYY=1TO0STEP-
1:FORXX=0TO9:HCOLORYY+RND(6)*YY:
PLAYSTR$(XX+1):HPRINT(40-LS,5),S
TRING$(LS-1,48+XX):HCOLOR-YY+1:H
PRINT(39-LS,5),S
9510 HCOLOR1:GOSUB190:NEXTXX,YY:
V=VZ:W=WZ:T=OT:U=OU:N=NZ:X=XZ:Y=
YZ:D=OD:PLAY"O4":RETURN
10000 ON BRK GOTO25000:DIMC$(12)
:POKE65497,0:WIDTH40:PALETTE0,0:
PALETTE11,63:CLS1:Q=-1:RP=1:LOCA
TE3,10:ATTR3,0:PRINT"Is this an
RGB color monitor? (Y/N)":ATTR2,
0:PRINT:DATA0,63,36,52,54,18,25,
45,18,56,0,0,63,24,38,52,33,29,2
6,33,32,0
10001 A$=INKEY$:IFA$="N"ORA$="n"
THENC$=16:GOSUB10006:GOSUB10007E
LSEIFA$="Y"THENC$=7:GOSUB10007:G
OSUB10006ELSE10001
10005 BS=1:QD=26:PD=QD:LP$="###$
":SP$="#$":PLAY"T255O5B":WIDTH40
:ATTR0,0:FORX=0TO31:READC:POKEX+
61621,C:NEXT:GOTO10010:DATA255,2
55,255,255,255,255,255,0,254,254
,254,254,254,254,0,0,0,28,62
,62,62,28,0,124,130,154,162,154,
130,124,0
10006 FORX=0TO10:READC:NEXT:FORX
=1TO12:C$(X)=STR$(X):NEXT:RETURN
10007 FORX=0TO10:READC(X):PALETT
EX,C(X):NEXT:RETURN
10010 ONBRK GOTO20000:E=0:GOSUB1
1000:FORX=2TO7:PALETTEEX,0:NEXT:T
I$="C2R6EU4HL6HU4ER6C3BR2R8L4D12
BR6C4U12R7FD4GL7R6F2D4BR2C5U11ER
6FD5NL8D6BR6C6C6U12L4R8BR3C7R6FD
5NL8D6BL8U11E":FORX=0TO2:FORY=0T
O2:HDRAW"S20BM"+STR$(23+X)+", "+S
TR$(100+Y)+TI$:NEXTX,Y
10015 PLAY"T255L255O4":FORX=2TO7
:PALETTEEX,C(X):SOUNDX*10,2:NEXT:
ST$="by Michael Sirollly":FORX=22
TO15STEP-1:HCOLOR0:HPRINT(11,X+1
),ST$:HCOLOR1:HPRINT(11,X),ST$:P
LAY"V20;"+STR$(25-X):NEXT
10020 OC=15:C=11:FORX=0TO39:PALE
TTEC,C(4):HCOLORC:HPRINT(39-X,23
),"%":HPRINT(X,0),"%":C=C+1:IFC=
16THENC=11:NEXTELSENEXT
10025 HCOLOR9:HPRINT(6,18),"vers
ion 1.0 & June, 1987":PLAY"V
31O4":FORX=1TO6:PLAY"CV-V-V-V-V-
":NEXT:PLAY"V31":T=100
10030 T=T-1:GOSUB11100:IFBUTTON(
0)GOTO10130ELSEIFBUTTON(1)ORINKE

```



```

Y$=" "GOTO1020ELSEIFT THEN10030
10035 IFHI$(1)<>"THENT=100:HCOL
OR15:Z$=STRING$(40,"%"):HPRINT(0
,0),Z$:HPRINT(0,23),Z$:FORX=1TO1
2:PALETTE,X:NEXT:HCOLOR10:HPRIN
T(15,5),"TOP SCORES":HDRAW"S4C11
BM116,43L39GD96FR166EU96HL40"ELS
E10050
10036 PALETTE11,C(6):PALETTE12,C
(1):HCOLOR12:FORX=1TO10:IFHI$(X)
<>"THENT$=RIGHT$(STR$(X),2)+".
"+HI$(X):HPRINT(10,6+X),ST$:NEX
TELSENEXT
10040 PALETTE10,RND(63):T=T-1:IF
BUTTON(0)GOTO10130ELSEIFBUTTON(1
)ORINKEY$=" "GOTO1020ELSEIFT TH
ENIF(T/10)-INT(T/10)>.4THENPALET
TE15,C(4):GOTO10040ELSEPALETTE15
,CS:GOTO10040
10050 S=0:R=1:F=0:GOSUB11200:HCO
LOR1:HPRINT(39-LEN(STR$(SP)),5),
SP:HPRINT(36-LEN(STR$(RP))/2,13)
,RP:P=0:DEF FNJ(K)=X+T:V=3:W=3:H
COLOR1,0:G=-1:BL=5:GOSUB9000:TI=
200
10055 S$="GAME OVER
PRESS BUTTON TO START
SPACE- OPTIONS":FORZ=0TO8:HCO
LORZ/3+2:HPRINT(32,15+Z),MID$(S
$,1+Z*8,8):NEXT
10060 GOSUB100:IFBUTTON(0)GOTO10
130ELSEIFBUTTON(1)ORINKEY$=" "TH
EN1020ELSEIFS<60+Q*40GOTO10060E
LSE10010
10100 R=1:F=0:GOSUB11200:T=-1:S=
0:P=1:FORX=1TO5:HPRINT(32+X,9),"
%":PLAY"O5V31GV26GV21GV16GV11GV6
GV1GV31":NEXT:V=3:W=3:BL=5:R=0:D
EF FNJ(A)=INT(JOYSTK(0)/((PD-H)/
10)+2)
10110 HCOLOR0:HPRINT(34,13),"###
#":R=R+1:HCOLOR1:HPRINT(36-LEN(S
TR$(R))/2,13),R:G=294*R+S:F=R-1:

```

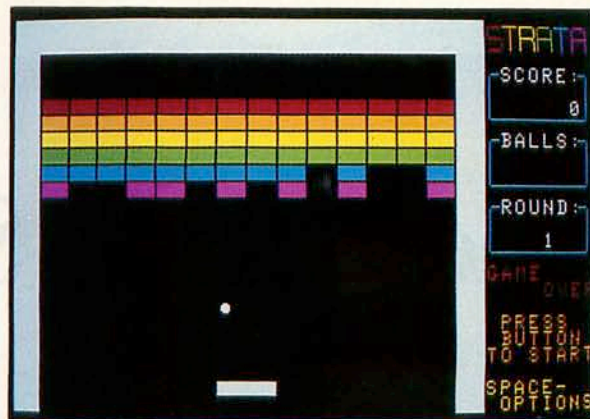

```

IFF>8THENF=8
10120 RETURN
10130 GOSUB10100:GOSUB9000:GOTO9
9
10200 HCLS0:FORX=0TO10:PALETTE,X
C(X):NEXT:HCOLOR1:HPRINT(16,7),"
OPTIONS":HDRAW"S4C6BM124,59L15G
D62FR100EU62HL15"
10210 L=9:C1$="YES":C2$="NO":OP$
="REBOUND?":R$(0)="REBOUND.":R$(
1)="DEMOLISH.":GOSUB10250:Q=R:OP
$="VISIBLE?":R$(0)="VISIBLE.":R$(
1)="INVISIBLE.":GOSUB10250:I=(R
+1)/2

```

Mouse Tales By Logan Ward



THE POWER STONES OF ARD

THE QUEST FOR THE SPIRIT STONE



You're tired, you're hungry, not to mention you're badly injured. No one in town seems to have time to talk to you. Your magic sword has stopped glowing, the room is dark, you're out of spells, you can't get your wand to work, you won't swear to it but you may be lost, you have no idea what that last puzzle meant, and you hear something large moving just beyond the only door. The old sage warned you there would be days like this!

"QUEST FOR THE SPIRIT STONE" is an Adventure that will keep you playing for hours. It features single keystroke commands, 16 color graphics, 100% Hi-Res graphics screens, full game save, extensive playing area, level advancement, and the disk is not copy-protected. You choose your character's name, race, sex, and ability scores. The use of arrow keys simplify movement. This one is easy to play but a challenge to complete!

ONLY \$18.00 AND WE PAY SHIPPING!

North Carolina residents add 5% sales tax
COLOR COMPUTER 3 AND ONE DISK DRIVE REQUIRED

Send check or money order to:
or call:
(919) 582-5121

THREE C'S
PROJECTS
P.O. Box 1323
Hamlet, NC 28345

Come to Radio Shack for the Very



Thexder/TM Sierra On-Line, Shanghai and Microscopic Mission/TM Activision, Flight Simulator/TM subLOGIC, Sub Battle Simulator/TM EPYX, Where in the World is Carmen Sandiego?/TM Broderbund.

Tandy Computers:
Because there is
no better value.[™]

Best in Color Computer Software

What a selection!

At Radio Shack, we're dedicated to making sure that you never run out of ways to use and enjoy your Color Computer. We've got a terrific line of software—here's just a sample.

Games for the whole family

Let your Color Computer open the door to fun and adventure. Radio Shack has a dazzling selection of various types of popular and challenging games.

You can learn the basics of flying in *Flight Simulator II*, or play a game of cat-and-mouse with enemy subs in *Sub Battle Simulator*.

Our exciting Program Pak™ games let you explore a secret cave in *Downland*. Battle enemy robots in *Theuder*. Uncover hidden treasure in *Springster*. Play Mahjong in *Shanghai* . . . or play ball with *Color Baseball*.

Make learning fun

One of the greatest potential uses of your Color Computer is giving your child a head start in education. We've got programs that cover a variety of disciplines, and are fun, too!

Children will learn computer skills with *BASIC-09 Tour Guide*. *The Color Computer Artist* may bring out the Van Gogh in your child! Geography is made easy in *Where in the World is Carmen Sandiego?* And *Microscopic Mission* lets your child explore the human body—from the inside out.

Boost home productivity

No matter what your personal needs, we have programs that will put your Color Computer to work when you need it most.

Spectaculator is a great spreadsheet and forecaster. Create a house-

hold budget with *Personal Finance*. Word processing is easy with *Color SCRIPSIT® II*. And you'll have no more tiresome piles of paper with *Color File II*.

DeskMate 3™ features seven popular applications from Paint to Text—all on one diskette. *Phantomgraph* helps you create complex charts and graphs. And for the writer of the house, *Home Publisher* creates newsletters and flyers with ease.

Programming tools

You'll find your Color Computer is much more than a game computer. Our programming software lets you fully enjoy the benefits of owning a home computer, and designing and running your own programs.

OS-9 Level Two will let you program your own information system. You can create and execute personal programs in Assembly language with *Editor/Assembler Development System*. And *Multi-View* is a user-friendly graphics interface for OS-9 Level Two software programs.

Come in today!

Need more suggestions? Just clip out the coupon and send for a 1988 Computer Catalog & Software Reference Guide. Radio Shack is your one-stop software center.

Send me a 1988 computer catalog.

Mail To: Radio Shack, Dept. 88-A-707
300 One Tandy Center, Fort Worth, TX 76102

Name _____

Address _____

City _____

State _____ ZIP _____

Phone _____

Radio Shack®
The Technology Store™
A DIVISION OF TANDY CORPORATION

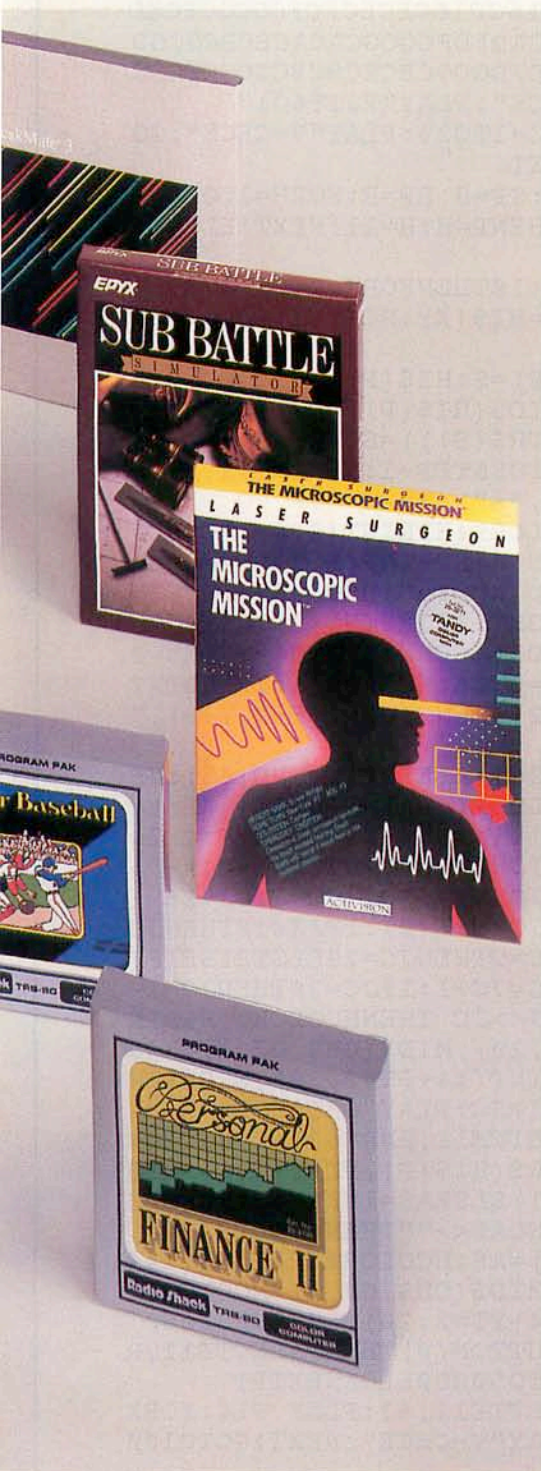

```

10215 OP$="SPEED?":C1$="SLOW":C2
$="FAST":R$(0)="SLOW SPEED.":R$(
1)="FAST SPEED.":GOSUB10250:BS=(
R+1)/2+1:OP$="PADDLES?":C1$="LAR
GE":C2$="SMALL":A$=" SIZE.":R$(0
)=C1$+A$:R$(1)=C2$+A$:GOSUB10250
10220 HCOLOR1:HPRINT(14,14),"PRE
SS BUTTON":IFR=1THENLP$="#$":SP$
="$":QD=28:PD=24ELSELP$="###$":S
P$="#$":QD=26:PD=QD
10230 IFBUTTON(0)ORBUTTON(1)ORIN
KEY$<>"THENHCLS0:GOTO10050ELSE1
0230
10250 HCOLOR1:HPRINT(15,L),OP$:P
ALETTE2,C(9):PALETTE3,C(9):HCOLO
R2:HPRINT(14,14),C1$:HCOLOR3:HPR
INT(26-LEN(C2$),14),C2$
10260 Z=RND(63):IFJOYSTK(0)<33TH
ENR=-1:P1=Z:P2=C(9)ELSER=1:P2=Z:
P1=C(9)
10270 PALETTE2,P1:PALETTE3,P2:IF
BUTTON(0)<>1THEN10260ELSEPLAY"T2
5505B"
10280 IFBUTTON(0)THEN10280
10290 HCOLOR0:HPRINT(15,L),OP$:H
PRINT(14,14),C1$:HPRINT(26-LEN(C
2$),14),C2$:HCOLOR9:HPRINT(15,L)
,R$(R+1)/2):L=L+1:PALETTE2,C(2)
:PALETTE3,C(3):RETURN
11000 FORX=0TO15:PALETTE,X:NEXT
:HSCREEN2:FORX=0TO10:PALETTE,X(C
X):NEXT:RETURN
11100 PALETTE,C(4):PALETTEOC,CS
:OC=C:C=C+1:IFC=16THENC=11:RETUR
NELSERETURN
11200 GOSUB11000:FORX=1TO10:PALE
TTEX,0:NEXT:HDRAW"S4BM0,0C1D191R
14U174R226D174R15U191":HPAINT(1,
1),1:HDRAW"BM258,15"+TI$:GOSUB80
00
11210 S$="L4GD20FR54EU20HL4BL46B
D32":HDRAW"C6BM263,27"+S$+S$+S$:
HCOLOR1:HPRINT(33,7),"BALLS":HP
RINT(33,11),"ROUND":HPRINT(33,3
),"SCORE":FORX=1TO10:PALETTE,X
(X):NEXT:RETURN
20000 HCOLOR6,0:HSCREEN2:FORX=0T
O10:PALETTE,X(C(X)):NEXT:PALETTE13
,C(6):HDRAW"S4C13BM117,83L4GD22F
R92EU22HL4":HCOLOR1:HPRINT(15,10
),"QUIT GAME?":HCOLOR11:HPRINT(1
5,12),"YES":HCOLOR12:HPRINT(23,1
2),"NO"
20010 A=RND(63):IFJOYSTK(0)<33TH
ENC1=A:C2=C(9)ELSEC1=C(9):C2=A
20020 PALETTE11,C1:PALETTE12,C2:
IFBUTTON(0)THENIFJOYSTK(0)>32THE
N10010ELSEELSE20010
20030 A$=STRING$(40,"$"):PALETTE
13,0:FORX=1TO12:HCOLORX-INT((X-1
)/6)*6+1:HPRINT(0,12-X),A$:HPRIN
T(0,11+X),A$:NEXT:FORX=1TO12:HCO
LOR0:HPRINT(0,12-X),A$:HPRINT(0,
11+X),A$:NEXT
20040 FORX=0TO15:PALETTE,X:NEXT
:WIDTH40:FORX=0TO8:PALETTE,X(C(X)
):NEXT:POKE65496,0:END
25000 RUN
50000 HCOLOR2:HPRINT(32,15),"GAM
E":HPRINT(36,16),"OVER":HCOLOR1:
PL$="T6V2002L16CP16CP16CP16CP16C
P16CP16CP16CP16CECECFCFCECECECE
FDFDGDGDADDFDFDGCACACBCBCGCGD
ADADGDGDFDFDGCCECECECECECECECE
BCBCGCGCECE":PLAY"V31T601"
50005 FORZ=1TO29:PLAY"V-CECE":GO
SUB190:NEXT
50010 E=1:SP=S:RP=R:FORH=1TO10:I
FS>SC(H)THENP=H:H=11:NEXT ELSENE
XT:RETURN
50020 IFP<10THENFORX=9TOP STEP-1
:HI$(X+1)=HI$(X):SC(X+1)=SC(X):N
EXT
50030 SC(P)=S:HI$(P)=". . . .
. . . .":MID$(HI$(P),17-LEN(STR$(
S)),LEN(STR$(S)))=STR$(S):HCOLOR
0:FORX=23TO5STEP-1:HPRINT(2,X),S
TRING$(28,"#"):NEXT
50040 HCOLOR9:HPRINT(8,4),"CONGR
ATULATIONS!":HPRINT(5,7),"You ac
hieved top score":HCOLOR10:HPRIN
T(4,9),RIGHT$(STR$(P),2):HDRAW"B
M26,74R4BD2L4RDNU4BR2NU4":FORX=0
TO21:FORY=0TO6:HCOLOR11:IFHPOINT
(X+25,Y+72)THENHPRINT(5+X,Y+9),"
$"
50050 OJ=26:PALETTE11,RND(63):NE
XTY,X:HCOLOR9:HPRINT(6,17),"Ente
r your initials":A$=INKEY$:CH$=
"ABCDEFGHIJKLMNPOQRSTUVWXYZ.*-":
HCOLOR11:FORPT=0TO2:JC=1:OJ=26
50060 JX=JOYSTK(0):IFJX<10THENJC
=JC-1:IFJC=0THENJC=29ELSEELSEIFJ
X>54THENJC=JC+1:IFJC=30THENJC=1
50065 IFOJ<>JC THENHCOLOR0:HPRIN
T(14+PT*2,20),MID$(CH$,OJ,1):HCO
LOR11:HPRINT(14+PT*2,20),MID$(CH
$,JC,1):OJ=JC:PLAY"O5T255B"
50070 PALETTE11,RND(63):IFBUTTON
(0)THENMID$(HI$(P),PT*2+1,1)=MID
$(CH$,JC,1)ELSEA$=INKEY$:IFINSTR
(CH$,A$)ANDA$<>"THENMID$(HI$(P)
,PT*2+1,1)=A$:HCOLOR0:HPRINT(14+
PT*2,20),MID$(CH$,OJ,1):HCOLOR11
:HPRINT(14+PT*2,20),A$ELSE50060
50080 IFBUTTON(0)THENPALETTE11,R
ND(63):GOTO50080ELSENEXTPT
50090 PALETTE11,63:PLAY PL$:FORX
=1TO20:PLAY"V-CECE":NEXT:GOTO100
10

```

Telewriter-128™

the Color Computer 3 Word Processor

For over 5 years now, Telewriter has been the #1 Color Computer word processor, both in popularity and in performance. Telewriter's near perfect mix of sophisticated professional features and a very natural user interface, has earned it the highest praise in numerous magazines, and an intensely loyal following among tens of thousands of Color Computer users all over the world.

HISTORY

Throughout the history of the Color Computer, Telewriter has pioneered software breakthroughs that set the standards.

In 1981, it was Telewriter 1.0 that first took the Color Computer's inadequate 32X16 all-uppercase display, and replaced it with a graphics-based 51X24 upper and lowercase display.

A few years later, Telewriter-64 added high density 64X24 and 85X24 displays and access to the full 64K of the newer Color Computers.

THE NEW AGE

Today, Telewriter-64 is recognized as the standard Color Computer word processor. It runs on all Tandy Color Computers — from the original Color Computer 1, to the Color Computer 2, and 3.

But the Color Computer 3 brings a whole new level of power to low cost computing and, so, a new Telewriter is here to put that power to work for you. We call it Telewriter-128.

TELEWRITER-128

You don't mess with a good thing, so Telewriter-128 is still Telewriter-64 at heart. The commands, and the user interface are essentially the same. If you know Telewriter-64, then you already know Telewriter-128. And, if you don't know Telewriter-64, you'll still have an easy time learning and using Telewriter-128.

80 COLUMNS

But there are major differences as well. First, Telewriter-128 uses the Color Computer 3's new 80 column screen display.

This means, simply, that using Telewriter-128 on a low cost Color Computer 3 will look a lot like using a more expensive word processor on a much more expensive IBM PC, PS/2, or clone.

SPEED

Second, Telewriter-128 is lightning fast. Telewriter-64 was fast in its own right, but, by accessing the Color Computer 3's video hardware directly, and by running the machine in double speed mode, Telewriter-128 is able to provide extremely fast scrolling and instant paging — functions whose speed is crucial to serious word processing.

In this department, Telewriter-128 doesn't simply keep up with IBM-based word processors — it generally surpasses them!

EASE

Third, Telewriter-128 adds a host of new features big and small, that make it even easier to use.

Features like: Quick function key access to the editor or the menus — an instant on-line help screen summarizing all Telewriter commands and special characters — an option file where you store your personal set of format and screen settings so you only have to set them once!

Then, there's a quick save feature which allows you to save all your current work without leaving the editor. There's a simple way to cursor through the disk directory and read in a file by just hitting ENTER. And there's more.

NEW POWER

Telewriter-64 always had the power to handle any kind of serious writing, from letters to textbooks. But, here too, Telewriter-128 adds major features.

Like Macros — which let you insert whole words or phrases (even sets of control codes or format commands) into your text, with a single keypress. And every time you power up Telewriter-128, the macro definitions are automatically loaded*, so they're always there.

Then there's a Print Preview feature that shows you, on-screen, the way your printed text will look — with margins, headers, centering, justification, page numbering, and page breaks. This guarantees letter perfect documents every time, and makes tasks like widow/orphan line elimination, a breeze.

TELEWRITER-64 OR TELEWRITER-128

We could go on listing features, but the point is this: If you own a Color Computer, you already have the hardware for the most powerful, low cost word processor in town. All you need now is to add the heart and soul:

Telewriter-64, for the Color Computer 1 and 2, costs \$59.95 on disk, \$49.95 on cassette.

Telewriter-128 for the Color Computer 3 costs \$79.95 on disk, \$69.95 on cassette.

To order by Mastercard or Visa call (619) 755-1258 anytime, or send check or money order plus \$2 shipping (Californians add 6% sales tax) to:

COGNITEC

704 Nob Ave.

Del Mar, CA 92014

To upgrade from Telewriter-64 to Telewriter-128, return your original disk or cassette with \$39.95. (Add \$10 if you're also upgrading from cassette to disk. Deduct \$10 with proof of Oct '87 - Feb '88, purchase of Telewriter-64.)

When I first got Telewriter-64 last year, I was in heaven. I couldn't believe the program's versatility and ease of use.

-The RAINBOW, Oct. 1985

TELEWRITER-64 FEATURES: Compatibility with any printer that works with the Color Computer; embedded control codes for underlining, boldface, sub/superscript, variable fonts; format commands for headers, centering, margin and spacing changes anywhere in the document; Format menu to set margins, spacing, page numbering, BAUD rate, lines per page, justification; Chain printing for one shot printing of multi-file documents. Fast, full-screen editor with wordwrap, block copy/move/delete, global search and replace, wild card search, fast 4-way auto-repeat cursor, fast scrolling, forward and backward paging, text alignment, tabs, error protection, word and line counter. Insert or delete text anywhere on the screen. Simple, easy to remember commands. Optional ASCII files for compatibility with spell checkers, terminal programs,

and BASIC. Load, save, append, partial save files to disk or cassette. Kill, rename and list disk files. Cassette verify and auto-retry on error.

TELEWRITER-128 - ADDITIONAL FEATURES: Print preview from editor; multiple copy print; footers; hanging indents; cursor thru disk directory to load, append, rename and kill files; quick file save from editor; keyclick; key repeat; true block move; 24, 25, or 28 line screen; 40 or 80 column screen; dual speed cursor; on-line help; overstrike mode; word delete; wordwrap at margin; user definable macros; nested macros; instant status window for information on cursor position, word count, etc.; instant function key access to menus or editor; options menu for setting character and screen colors, key repeat and delay rates, definable foreign symbols.





A strategy game for two players

One Good Turn Deserves Another

By Eric Tucker

You're leading your opponent by a score of 33 to 30, and it's his move. Only two spaces, E3 and G8, are left on the board. If he picks G8, it's all over for you. Tensely, you wait as he ponders his move. . . .

Flip It is a strategy game designed for a 16K CoCo 2 with Extended Color BASIC. Two people are needed to play.

The game board is an eight-by-eight grid, marked as 1-8 vertically and A-H horizontally. Four markers, two white and two black, are placed on the four center squares. The idea is to place your markers in such a way as to "sandwich" your opponent's markers between two of yours. For example, in Figure 1, a black marker is at B6. Going up diagonally, there are three white markers and a blank space. By placing a black

Eric Tucker is a student at Baruch College, where he is working on his bachelor's degree in computer science. He owns both the MC-10 and the CoCo, but his programming is done exclusively on the CoCo.

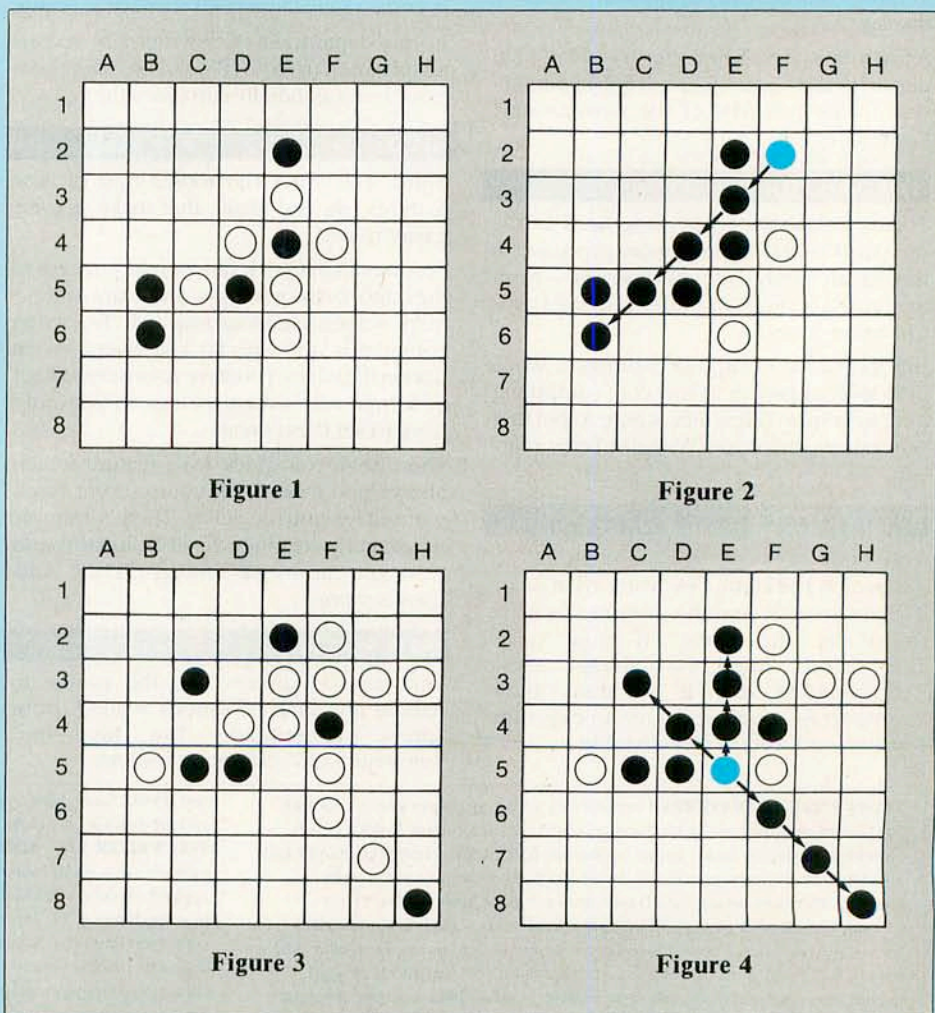

marker at F2, the white markers all "flip" to black (Figure 2).

More than one line can be flipped. In Figure 3, a black marker can be placed at E5. The white markers would be flipped in this order: north, two markers; southeast, two markers; and northwest, one marker. This results in Figure 4. As long as there is a marker of your opponent's color and one of your color opposite a blank space, you can move to that location. Whether horizontally, vertically, or diagonally placed, the markers in between will be flipped.

To type in your coordinates, just

press a key. The screen will clear and ask you for the coordinates (letter, number). If you want to look at the board again before you make your move, just type I,9. The board will reappear, but it will still be your turn. If you type in coordinates that are already occupied, a beep will sound and you will be asked again for the coordinates.

In the upper left-hand corner, a small section of the playing board shows a marker, the color of which shows whose turn it is. The computer keeps track of both players' scores and displays them on the screen. You must place your

marker next to another. Most of the time, you also have to be able to flip something. If either one of these rules is broken, your marker will not be placed on the screen and you will lose your turn. You cannot flip your own color, since it is already yours.

The game ends when either the board is filled or one marker color is wiped out. The winner is the one with the most markers on the board. Good luck!

(Questions or comments regarding this program may be directed to the author at 2950 Park Ave., Apt. 114, Bronx, NY 10451. Please enclose an SASE when requesting a reply.)

✓	9079	740132
	15066	900243
	370121	1020160
	54016	END253

The listing: FLIPIT

```

1Ø REM **** FLIP IT ****
2Ø REM * BY ERIC TUCKER *
3Ø CLS:PRINT@64,"***** F L I
P I T *****":PRINT@96,"(( DE
SIGNED BY ERIC TUCKER ))":PRINT
@192,"TWO PEOPLE ARE NEEDED TO
PLAY.":PRINT@256," <<<<PRESS
ENTER>>>>":EXEC44539
4Ø PMODE3:SCREEN1,Ø:POKE65314,24
8:PCLS2:CIRCLE(128,96),255,1,1,.
65,.35
5Ø LINE(18Ø,Ø)-(182,191),PRESET,
BF:DRAW"C3":LINE(1Ø,1Ø)-(17Ø,17Ø
),PSET,BF
6Ø FORX=1ØTO17ØSTEP2Ø:LINE(X,1Ø)
-(X,17Ø),PRESET:NEXT:FORY=1ØTO17
ØSTEP2Ø:LINE(1Ø,Y)-(17Ø,Y),PRESE
T:NEXT:CIRCLE(6,6),4,1:PAINT(6,6
),1,1
7Ø DRAW"C1BM1Ø,8;BR6U6R4D6U3NL4D
3BR16U6R4D3L4R6D3NL6BR14U6NR4D6R
4BR16U6R2F2D2G2NL2BR18U6NR4D3NR4
D3R4BR16U6NR4D3R4BD3BR16U6NR6D6R
6U3NL2D3BR14U6D3R4U3D6"
8Ø DRAW"BM4,1ØBD4D6R2L4R2U5NL2D5
L2BD16R4D3L4D3R4BD16NL4D3NL4D3L4
BD14D3R4U3D6BD14L4D3R4D3L4BD14BR
4L4D6R4U3L4BD18R4D6BD12L4D6R4U6D
3L4C3"
9Ø LINE(2ØØ,1Ø)-(24Ø,3Ø),PSET,BF
:LINE(21Ø,1Ø)-(21Ø,3Ø),PRESET:LI
NE(23Ø,1Ø)-(23Ø,3Ø),PRESET:LINE(
198,9)-(242,31),PRESET,B:LINE(18
Ø,4Ø)-(255,42),PRESET,BF
1ØØ DRAW"BM196,5ØC1D6R6U3L6R4U3N
L4BR6D6R6BR4U6R4D6U3NL4D3BR4NR4U
6R4BR4D6U3R2NE3F3BD4L4Ø":LINE(18

```

```

Ø,8Ø)-(255,82),PRESET,BF
11Ø DRAW"BM196,9ØD6R4NU4R4U6BR4D
6U3R4U3D6BR4U6BR4R4L2D6BR6NR4U3N
R4U3R4BD1ØL36":LINE(18Ø,12Ø)-(25
5,122),PRESET,BF
12Ø DRAW"BM192,13Ø;ND6R4D3NL4BD3
BR4U6R4D3L4R3D2R1D1R2BR4NR4U3NR4
U3R4BR4NR4D3R4D3NL4BR4R4U3L4U3R4
BR12ND6R4D6U3L4BM2Ø4,14ØD6U3R2NE
3F3R1BR4NR4U3NR4U3R4BR4F4NE4D2"
13Ø DRAW"C4":LINE(2Ø4,15Ø)-(228,
16Ø),PSET,BF:LINE(2Ø4,15Ø)-(228,
16Ø),PRESET,B

```

TEXTFORM

TEXTFORM is compatible with all Color Computers with a minimum of 64K, disk drive, and printer. This machine language program will format ASCII text files into two column pages quickly and easily. This is not another word processor. TEXTFORM is a user definable two column text formatter program which will allow your Color Computer to create very professional documents without hours of tedious work. TEXTFORM is a versatile enhancement to any word processing system whether you are a casual or professional user.

Price.....\$34.95 Special Thru May 31, 1988.....\$27.95

R.A.D. Products
 194 Hotchkiss St., Jamestown, NY 14701
 (716) 665-2124



Terms: Check, C.O.D., Money Order. New York residents add 7% sales tax. C.O.D. orders add \$3.00. All orders add \$3.00 for shipping.

```

140 CIRCLE(80,80),6,1:PAINT(80,8
0),1,1:CIRCLE(100,100),6,1:PAINT
(100,100),1,1:CIRCLE(80,100),6,4
:PAINT(80,100),4,4:CIRCLE(100,80
),6,4:PAINT(100,80),4,4:CIRCLE(2
20,20),6,1:PAINT(220,20),1,1:PC=
1
150 SD$="T6L64V301EEEEV20EEEV15E
EEV10EEEV5EEE"
160 PAINT(220,20),PC,3:GOSUB890:
SOUND200,1:EXEC44539:CLS:IF BS+W
S=64THEN1000
170 IF BS=0 OR WS=0 THEN 1000
180 REM ask for input
190 IF PC=1 THEN PC=128 ELSE PC=
207
200 PRINT"USE 'I,9' TO LOOK AT B
OARD AGAIN":PRINT
210 PRINT"PLAYER: ";STRING$(5,PC
):IFPC=128THENPC=1ELSEPC=4
220 GOTO 240
230 SOUND10,10
240 INPUT"POSITION(LETTER,NUMBER
)";C$,R:SCREEN1,0:POKE65314,248
250 IF C$=""OR R=0THEN160
260 C=ASC(C$)-64
270 IF C=9 OR R=9 THEN 160
280 IF C<0 OR C>8 OR R<0 OR R>8
THEN 230
290 IF C=0 OR R=0 THEN 160
300 X=C*20:Y=R*20:IFPPOINT(X,Y)<
>3THEN230
310 CX=X:CY=Y:REM #1 check
320 REM #2 check--(N)
330 CY=CY-20:IF CY=0 THEN390
340 IFPPOINT(CX,CY)=3THEN390
350 IFPPOINT(CX,CY)<>PC THEN330E
LSE SX=CX:SY=CY:CX=X:CY=Y:CIRCLE
(X,Y),6,PC:PAINT(X,Y),PC,PC
360 CY=CY-20:IF CY=SY THEN 390
370 PLAY SD$
380 CIRCLE(CX,CY),6,PC:PAINT(CX,
CY),PC,PC:GOTO360
390 POKE65314,248:CX=X:CY=Y:REM
#2 check--(NE)
400 CY=CY-20:CX=CX+20:IF CY=0 OR
CX=180 THEN 460
410 IFPPOINT(CX,CY)=3THEN460
420 IFPPOINT(CX,CY)<>PC THEN400E
LSE SX=CX:SY=CY:CX=X:CY=Y:CIRCLE
(X,Y),6,PC:PAINT(X,Y),PC,PC
430 CY=CY-20:CX=CX+20:IFCX=SX AN
D CY=SY THEN 460
440 PLAY SD$
450 PAINT(CX,CY),PC,3:GOTO430
460 POKE65314,248:CX=X:CY=Y:REM
check--(E)
470 CX=CX+20:IFCX=180THEN530
480 IF PPOINT(CX,CY)=3THEN530
490 IFPPOINT(CX,CY)<>PC THEN470E
LSE SX=CX:SY=CY:CX=X:CY=Y:CIRCLE

```

```

(X,Y),6,PC:PAINT(X,Y),PC,PC
500 CX=CX+20:IF CX=SX AND CY=SY
THEN 530
510 PLAY SD$
520 PAINT(CX,CY),PC,3:GOTO500
530 POKE65314,248:CX=X:CY=Y:REM
check--(SE)
540 CX=CX+20:CY=CY+20:IF CX=180O
RCY=180THEN600
550 IF PPOINT(CX,CY)=3THEN600
560 IFPPOINT(CX,CY)<>PC THEN540E
LSE SX=CX:SY=CY:CX=X:CY=Y:CIRCLE
(X,Y),6,PC:PAINT(X,Y),PC,PC
570 CX=CX+20:CY=CY+20:IF CX=SX A
ND CY=SY THEN 600
580 PLAY SD$
590 PAINT(CX,CY),PC,3:GOTO570
600 POKE65314,248:CX=X:CY=Y:REM
check--(S)
610 CY=CY+20:IF CY=180THEN670
620 IF PPOINT(CX,CY)=3THEN670
630 IF PPOINT(CX,CY)<>PC THEN610
ELSE SX=CX:SY=CY:CX=X:CY=Y:CIRCL
E(X,Y),6,PC:PAINT(X,Y),PC,PC
640 CY=CY+20:IF CY=SY THEN 670
650 PLAY SD$
660 PAINT(CX,CY),PC,3:GOTO640
670 POKE65314,248:CX=X:CY=Y:REM
check--(SW)
680 CY=CY+20:CX=CX-20:IF CY=180O
RCX=0THEN740
690 IF PPOINT(CX,CY)=3THEN740
700 IFPPOINT(CX,CY)<>PC THEN680
ELSE SX=CX:SY=CY:CX=X:CY=Y:CIRCL
E(X,Y),6,PC:PAINT(X,Y),PC,PC
710 CX=CX-20:CY=CY+20:IF CX=SX A
ND CY=SY THEN 740
720 PLAY SD$
730 PAINT(CX,CY),PC,3:GOTO710
740 POKE65314,248:CX=X:CY=Y:REM
check--(W)
750 CX=CX-20:IFCX=0THEN810
760 IFPPOINT(CX,CY)=3THEN810
770 IFPPOINT(CX,CY)<>PC THEN750
ELSE SX=CX:SY=CY:CX=X:CY=Y:CIRCL
E(X,Y),6,PC:PAINT(X,Y),PC,PC
780 CX=CX-20:IF CX=SX THEN810
790 PLAY SD$
800 PAINT(CX,CY),PC,3:GOTO780
810 POKE65314,248:CX=X:CY=Y:REM
check--(NW)
820 CX=CX-20:CY=CY-20:IFCX=0ORCY
=0THEN880
830 IFPPOINT(CX,CY)=3THEN880
840 IFPPOINT(CX,CY)<>PC THEN 820
ELSE SX=CX:SY=CY:CX=X:CY=Y:CIRCL
E(X,Y),6,PC:PAINT(X,Y),PC,PC
850 CX=CX-20:CY=CY-20:IF CX=SX A
ND CY=SY THEN880
860 PLAY SD$
870 PAINT(CX,CY),PC,3:GOTO850

```



```

88Ø PLAYSØS:IF PC=1THENPC=4:GOTO
16ØELSEPC=1:GOTO16Ø
89Ø REM CHECK NUMBER OF PIECES
90Ø BS=Ø:WS=Ø:FORW=2ØTO16ØSTEP2Ø
:FORV=2ØTO16ØSTEP2Ø:IFPPOINT(W,V
)=1THENBS=BS+1ELSEIFPPOINT(W,V)=
4THENWS=WS+1
91Ø NEXT:NEXT
92Ø BS$=STR$(BS):WS$=STR$(WS):BS
$=RIGHT$(BS$,LEN(BS$)-1):WS$=RIG
HT$(WS$,LEN(WS$)-1)
93Ø DRAW"C2":LINE(2ØØ,64)-(23Ø,7
2),PSET,BF:LINE(2ØØ,1Ø4)-(23Ø,11
2),PSET,BF:L=LEN(BS$):IFL=2THEND
RAW"BM212,65;C1;"ELSEDRAW"BM214,
65;C1;"
94Ø V1=VAL(LEFT$(BS$,1)):IF V1=Ø
THEN GOSUB 1Ø6Ø ELSE ON V1 GOSU
B 1Ø7Ø,1Ø8Ø,1Ø9Ø,11ØØ,111Ø,112Ø,
113Ø,114Ø,115Ø
95Ø IF L=2 THEN V1=VAL(RIGHT$(BS
$,1)):IF V1=Ø THEN GOSUB 1Ø6Ø EL
SE ON V1 GOSUB 1Ø7Ø,1Ø8Ø,1Ø9Ø,11
ØØ,111Ø,112Ø,113Ø,114Ø,115Ø
96Ø L=LEN(WS$):IF L=2THENDRAW"BM
212,1Ø5;C1;"ELSEDRAW"BM214,1Ø5;C
1;"
97Ø V1=VAL(LEFT$(WS$,1)):IF V1=Ø
THEN GOSUB 1Ø6Ø ELSEON V1 GOSUB
1Ø7Ø,1Ø8Ø,1Ø9Ø,11ØØ,111Ø,112Ø,1
13Ø,114Ø,115Ø
98Ø IF L=2 THEN V1=VAL(RIGHT$(WS
$,1)):IF V1=Ø THEN GOSUB 1Ø6Ø EL
SE ON V1 GOSUB 1Ø7Ø,1Ø8Ø,1Ø9Ø,11
ØØ,111Ø,112Ø,113Ø,114Ø,115Ø
99Ø RETURN
1ØØØ REM end of game
1Ø1Ø CLS:SOUND1,1Ø:FORT=1TO5ØØØ:
NEXT

```

```

1Ø2Ø PRINT@64,"***** F L I P
I T *****":PRINT@128,"BLACK
HAS";BS:PRINT@192,"WHITE HAS";W
S
1Ø3Ø IF WS>BS THEN S$="WHITE"ELS
E IF WS<BS THEN S$="BLACK"
1Ø4Ø IF WS=BS THEN PRINT@256,"
IT'S A TIE GAME."ELSE PRINT@256
,"";S$;" IS THE WINNER."
1Ø5Ø PRINT@32Ø,"ANOTHER GAME";:I
NPUTI$:IFLEFT$(I$,1)="Y"THENRUNE
LSEIFLEFT$(I$,1)="N"THENENDELSE1
Ø5Ø
1Ø6Ø DRAW"R4D6L4U6R4BR4":RETURN
1Ø7Ø DRAW"D6BR4BU6":RETURN
1Ø8Ø DRAW"R4D3L4D3R4BU6BR4":RETU
RN
1Ø9Ø DRAW"R4D3NL4D3NL4BR4BU6":RE
TURN
11ØØ DRAW"D3R4U3ND6BR4":RETURN
111Ø DRAW"NR4D3R4D3NL4BU6BR4":RE
TURN
112Ø DRAW"NR4D6R4U3NL4BU3BR4":RE
TURN
113Ø DRAW"R4ND6BR4":RETURN
114Ø DRAW"R4D6L4U6D3R4U3BR4":RET
URN
115Ø DRAW"R4D3L4NU3BD3R4U6BR4":R
ETURN

```

One-Liner Contest Winner . . .

Has anyone told you to go fly a kite lately? If so, key in this program and fly one indoors.

The listing:

```

54 PMODE3:SCREEN1,Ø:FORX=192TO6Ø
STEP-2:PCLS:DRAW"BM"+STR$(X)+"",1
6ØS16C2E2NF2ULNHRUEHGFDR2C3E12C3
BD3E3H3G3F5S8C4R4NFL4GD4FC3R4NEC
4NR4GD4FR4EU4NHD4C3R4NFL4GD4FR4N
EC4NR4GD4FR4EU4H":NEXT:FORR=1TO8
ØSTEP1:Y=82:K=RND(4):CIRCLE(12Ø,
Y+R),85,K,1,.5,.99:NEXT:RUN

```

Edward R. Gehrke
Nassau, NY

(For this winning one-liner contest entry, the author has been sent copies of both *The Third Rainbow Book of Adventures* and its companion *The Third Rainbow Adventures Tape*.)

TOTHIAN SOFTWARE

DID YOU HEAR ABOUT THE
COCO GRAPHICS PROGRAM
THAT CAN MAKE PICTURES
UP TO 456 PIXELS WIDE
AND 565 PIXELS HIGH ??

?! ? YOU DIDN'T ?! ?

THEN WE'LL BET YOU ARE
HISSING QUITE A FEW
OTHER NEW PRODUCTS TOO.
SOLUTION: WRITE US AND
HAVE YOUR NAME ADDED
TO OUR FREE MAILING
LIST !! NO OBLIGATION.

TOTHIAN SOFTWARE, INC.
BOX 663
RIMERSBURG, PA. 16248
(SINCE 1985)

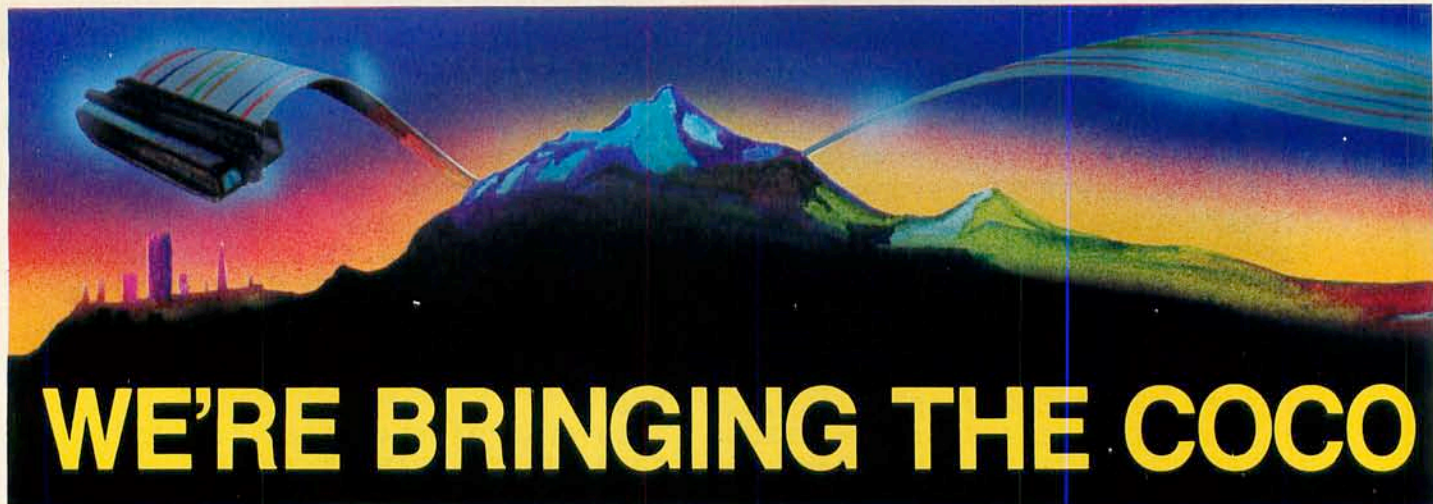

WE'RE BRINGING THE COCO

RAINBOW'S BROADENING ITS SPECTRUM

THE RAINBOW and the Delphi Information Utility have joined together to allow CoCo owners all over the world to connect with one another!

Delphi is a full-service information utility. It offers everything from up-to-the-minute news stories from The Associated Press to electronic mail services. But, *best of all*, it now has a **special forum for Color Computer owners, and it's operated by the people who bring you THE RAINBOW each month.**

The CoCo Special Interest Group (SIG) features a variety of services, including an open forum where you can send and receive messages from Color Computer owners all over the world. It also has several databases to which you can upload your favorite programs and from which you can download programs written by other CoCo enthusiasts. Some of these databases are BASIC programming, OS-9 and home applications.

When setting up your account with Delphi, if you do not have a credit card or prefer not to use it, Delphi requires that you send \$25 to give your account a positive balance. This will be refunded after your first free hour if you choose to no longer use the system or it will be applied to future connect charges. If you do not maintain a positive balance, you will be charged \$3.50 each month for direct billing.

PEEK INTO THE RAINBOW

The CoCo SIG's conference feature allows you to meet electronically with other members of the CoCo Community. You can join conferences with notables such as Dale Puckett, Cray Augsburg, Marty Goodman, Don Hutchison, Jim Reed, Lonnie Falk and others — on a regular basis. Conference schedules will appear in THE RAINBOW each month. Be sure to check online announcements for changes and additions.

THE OTHER SIDE OF THE RAINBOW

On Delphi, you also are able to buy RAINBOW ON TAPE — order a whole set, or download an individual program immediately. You can also renew your RAINBOW subscription, make a fast and easy order for software or hardware from a multitude of vendors, or inquire about products on the CoCo SIG.

We also have a number of **programs that you can download** and use, just for the cost of the time you spend transferring them. There'll also be **corrections for RAINBOW articles**, helpful hints and many other useful features.

FREE LIFETIME MEMBERSHIP

THE RAINBOW is offering subscribers a free lifetime subscription to Delphi — a \$24.95 value — and a free hour of connect time — a \$7.20 value at either 300, 1200 or 2400 Baud — so you can sample Delphi and the RAINBOW CoCo SIG. That's right. Your subscription to THE RAINBOW entitles you to this \$32.15 value as a **free bonus!**

If you're not a RAINBOW subscriber, just enter your order when you sign on with Delphi and you'll get the same great deal! For our \$31 subscription fee, you'll get the finest Color Computer magazine ever, a free lifetime subscription to Delphi and a free hour of connect time.

SAVE EVEN MORE

Want to save even more? While you're online you can order, for only \$29.95, a deluxe package which includes the Delphi membership, the *Delphi Handbook and Command Card* (\$21.95) and a total of three hours of connect time (\$21.60).

Delphi provides us all with **Immediate CoCo Community**. Check it out today. After all, you can sample it for free!

Problems? Call Delphi:
(800) 544-4005
(617) 491-3393

DELPHI

TYPE: GROUP COCO

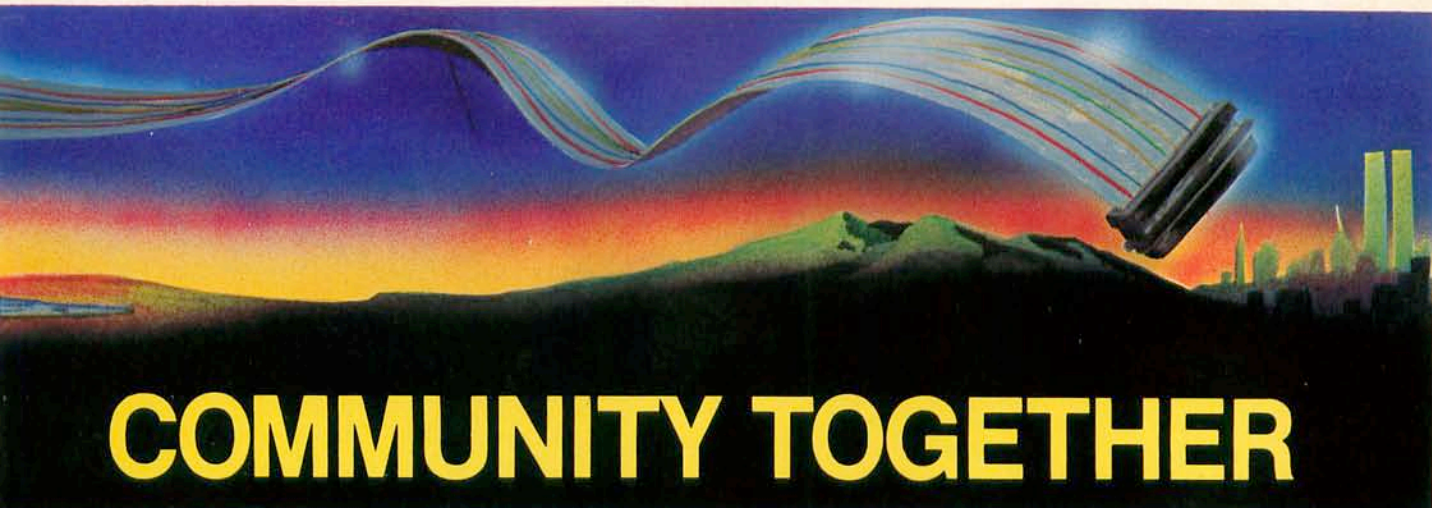

COMMUNITY TOGETHER

How to reach RAINBOW's Color Computer SIG . . .

There are several ways to connect to Delphi and THE RAINBOW's CoCo SIG. In most cities you will not even have to pay long distance charges; you can use special data communications networks like Telenet, Tymnet and the Canadian Datapac network.

First, set your terminal program to operate at either 300 or 1200 Baud (depending on the modem you have), and also select either 7 bits with even parity or 8 bits with no parity, and one stop bit. (If one combination doesn't work, try another.)

Decide which network you should use. There is no surcharge for Telenet or Tymnet. Canadian residents using Datapac will be charged an additional \$10.80 (U.S.) per hour.

On Telenet: Uninet network has merged with Telenet. To get the Telenet number for your area, call (800) 336-0437. After you call the local access number and make connection, press ENTER twice. When the "TERMINAL=" prompt appears, press ENTER again. When the "@" prompt appears, type C DELPHI and press ENTER.

On Tymnet: Call (800) 336-0149 to get the Tymnet number for your area. After you dial your designated number and connect, you will see either "garbage" or a message saying "please type your terminal identifier." At this point, even if the screen is garbled, simply press 'A'. When "please log in:" appears, type DELPHI and press ENTER.

From Canada (on Datapac): Call Delphi Customer Service at (617) 491-3393 to get the Datapac number for your area. After you connect, press the period key (.) and ENTER (use two periods if you're using 1200 Baud). Type SET 2:1, 3:126 and press ENTER. Now type p 1 3106, DELPHI; and press ENTER. Delphi's new rates indicate an additional \$10.80 hourly surcharge for evening use of Datapac, which means a total of \$18 (U.S.) for connect time.

From other countries: Many countries have their own data networks that can connect to either Telenet or Tymnet. Check with the telephone authorities in your country for details on how to sign up for this service. When you have an account set up, you can reach Delphi with a "host code" of 3110 6170 3088 through Telenet, or 3106 90 6015 through Tymnet. (You'll have to pay the toll charges for this connection.)

Type in Your Username

If you're already a subscriber to THE RAINBOW, at the

"USERNAME:" prompt, type JOINDELPHI and press ENTER. At the "PASSWORD:" prompt, type RAINBOW. Then, at the "NUMBER:" prompt, type your individual subscription number from the mailing label of your latest issue of THE RAINBOW. (If there are one or more zeros at the beginning of this number, include them.)

If you don't already have a subscription, at the "USERNAME:" prompt, type JOINDELPHI and press ENTER. At the "PASSWORD:" prompt, type SENDRAINBOW and press ENTER. Have your MasterCard, VISA or American Express card ready, because you'll be led through a series of questions that will enable us to put your RAINBOW and Delphi subscriptions into effect. In an effort to hold down non-editorial costs, we do not bill for subscriptions.

If you make a typing error, just use Control-X and start over. Remember that at any point, when you're on Delphi, you can type HELP to get help on how to use the system. To get off the system just type BYE.

If you find that you're unable to log on to Delphi and enter the CoCo SIG after following these instructions, call us during afternoon business hours at (502) 228-4492. We'll be glad to offer assistance.

Come Visit Us! Type: GROUP COCO

After you sign in, you'll be prompted to set up your own, personal "user name" — Delphi is a friendly service, no numbers to remember — and you'll be asked a number of questions so Delphi can set up your account. You'll also be assigned a temporary password.

Delphi will tell you that your account will be ready after 6 p.m. the same day if you sign up before noon (Eastern time zone.) If not, your account will be ready at 6 p.m. the next day. Once an account is verified and opened, *each RAINBOW subscriber will be credited with an hour of free time!*

When you log back in, use your chosen username and your temporary password to access the system. At that point, you will meet Max, who will help you configure things and will change your temporary password into your own *personal* password. This is the password you will use for subsequent sessions — or until you change it.

After Max bids you goodbye, you'll wind up at the Delphi Main Menu; type in GROUP COCO and **join us on the CoCo SIG!**



Ye Olde Font

By Bill Bernico

I am sure most of you have worked with or at least have seen some of the print font styles used in the commercial graphics editors that are on the market today. Have you ever wished you could use just the font part of that program in your own BASIC program? Up until now you couldn't, with the exception of some standard fonts that have appeared in RAINBOW the past few years.

In the July '84 issue (Page 82), Peter Stumpf showed us how to put graphics characters on the screen to spell out messages. It works great, but in its

Bill Bernico is the author of over 200 Color Computer programs and is a frequent RAINBOW contributor whose hobbies include golf, writing music and programming. Bill is a drummer in a rock band and lives in Sheboygan, Wisconsin.

present form it uses up a lot of variable names and requires quite a few lines to spell out even short messages. That's because you have to join many strings together in order to spell out words.

In the procedure presented here, all the characters are stored in A\$(32) through A\$(122) with the exception of 91-96, since they are seldom used. This procedure works for any of the many font styles since the character-string numbers are the same for each set. They will always be labeled 32-122 to match the ASCII number for that character.

In this sample A\$ contains the message you want to draw on the graphics screen. Lines 1020 through 1060 (the "core" of the program) do the actual drawing of the pre-defined string. Each time you want to spell out a message you have to do three things: Store your message in A\$, define where that message will be drawn, and GOSUB to the

drawing routine, in this case Line 1020.

You may delete my lines 890 through 1010. They are merely samples of how this print font will look on the screen. Substitute your own message using the three-step procedure.

I keep this particular program on a disk in my collection marked "Programming Aids and Tools." Whenever I need a shortcut to get me through a programming procedure, I simply reach for this disk. It also contains a dozen or more other font styles that I have converted to DRAW strings.

Anyone wanting copies of these programs can send me a 22-cent stamp for a paper listing. For disk or tape, send \$1.39 in stamps.

(Questions or comments about this program may be directed to the author at 708 Michigan Ave., Sheboygan, WI 53081. Please enclose an SASE when writing for a response.) □

HD2G2HUND9D2R3ND5FD4LG2L5GE3R3DL
3BU13BR8
39ø A\$(67)="BDBR4G3RG2ND4RD6FNU4
RNU2ED2NR4UR6NE2NUL3U12G3D6EU6ER
5GLU2LUBR6
40ø A\$(68)="BDBR2NR7FR8GR2GRD2NL
2D3NL2D3GNL6GL6GE3U10G3D7G2E3U2L
3GE2R2U4E2R2D5RGD2RGDBU11BR7
41ø A\$(69)="BR4G3ND8RG2D4RED4RNU
2FNU2NR4ER5NE2NUL3U12G3D6EU6ENR7
ER2D2R3G4R4UNL3BU5BR3
42ø A\$(70)="BD6E2DR3UL2EU2D14L2G
R2ERURUHU11R7NUL2UL3ED13GU8R3EL4
U4BUBR8
43ø A\$(71)="BD6D4FDU8E3D9G2U2D3N
R7ERD2R4HU12L2ND8R5HD2R2GR2G4R4H
LD2R2ND3LD3G2BU13BR6
44ø A\$(72)="BD3UNR5ER5EG4D9GRENU
9FRNU11EU11E2NRG2D4RE3D2END9RD7G
2LEBU13BR5
45ø A\$(73)="BD3URUR2D12L2GDR2UEU
11EBR3G2D12L2DRE2U12EBR3
46ø A\$(74)="BD5BRRUL2U2E2R3DL4R6
DL3R5LG3D9GL3G2ER3DRUR3U2RU10ED9
BL3DU9E2RERBUBR3
47ø A\$(75)="BD3E2R3NEGL2FD8G2LGE
5DU8BR2NE2D8G3R4HLD2FURE3D2FU2FR
DH4LF2EH2E3LEL3GE2RBU3BR6
48ø A\$(76)="BD2E2R4EG2NL4D11L2G2
ERENU9RNE3R2F2RNE3HRNE2UE2LHBL3N
U7FU7EBU3BR7
49ø A\$(77)="BR6LG4D11LUREU5L2UR2
U4ERD11NG2U5R6D5EG3H2R3GNU12HU6L
NR5RU5LHR2DR6H2GRGND5R2DR2D12NEH
U11E2BUBR3
50ø A\$(78)="BD3E2D2R3H2D14L3NDER
2EU10RED11NG2U4E3R4GDGDGDGDR4EG2
L2U2RHEUEUEU3L3FRU2L3G3E4RL5E2RG
R2BUBR7
51ø A\$(79)="BR9L4G5ND6RD8R8LGL4U
2LUE2NU8LU7ER6FL3HGD10UE3R3DG3RE
U5FUL3NG2RE2DHULBU3BR6
52ø A\$(80)="BUBD3E3D2LR2HD2LR2ND
14GND13DG3R2GRDFGLNG2DR2D4R3U3NU
13R4GU2L3R5EL2E2DNU7HU2L2G3FRLHE
3REUL3NGR2EU2GU2GL2E2NDBR8
53ø A\$(81)="BR8L3G5ND6RD8R10GR2E
GHL3GL4UHUF2R2NU13R2E4G2DEU9L3HR
3D2LFG3D3DERD4L3G3UBL3NU8EU8EBR11
54ø A\$(82)="BD14E5U8EG2L2GE2RD10
G2E3FG2R5G2HRU2LUENU8ENE4F4DNE3H
2R3H3LNF3UE2U4L4E2D3FR2UL2U2BUBR
8
55ø A\$(83)="BR11G6H3UE2R3D2REL6G
F3NR6L2HG2DED2ED2NR7ENR5RE2L2R8G
R2ND3GD3G3UGU4RNDG5L3HU2R7DH2RL5
R2UBU10BR13
56ø A\$(84)="BD3E2DE2NR5DR9EG2L5D

6G3NU3LU7NE3RG2D3F2E2NU5G2NR2DR8
NE2NULGNL4U12BUBR7
57ø A\$(85)="BD3E2R6EG2L6R4G4ND4R
NED6FU3FD2FU2FR3NE4GNL2U13G2D6GU
5EBR4E3D13E2L3DU11FRBU3BR4
58ø A\$(86)="BD3UE2RG2RD10NLENU11
D2F2NE6H2R3GUHRUNE3U3NE3U6H2BR7N
G3D9ENL3U3NL3U3NL2UHBR4
59ø A\$(87)="BD3E3D14H2RU9LE2RFD1
2GU3FRE2U10GE2D14HUF2DU3RD2NE4U1
3BR2UED11EU9HBR4
60ø A\$(88)="BD3E3D4FU4LGR2D6L3ER
3U4D6GDG2ND2L3NDERFRBR4R4EG3REL2
U2LND2LU5R3GL3D3R2UL2U5EUE2LED3F
U3FDEBU2BR4
61ø A\$(89)="R3GRD10NG3LG2D2ED2NR
3ER4HR5DGBU3L2BU2RL4U10FRUD9UE3R
3D2G2LEURU4L3NGR4DU3GU2GU2GUL2BR
8
62ø A\$(90)="BD3UE2D2LR8U2GNL7D2N
G5LG3L3R8L2GLDR3L8R4G2RERG3UGD2G
UR8GU2R2L7RER5EBU11BR3
63ø A\$(97)="BD6NE3F2G2D2F2U3HD2R
FUR3D2EL2NU9EU8NEL3F2DGNLEU3HBU3
BR6
64ø A\$(98)="RD12NLFNU13FU2FURENU
7RU6L2U2G3U6EBR7
65ø A\$(99)="BD6NE3RD5GR5EG2LGU3L
RU6E2D2ED2EBU5BR3
66ø A\$(100)="BFGDERGR2GR2G4ND4RD
5FU3FD3E3NU6LNGU5NE2ULURBU5BR5
67ø A\$(101)="BD7RNE3D4GRFNU6F2NE
3UEL2ELU2E4L3FU2LBU5BR6
68ø A\$(102)="BR3G2D12LR3GU9L2R4L
2U4EDED2EBU2BR3
69ø A\$(103)="BD17R5EL5E6D5L2EU2L
2GLEL2NU5EU4E3D2ED5EU4EBU4BR3
70ø A\$(104)="BDFD13E2NL3HU10NE2D
6E4GDED9G3ERE2U9BU5BR3
71ø A\$(105)="BD6ED9FE2LGU9RHBU2U
RBUBR4
72ø A\$(106)="BD5ED2ED10GE2U8H2BU
2URBUBR4
73ø A\$(107)="BDFD12HR4G2U13NE2D6
E3R2FL3FRG4ER2GR2D4EUL2U3BU10BR5
74ø A\$(108)="BDFD11NL2DFELU13EBR
3
75ø A\$(109)="BD6UED10HF2ELU9FNRE
2D10FU10FNRE2D10RNE2U9FBU6BR3
76ø A\$(110)="BD5NE2RED9FE2LGU9FN
E2RED2RU2D9FE2LGU8EBU4BR4
77ø A\$(111)="BD7NE4ND4RD5F2UHUF2
E2NU6LU4H2EDFU2BU4BR4
78ø A\$(112)="BD5E2D13LR2NFU5NL2U
7FE2D2ED9GH3R5DL3FE2U6BU5BR3
79ø A\$(113)="BD6NE3ND6RNE2D7FU2F
E2D5NGR2HU9FG2DU5L2EBU4BR6
80ø A\$(114)="BD5NE2RED8HF3E2LGU2

```

GU8FE2D2ED3EUBU5BR3
81Ø A$(115)="BD13NE8R6GLU2NL3BR3
ENU2LU3LD2HL3EL2NU2EU2E2DR4GNL2E
2BU3BR3
82Ø A$(116)="BD4NE3RD9HR2D2EDNE2
HU1ØFRBU4BR4
83Ø A$(117)="BD5NE2RED8FNU9FU3FD
EF2E2L3FU1ØG2R3G2D5U8BU4BR6
84Ø A$(118)="BR3G3RDEUD1ØNLF2NE4
U2RL2ELU7BR4NHD7EU5BU5BR3
85Ø A$(119)="BR2G2D2RU3D12HF2EUG
U9FE2ND9FD8F2E2RGNHEU9NG3FND8BU4
BR3
86Ø A$(12Ø)="BD6E3DGRD2RU2D5G4U3
FRE2RD2RD2E3GLHUHUE4D2HLE2BU3BR3
87Ø A$(121)="BD5NE2RED1ØGDFR3EUG
BH3RNU1ØEDE4NU6LU5G2BU6BR6
88Ø A$(122)="BD7UE3D2ED2EDG4R4HL
D2R3DL2D2EL2DL2GDFR2EBU16BR5
89Ø A$="English Print Font":DRAW
"BM5,5":GOSUB 1Ø2Ø
9ØØ DRAW"BMØ,33R255
91Ø A$="ABCDEFGHIJKLM":DRAW"BMØ,
5Ø":GOSUB 1Ø2Ø

```

```

92Ø A$="NOPQRSTUVWXYZ":DRAW"BMØ,
7Ø":GOSUB 1Ø2Ø
93Ø A$="abcdefghijklm":DRAW"BMØ,
9Ø":GOSUB 1Ø2Ø
94Ø A$="nopqrstuvwxyz":DRAW"BMØ,
11Ø":GOSUB 1Ø2Ø
95Ø A$="*!#$%&'()+.,/-?=":DRAW"B
MØ,13Ø":GOSUB 1Ø2Ø
96Ø A$="Ø123456789:;":DRAW"BMØ,1
5Ø":GOSUB1Ø2Ø
97Ø FORX=1TO15ØØ:NEXT
98Ø PCLS1:A$="brought to you":DR
AW"BM5Ø,3Ø":GOSUB1Ø2Ø
99Ø A$="by Bill Bernico":DRAW"BM
45,55":GOSUB1Ø2Ø
1ØØØ A$="& Rainbow Magazine":DRA
W"BM2Ø,8Ø":GOSUB1Ø2Ø
1Ø1Ø FORX=1TO1ØØØ:NEXT:PCLS1:GOT
O88Ø
1Ø2Ø FOR X=1 TO LEN(A$)
1Ø3Ø Y=ASC(MID$(A$,X,1))
1Ø4Ø IF Y<Ø THEN Y=Ø
1Ø5Ø DRAW A$(Y)
1Ø6Ø NEXT:RETURN

```

SUNDOG SYSTEMS



In Quest of the Star★Lord

A new animated graphic adventure for the Color Computer 3 from the author of the Hall of the King trilogy! Enjoy the mixture of science and fantasy as you quest for the Phoenix Crossbow, the only thing that can save you in the post-holocaust world. A full 4 disk sides of adventure! Outstanding 320x200 graphics will make this your favorite CoCo adventure! Req. 128K CoCo 3 and disk drive. Only \$34.95.



WHITE FIRE OF ETERNITY

64K Animated Graphic Adventure. See 12/86 Rainbow review. Only \$19.95.

Kung-Fu Dude

An exciting new arcade game. This is the long-awaited response to the huge demand for a Kung-Fu program for the CoCo. The graphics, sound effects, and animation are spectacular! This is the BEST karate game ever available for the Color Computer. Req. 64K, disk drive, and joystick. Only \$24.95.

"The CoCo karate gap has been filled and Kung-Fu Dude does it excellently. I highly recommend it!"
-2/88 Rainbow review
"A definite 5 stars!"
-12/87 Wizard's Castle review



CHAMPION

64K Superhero Action Adventure. See 5/87 Rainbow review. Only \$19.95.

All programs CoCo 1, 2, 3 compatible unless stated otherwise.



Sundog Systems
21 Edinburg Drive
Pittsburgh, PA 15235
(412) 372-5674
Personal checks, money orders, and C.O.D. orders accepted.

Include \$2.50 for S/H. \$2.00 extra for C.O.D. orders. PA residents add 6% sales tax. Authorship and dealer inquiries welcome.

Frank Hogg Laboratory

12 Years of Service, Support, and Friendly Help!

DISCOUNT PRICE LIST

CoCo Hard Drive Kits

20 Meg Burke&Burke Kit Complete 539.00

INCLUDES: B&B XT PC interface, M8425 3.5" drive kit with WD controller, 3 foot ST506 cable set, Hard Drive Case (See to the right for specs), OS9 software for LI and LII, Complete instructions. Easy one evening assembly. Requires some expertise but we will help if you run into problems. OPTIONS: RS DOS software (Hyper I/O different (bigger) drives, see list. Call for questions and/or help.

30 Meg Burke&Burke Kit Complete 584.00
(See below for other options)

20 Meg High Speed Kit Complete 766.00

INCLUDES: FHL HCA/WD High Speed interface, M8425 3.5" drive with WD 1002-05 controller, ST506 cable set, 4 foot 40 pin cable, Hard Drive Case (See to the right for specs), OS9 software for LI and LII with source, Complete instructions. Easy one evening assembly. Requires some expertise but we will help if you run into problems. OPTIONS: The case can also hold one 1/2 height floppy drive. Different (bigger) drives, see list. Call for questions and/or help.

40 Meg High Speed Kit Complete 861.00
(See below for other options)

Assemble & Test any of the above add 100.00

CoCo Hard Drive Interfaces

FHL HCA/WD High Speed Interface 119.00

SPECIFICATIONS: Size is the same as a floppy controller. Interfaces the WD 1002-05 controller to the CoCo. This controller handles 3 hard and 4 floppy drives. Type ahead under OS9 for both floppy and hard drive. Includes OS9 LI and LII software with source. Autoboot ROM included to boot from floppy or hard drive. Supports OS9 only. 1 megabyte transfer in 37 seconds!

Burke & Burke XT PC style interface 69.95

SPECIFICATIONS: Size is somewhat larger than a floppy controller. Plugs into the Multi-Pak. Interfaces the WD 1002-WX1 or WD1002-27X controller to the CoCo. This controller handles 2 hard drives. Type ahead under OS9. Includes OS9 LI and LII software. 1 megabyte transfer in 45 seconds! Hyper I/O software is available for RS DOS compatibility.

B&B XT RTC w/battery clock/calendar 99.95

B&B XT ROM (Auto Boot OS9) 19.95

(See software listed under B&B to right)

Hard Drive Controllers

WD 1002-WX1 non RLL for B&B Interface 90.00

WD 1002-27X RLL for B&B Interface 92.00

WD 1002-05 High Speed for FHL Interface 210.00

(Supports both Hard and Floppy drives)

Hard Drives (5.25" & 3.5" HALF HEIGHT)

MiniScribe High Quality Drives - 1 Year Warr.

M8425 20 MB 68MS 3.5" * 285.00

M8425F 20 MB 40MS 3.5" * 317.00

M8438 30 MB RLL 68MS 3.5" * 290.00

M8438F 30 MB RLL 40MS 3.5" * 355.00

M3650 41.9MB 61MS 5.25"/HH 374.00

M6085 71.3MB 28MS Full Height 5.25" 975.00

Seagate drives also available CALL

* These are new 3.5" drives, prices may change by the time this ad comes out. Call for best price. Other drives also available, call for prices.

Floppy Drives (5.25" and 3.5" FLOPPY DISKS)

TEAC High Quality Drives - 1 Year Warr.

FD55B 360K 40 Track DS 5.25" 118.00

FD55F 720K 80 Track DS 5.25: 151.00

FD35F 720K 80 Track DS 3.5" 147.00

(Bare drives, requires case and power supply)

Disk Drive Cases

Hard Drive case with 60W PS and Fan 103.50

SPECIFICATIONS: size 16" deep, 5.5" high, 7" wide. 60 Watt power supply with 3 drive type power connectors, quiet 12 volt DC fan, LED power indicator, color matches CoCo. Holds 2 1/2 height hard or floppy drives and has card guided space for PCB the size of a drive (like the WD1002-05 controller)

Dual Half Height Floppy Case w/PS 75.00

Cables

ST506 Hard disk to controller set 12" 28.00

ST506 Hard disk to controller set 36" 35.00

FHL HCA/WD 40 Pin, 2 connectors 48" 25.00

Floppy cable 34 pin, 2 connectors 36" 20.00

CoCo DECB Software

B&B Hyper I/O run DECB on hard drive 29.95

B&B Hyper III Ramdisk/spooler for above 19.95

eForth closeout continues (Hurry) \$79.95 30.00

CoCo OS9 Level II w/512K Software*

The Wiz \$79.95 69.95

FEATURES: Mac-Like interface with windows, text and binary upload/download with xmodem, kermit, on line HELP, AUTOLOGGING, Macros, VT52 emulation, Usage log and much more. The Wiz requires a RS232 Pak or similar device, LII and 512K.

Sculptor (BIG SALE!!!) \$450.00 149.00

Database - 4th generation language

DynaStar Word Processor \$150.00 125.00

FEATURES: Best OS9 editor/word processor/text formatter, has everything you would expect and more, keyboard macros, supports terminals and windows simultaneously, configurable, auto-indent for C and Pascal programming, index and contents generation, mail merge, bug free, solid, works with big files and much more. New manual makes it easier to use than ever. Most popular word processor since 1982!

DynaSpell spelling checker \$94.50 45.00

by Dale Puckett

Font Editor \$29.95 19.95

Super Sleuth disassembler \$50.00 45.00

FBU Fast Hard disk Back Up \$150.00 75.00

B&B Wild and MV 19.95

Books

Inside OS9 Level II \$39.95 29.95

ORDERING INFORMATION VISA and M/C. NY residents add 7% sales tax. US shipping add \$3.50. Please call for Air Express shipping.

Send for FREE FHL NewsLetter and catalog.

* Most of our software requires OS9 LII and 512K.

Frank Hogg Laboratory, Inc.

770 James Street - Syracuse, NY 13203

Telex 646740

Call 315/474-7856

HARD DISK SYSTEMS INFORMATION

For the best and fastest hard disk systems, trust Frank Hogg Laboratory.

At Frank Hogg Laboratory, we have taken over 3 years of knowledge and expertise in the manufacture of the well known QT 68000 based computers and applied it to the CoCo. Many of the components used in our hard disk systems are the same as that used in the QT!

Hard disk systems have been available for the CoCo for some years now, most are good reliable systems. However we have two new systems for the CoCo that are better. They are just as reliable as other systems, perhaps even more so. But they are both faster and less expensive.

Our top of the line system features Bruce Isted's interface for the Western Digital WD 1002-05 high speed controller. Features; fastest system available, 1 megabyte transfer in 37 seconds!!, twice as fast as older systems!, supports 4 floppy and 3 hard drives, type ahead for both floppy and hard disk, auto boot OS9 L1 or L2 from hard or floppy disk.

Disadvantage; does not support DECB. This is *the* system of choice for the serious OS9 user.

Our second system features the Burke & Burke XT and XT RTC interface. This interface uses popular and inexpensive IBM PC type controllers. For this reason it is the least expensive hard disk system available today. Not as fast as the Isted system but faster than any other system available. It also supports RLL drives. See the price list for other options.

Disadvantage; requires a multi-pak.

Note: DECB support and other software options are listed on our price list.

QT 00x 68000 & QT 20x 68020 Computers

These powerful computers are now available in kit form as well as fully assembled and tested systems. We also do custom systems based on these computers. Kit prices for floppy based QT 00x systems start at only \$1995 while floppy based QT 20x systems start at only \$2650.

All systems include OS9/Professional Operating System with both C and Basic programming languages. Also included is QCom communications and backup software.

Call or write for a brochure.

ANNOUNCEMENT!

FRANK HOGG LABORATORY BUYS OUT INVENTORY OF **Sculptor!** SELLS FOR LESS THAN DISTRIBUTOR COST!!!

Frank Hogg Laboratory purchased the remaining inventory of another Sculptor distributor! Because we got them so low we can offer them to you at tremendous savings.

Sculptor for the CoCo III with OS9 Level II* is

ONLY \$149

\$149 is below distributor cost! The list price is \$450!! Once they are gone the prices will go back to normal. This is a great opportunity to buy the most powerful Database/4th Generation Language available today!! * Requires OS9 LII and 512K.

They won't last long.
Hurry and get yours today!!!!

**Also on SALE *Sculptor* MS/DOS \$149
Sculptor OS9/68K \$499**

**See Dale Puckett's February and March
1988 Rainbow columns for more
information on this great package.**

ORDERING INFORMATION VISA and M/C. NY residents add 7% sales tax. US shipping add \$3.50. Please call for Air Express shipping.

Send for your FREE FHL NewsLetter and Catalog.

* Most of our software requires OS9 LII and 512K.

Frank Hogg Laboratory, Inc.

770 James Street - Syracuse, NY 13203
Telex 646740

Call 315/474-7856



*Dumping CoCo 3 graphics screens
to the CGP-220*

CoCo 3 Color Dump

By Duane M. Perkins

Viewed on an RGB monitor, the 16-color graphics from a CoCo 3 are truly impressive. Wouldn't it be nice if they could be printed in hard-copy form? Well, here are the programs you will need to dump those screens to a CGP-220 Color Ink Jet Printer.

You will need a machine language subroutine to generate output to the printer. Listing 1 is the printout from *EDTASM*. This code is included in the BASIC program in Listing 5. The parameter passed from BASIC is a pointer to a string descriptor. The string contains Hex codes for each of 16 permutations that are used to select the color of the pixels. Each pixel consists of a 2-by-2 array of four dots. Two diagonally opposite dots are printed with the color code from one of the Hex digits, and the other two dots are printed with the color code of the other Hex digit. Each Hex digit of the Hi-Res screen memory contains the palette slot number used to select the color for the dot on the screen that corresponds positionally to the Hex code in screen memory. When the screen is printed, each Hex digit is similarly used to select one of the 16 bytes in the color code string.



The subroutine does not print directly from the Hi-Res screen memory. The data must be moved to the upper 64K block, starting at \$4000. After printing 15K, the subroutine returns to BASIC. Another 15K segment can then be printed. Two segments are required to print a full 16-color Hi-Res screen. This approach allows the flexibility of printing data from any source, not necessarily the Hi-Res screen memory. The BASIC program in Listing 2 generates the data to print color patches corresponding to each of the 64 permutations (see Figure 1). The ML code is in lines 410 through 430. The pokes in Line 70 modify the ML so that only 10 lines are printed on each call. After printing the patches, you can use the

color chart to select codes for the color code string in Listing 5.

Listing 3 is a BASIC program to save a Hi-Res screen to four disk files; the first three are 8K and the last is 6K. The extension identifies the files sequentially from 0 to 3. Listing 4 is a BASIC program to load the four files and display the screen. Listing 5 is a program that will load and print the four files. The ML code is in lines 200 through 220.

You can use the program in Listing 6 to create pie charts. Set N (Line 10) to the number of slices and code DATA statements (replace lines 380 through 510) with the size, color and label of each slice. The size must be expressed as a fraction of the pie and the sum of

Duane M. Perkins retired as director of management information systems at the Panama Canal. His interests include electronics and computers, and he has had a number of articles published in Modern Electronics.

CGP-220 HEXADECIMAL COLOR CODES: 0=BLK 1=RED 2=GRN 3=YEL 4=BLU 5=MAGENTA 6=CYAN 7=WHT

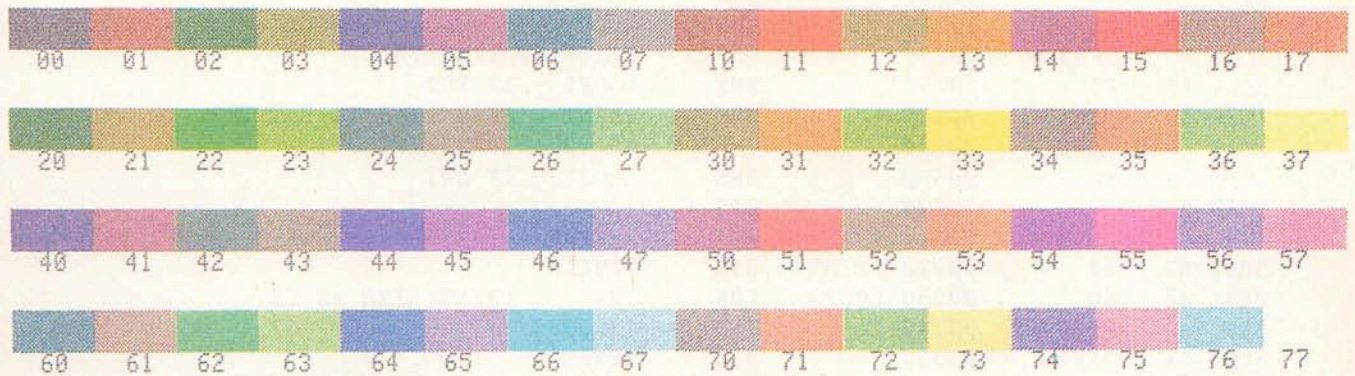

Figure 1: CGP-220 Color Codes

these should be unity. The color code must range from 0 to 15. The label may be up to eight characters in length. As shown in Figure 2, the colors of the slices are selected from palette slots 2 to 15; each is one-fourteenth of the pie. The background and foreground colors are selected from slots 0 and 1. When the chart is printed, the colors will be selected from the bytes in the color code string that correspond to the respective palette slots.

To use these programs, you must first create a screen using HSCREEN 2. Run the program in Listing 3 to save the screen. You can try different colors by using the PALETTE command and running the program in Listing 4. When you are satisfied, run the program in Listing 6 with the palette set up as it was for the screen to be printed. The screen will show a color wheel with the colors labeled in accordance with the palette slot numbers. Select a set of Hex codes from the printout of Listing 2 that you want to substitute for the colors on the screen. You can select the nearest match for each corresponding palette slot color or substitute any color you

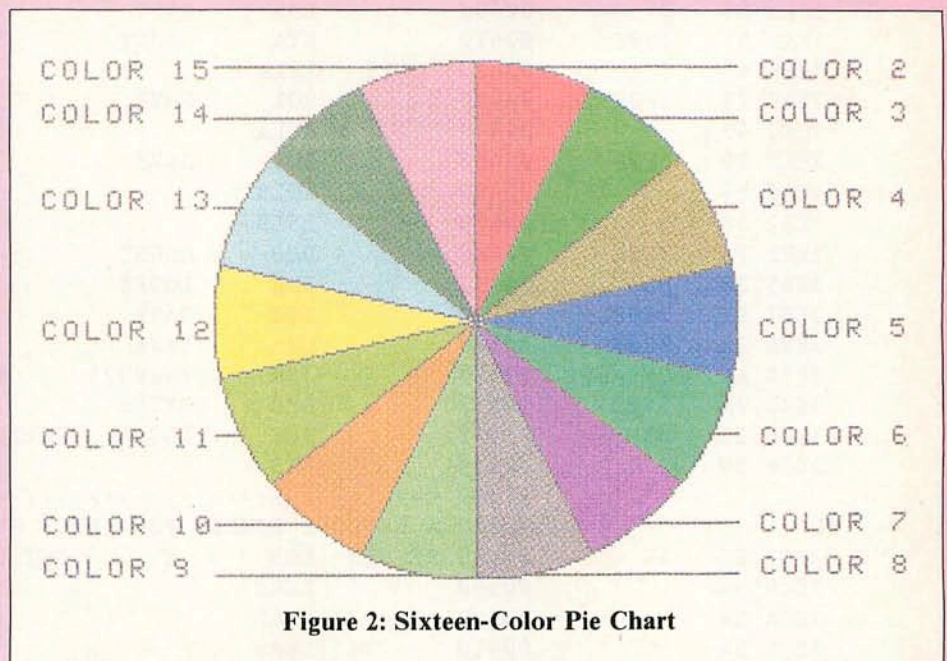

Figure 2: Sixteen-Color Pie Chart

choose. Change Line 80 of Listing 5 accordingly and run the program. Keep in mind that the first two characters are the codes for the background and foreground, respectively.

(Questions or comments regarding these programs may be directed to the author at P.O. Box 255, Mt. Gretna, PA 17064. Please enclose an SASE when requesting a reply.)

Listing 1:

```

00100 TITLE LISTING 1
00110 * PRINT 4-DOT PIXELS
00120 *-----
3E69 00130 ORG $3E69
3E69 BD B3ED 00140 ENTER JSR $B3ED
3E6C 1F 01 00150 TFR D,X
3E6E EE 02 00160 LDU 2,X POINT TO COLOR CODE STRING
3E70 108E 4000 00170 LDY #$4000 INPUT DATA
3E74 86 FE 00180 LDA #-2
3E76 97 6F 00190 STA $6F OUTPUT TO PRINTER
00200 *-----
3E78 8E 3F10 00210 LOOP1 LDX #LINE

```

```

3E7B 8D 4A 00220 LOOP2 BSR SETPIX
3E7D 8D 48 00230 BSR SETPIX
3E7F 30 01 00240 LEAX 1,X
3E81 8C 3F60 00250 CMPX #LINE+80 LINE FULL?
3E84 26 F5 00260 BNE LOOP2 IF NOT
3E86 8D 07 00270 BSR PRINT SEND LINE TO PRINTER
3E88 108C 7C00 00280 CMPY #$7C00 15K PRINTED?
3E8C 26 EA 00290 BNE LOOP1 IF NOT
3E8E 39 00300 RTS
00310 *-----
3E8F 8D 62 00320 PRINT BSR NEWLIN
3E91 A6 80 00330 LOOP3 LDA ,X+ PRINT LINE AS IS
3E93 AD 9F A002 00340 JSR [$A002]
3E97 7A 3F0D 00350 DEC BYTES
3E9A 26 F5 00360 BNE LOOP3 UNTIL LINE SENT ONCE
3E9C 8D 55 00370 BSR NEWLIN
3E9E A6 80 00380 LOOP4 LDA ,X+ TRANSPOSE ADJACENT BITS
3EA0 B7 3F0F 00390 STA SAVE
3EA3 86 04 00400 LDA #4
3EA5 B7 3F0E 00410 STA COUNT
3EA8 48 00420 LOOP5 LSLA
3EA9 79 3F0F 00430 ROL SAVE
3EAC 49 00440 ROLA
3EAD 79 3F0F 00450 ROL SAVE
3EB0 59 00460 ROLB
3EB1 58 00470 LSLB
3EB2 7A 3F0E 00480 DEC COUNT
3EB5 26 F1 00490 BNE LOOP5
3EB7 F7 3F0F 00500 STB SAVE
3EBA BA 3F0F 00510 ORA SAVE
3EBD AD 9F A002 00520 JSR [$A002]
3EC1 7A 3F0D 00530 DEC BYTES
3EC4 26 D8 00540 BNE LOOP4 UNTIL LINE SENT TWICE
3EC6 39 00550 RTS
00560 *-----
00570 * SETUP 2 PIXELS PER INPUT BYTE
3EC7 E6 A4 00580 SETPIX LDB ,Y GET LEFT HEX
3EC9 54 00590 LSRB
3ECA 54 00600 LSRB
3ECB 54 00610 LSRB
3ECC 54 00620 LSRB
3ECD 8D 07 00630 BSR SETRGB EVEN NUMBER PIXEL
3ECF E6 A0 00640 LDB ,Y+ GET RIGHT HEX
3ED1 C4 0F 00650 ANDB #$0F
3ED3 8D 01 00660 BSR SETRGB ODD NUMBER PIXEL
3ED5 39 00670 RTS
00680 *-----
00690 * SET RED, GRN & BLU BITS FOR ONE PIXEL
3ED6 A6 C5 00700 SETRGB LDA B,U COLOR CODES
3ED8 48 00710 LSLA
3ED9 48 00720 LSLA
3EDA 69 89 00A0 00730 ROL 160,X LEFT BLU
3EDE 48 00740 LSLA
3EDF 69 88 50 00750 ROL 80,X LEFT GRN
3EE2 48 00760 LSLA
3EE3 69 84 00770 ROL ,X LEFT RED
3EE5 48 00780 LSLA
3EE6 48 00790 LSLA
3EE7 69 89 00A0 00800 ROL 160,X RIGHT BLU

```

```

3EEB 48          00810      LSLA
3EEC 69      88 50      00820      ROL      80,X      RIGHT GRN
3EEF 48          00830      LSLA
3EF0 69      84          00840      ROL      ,X      RIGHT RED
3EF2 39          00850      RTS
                 00860 *-----
3EF3 C6      03          00870 NEWLIN LDB      #3      START A NEW OUTPUT LINE
3EF5 8E      3F0A      00880      LDX      #MODE
3EF8 A6      80          00890 LOOP6   LDA      ,X+
3EFA AD      9F A002     00900      JSR      [$A002]
3EFE 5A          00910      DECB
3EFF 26      F7          00920      BNE      LOOP6
3F01 86      F0          00930      LDA      #240
3F03 B7      3F0D      00940      STA      BYTES
3F06 8E      3F10      00950      LDX      #LINE
3F09 39          00960      RTS
                 00970 *-----
3F0A          1B43      00980 MODE   FDB      $1B43  COLOR SCAN MODE
3F0C          50          00990      FCB      80      ROWS PER LINE
3F0D          01000 BYTES  RMB      1
3F0E          01010 COUNT  RMB      1
3F0F          01020 SAVE   RMB      1
3F10          01030 LINE   RMB      240
                 01040 *-----
                 3E69      01050      END      ENTER

```

000000 TOTAL ERRORS

Listing 2: COLORS

```

10 CLEAR 200,&H3E68
20 PRINT"PLEASE WAIT"
30 POKE &H96,&H12:'2400 BAUD
40 FOR A=&H3E69 TO &H3F0C
50 READ H$:POKE A,VAL("&H"+H$)
60 NEXT A
70 POKE &H3E8A,&H46:POKE &H3E8B,
&H40
80 DEF USR0=&H3E69
90 FOR A=16384 TO 17824 STEP 160
100 FOR C=0 TO 15
110 FOR B=0 TO 9
120 POKE A+B+10*C,16*C+C
130 NEXT B:NEXT C:NEXT A
140 PRINT#-2,"CGP-220 HEXADECIMA
L COLOR CODES: 0=BLK 1=RED 2=GRN
3=YEL 4=BLU 5=MAGENTA 6=CYAN 7=
WHT"
150 C$="":FOR C=0 TO 7
160 C$=C$+CHR$(C):NEXT C
170 FOR C=&H10 TO &H17
180 C$=C$+CHR$(C):NEXT C
190 X=USR0(VARPTR(C$))
200 PRINT#-2," 00 01 02
03 04 05 06 07 10
11 12 13 14 15
16 17"

```

NEW FROM K-SOFT

FROGDAY AFTERNOON

It ain't easy being a Frogman, and somebody's gotta keep the subs and torpedos and squids off his back. That's you!

You won't want to quit!

8 Levels - Disk only
Not Protected - Coco 3 only

ZANDAR

(See Feb. and March Ads in Rainbow)

\$24.95 each
Spring Special
Save \$15 - Both for \$34.90

WA State residents add 7.5% sales tax
Overseas send U.S. Money Order

Check - Money Order - C.O.D.
Phone (509) 884-0338



K-Soft
300 13th N.E.
E. Wenatchee, WA 98802

NEW FROM K-SOFT

SPRING 1988

SPRING 1988

Rainbowfest Sale

April 10th
thru May 31st

If you can't make it Rainbowfest,
you can still make it to the sale.

Speech

EARS (Now you can really talk to your computer).....	\$99.95	\$69.95
SUPER VOICE (COCO's Premier Speech Synthesizer)	\$79.95	\$49.95
VOICE CONTROL (Control your TV with your voice).....	\$24.95	\$19.95
RS TRANSLATOR (Enhance your RS Speech & Sound cartridge)	\$24.95	\$19.95

Music

SYMPHONY 12 (A real 12 voice music synthesizer).....	\$69.95	\$49.95
MUSICA 2 (Complete 4 voice music composition & printing program)	\$29.95	\$19.95
MUSIC LIBRARY (900 songs, 100 per volume).....	\$29.95	\$19.95
STEREO PAK (Make Music in Stereo with MUSICA).....	\$39.95	\$29.95

MIDI Music

COCO MIDI 2 (Complete hardware & software for MIDI)	\$149.95	\$99.95
MUSICA MIDI (Play MUSICA Files to your MIDI synth, includes cable) ...	\$39.95	\$29.95
LYRA (The musical COCO MAX).....	\$54.95	\$39.95
LYRA PRINT (Print your music)	\$29.95	\$19.95
LYRA LYBRARY (50 songs of 7 & 8 voice music, 3 disks).....	\$39.95	\$29.95
LYRA LYBRARY Supplement 1 (More LYRA music).....	\$29.95	\$19.95
LYRA LYBRARY Supplement 2 (Even More)	\$29.95	\$19.95
LYRA LYBRARY Supplement 3 (Still more)	\$29.95	\$19.95
LYRA LYBRARY Supplement 4 (Even Still more).....	\$29.95	\$19.95

Extras

TRIPLE Y-Cable (Connect 3 hardware paks together).....	\$34.95	\$24.95
DOUBLE Y-Cable (Connect 2 hardware paks together).....	\$28.95	\$18.95
PROTO BOARD & CASE (For the experimenter)	\$29.95	\$9.95

For Your COCO 3

512K TURBO RAM (Complete memory upgrade with extras).....	\$119.95	\$89.95
512K TURBO RAM W/O Chips	\$69.95	\$34.95

***** FREE Disk or Tape With Order *****

See December 87 Rainbow pages 40,41,42,43,44,45 For Detailed Product Information

EARS™

Electronic
Audio
Recognition
System

\$99.95

Now Your
Computer
Can Listen
To You!

- SPEECH RECOGNITION
- HANDS OFF PROGRAMMING
- HIGH QUALITY SPEECH REPRODUCTION

EARS Does It All!

INCREDIBLE!



CoCo 3
Compatible

Two Years In the Making. Speech Systems was formed to develop new and innovative speech products. After 2 years of intensive Research and Development, we have created a truly sophisticated speech recognition device. Recognition rates from 95% to 98% are typical. Until now, such a product was outside the price range of the personnel computer market, and even small businesses.

EARS is trained by your voice and capable of recognizing any word or phrase. Training EARS to your particular voice print takes seconds. Up to 64 voice prints may be loaded into memory. You may then save on tape or disk as many as you like so that your total vocabulary is virtually infinite.

Speech and Sound Recognition. EARS is really a sound recognition system, so it really doesn't matter whether you speak in English, Spanish, or French. In fact you do not have to speak at all, you can train EARS to understand sounds such as a musical note or a door slamming.

Hands Off Programming. Imagine writing your own BASIC programs without ever touching the keyboard. Everything that

you would normally do through a keyboard can now be done by just speaking.

Programming EARS Is Easy. LISTEN, MATCH and other commands have been added to BASIC so that programming EARS is a piece of cake! The single BASIC line: 10 LISTEN: MATCH will instruct EARS to listen to you and return the matching phrase.

It Talks. EARS is also capable of high quality speech. We mean REALLY high quality. The speech is a fixed vocabulary spoken by a professional announcer. Speech Systems is currently creating a library of thousands of high quality words and phrases. For a demonstration call (312) 879-6844, you won't believe your ears or our EARS.

DISK OWNERS. EARS will work with any disk system with either a MULTI-PAK or Y-CABLE. Our new Triple Y-CABLE was specifically developed for those wishing to add SUPER VOICE as a third device.

You Get Everything You Need. You get everything you need including a specially designed professional headset style noise

cancelling microphone. The manual is easy to use and understand. Several demonstration examples are included so you don't have to write your own programs unless you want to. EARS will work in any 32K or 64K Color Computer.

SUPER VOICE \$20 OFF

Imagine talking to your computer and it talking back to you. When you need an unlimited vocabulary, you can't beat SUPER VOICE. For a limited time, we will give you the SUPER VOICE for \$59.95 with your EARS purchase. Even if you already have another speech unit, here is your chance to buy the best and save \$20.

VOICE CONTROL

Applications for EARS are astounding. Here is our first of many listening programs to come. VOICE CONTROL is a program specifically designed to allow you to control any appliance in your house with your voice and our HOME COMMANDER (sold separately) or the Radio Shack Plug 'N' Power controller. For example, you can control your TV by saying "TV ON" or "TV OFF". . . \$24.95

FREE
BLANK DISK
OR TAPE
WITH EVERY
ORDER



Dealer Inquiries
Invited



Speech Systems

38W255 DEERPATH ROAD
BATAVIA, ILLINOIS 60510
(312) 879-6880 (TO ORDER)

We accept CASH, CHECK, COD, VISA and MASTER CARD orders.

Shipping and handling US and Canada	\$3.00
Shipping and handling outside the US and Canada	\$5.00
COD charge	\$2.00

Illinois residents add 6¼% sales tax

CALL ANY DAY TO ORDER. ALSO ORDER BY MAIL

```

210 C$="":FOR C=&H20 TO &H27
220 C$=C$+CHR$(C):NEXT C
230 FOR C=&H30 TO &H37
240 C$=C$+CHR$(C):NEXT C
250 X=USR0(VARPTR(C$))
260 PRINT#-2," 20 21 22
 23 24 25 26 27 30
 31 32 33 34 35
36 37"
270 C$="":FOR C=&H40 TO &H47
280 C$=C$+CHR$(C):NEXT C
290 FOR C=&H50 TO &H57
300 C$=C$+CHR$(C):NEXT C
310 X=USR0(VARPTR(C$))
320 PRINT#-2," 40 41 42
 43 44 45 46 47 50
 51 52 53 54 55
56 57"
330 C$="":FOR C=&H60 TO &H67
340 C$=C$+CHR$(C):NEXT C
350 FOR C=&H70 TO &H77
360 C$=C$+CHR$(C):NEXT C
370 X=USR0(VARPTR(C$))
380 PRINT#-2," 60 61 62
 63 64 65 66 67 70
 71 72 73 74 75
76 77"
390 POKE &H6F,0:PRINT"DONE"
400 END
410 DATA BD,B3,ED,1F,01,EE,02,10
,8E,40,00,86,FE,97,6F,8E,3F,10,8
D,4A,8D,48,30,01,8C,3F,60,26,F5,
8D,07,10,8C,7C,00,26,EA,39,8D,62
,A6,80,AD,9F,A0,02,7A,3F,0D,26,F
5,8D,55,A6,80,B7,3F,0F,86,04,B7,
3F,0E,48,79,3F,0F,49,79,3F,0F,59
,58,7A,3F,0E,26,F1,F7,3F
420 DATA 0F,BA,3F,0F,AD,9F,A0,02
,7A,3F,0D,26,D8,39,E6,A4,54,54,5
4,54,8D,07,E6,A0,C4,0F,8D,01,39,
A6,C5,48,48,69,89,00,A0,48,69,88
,50,48,69,84,48,48,69,89,00,A0,4
8,69,88,50,48,69,84,39,C6,03,8E,
3F,0A,A6,80,AD,9F,A0,02,5A,26,F7
,86,F0,B7,3F,0D,8E,3F,10
430 DATA 39,1B,43,50

```

Listing 3: HRSAVE

```

"
10 F$="HRESFILE"
20 FOR N=&H30 TO &H32
30 POKE &HFFA2,N
40 SAVEM F$+"/HR"+CHR$(N),&H40000
,&H5FFF,&H40000
50 NEXT N
60 POKE &HFFA2,&H33
70 SAVEM F$+"/HR3",&H40000,&H57FF
,&H40000
80 POKE &HFFA2,&H3A

```

Listing 4: HRLOAD

```

10 F$="HRESFILE"
20 HSCREEN 2
30 FOR N=&H30 TO &H32
40 POKE &HFFA2,N
50 LOADM F$+"/HR"+CHR$(N)
60 NEXT N
70 POKE &HFFA2,&H33
80 LOADM F$+"/HR3"
90 POKE &HFFA2,&H3A
100 GOTO 100

```

Listing 5: CGPPRINT

```

10 CLEAR 200,&H3E68
20 POKE &H96,&H12:'2400 BAUD
30 FOR A=&H3E69 TO &H3F0C
40 READ H$:POKE A,VAL("&H"+H$)
50 NEXT A
60 DEF USR0=&H3E69
70 F$="HRESFILE"
80 C$=CHR$(&H77)+CHR$(&H00)+CHR$
(&H15)+CHR$(&H22)+CHR$(&H30)+CHR
$(&H46)+CHR$(&H26)+CHR$(&H54)+CH
R$(&H07)+CHR$(&H27)+CHR$(&H13)+C
HR$(&H23)+CHR$(&H33)+CHR$(&H76)+
CHR$(&H02)+CHR$(&H57)
90 LOADM F$+"/HR0"
100 LOADM F$+"/HR1",&H20000
110 X=USR0(VARPTR(C$))
120 FOR A=&H40000 TO &H43FF
130 POKE A,PEEK(A+&H3C00)
140 NEXT A
150 LOADM F$+"/HR2",&H4000
160 LOADM F$+"/HR3",&H24000
170 X=USR0(VARPTR(C$))
180 POKE &H6F,0:PRINT"DONE"
190 END
200 DATA BD,B3,ED,1F,01,EE,02,10
,8E,40,00,86,FE,97,6F,8E,3F,10,8
D,4A,8D,48,30,01,8C,3F,60,26,F5,
8D,07,10,8C,7C,00,26,EA,39,8D,62
,A6,80,AD,9F,A0,02,7A,3F,0D,26,F
5,8D,55,A6,80,B7,3F,0F,86,04,B7,
3F,0E,48,79,3F,0F,49,79,3F,0F,59
,58,7A,3F,0E,26,F1,F7,3F
210 DATA 0F,BA,3F,0F,AD,9F,A0,02
,7A,3F,0D,26,D8,39,E6,A4,54,54,5
4,54,8D,07,E6,A0,C4,0F,8D,01,39,
A6,C5,48,48,69,89,00,A0,48,69,88
,50,48,69,84,48,48,69,89,00,A0,4
8,69,88,50,48,69,84,39,C6,03,8E,
3F,0A,A6,80,AD,9F,A0,02,5A,26,F7
,86,F0,B7,3F,0D,8E,3F,10
220 DATA 39,1B,43,50

```

Listing 6: COLORPIE

```

10 N=14

```



```

20 DIM F(N),C(N),S$(N)
30 FOR I=1 TO N
40 READ F(I),C(I),S$(I)
50 NEXT I:Z=96:HSCREEN 2
60 FOR X=0 TO 96
70 Y=INT(SQR(9216-X*X)+.5)
80 IF Y=Z OR Y=Z+1 THEN 140
90 HSET(160-X,96-Z)
100 HSET(160+X,96-Z)
110 HSET(160-X,96+Z)
120 HSET(160+X,96+Z)
130 Z=Z-1:GOTO 80
140 HSET(160-X,96-Y)
150 HSET(160+X,96-Y)
160 HSET(160-X,96+Y)
170 HSET(160+X,96+Y)
180 Z=Y-1:NEXT X
190 HLINE(160,0)-(160,96),PSET
200 FOR I=0 TO N
210 B=A
220 A=A+6.28318*F(I)
230 AA=A:R=96:GOSUB 350:S=SGN(X)
240 XX=160+X:YY=96-Y
250 HLINE(160,96)-(XX,YY),PSET
260 AA=A-(A-B)/2:R=48:GOSUB 350
270 HPAINT(160+X,96-Y),C(I),1
280 R=96:GOSUB 350
290 HLINE(160+X,96-Y)-(160+SGN(X)
)*96,96-Y),PSET
300 X=0:Y=INT((96-Y)/8)
310 IF A<3.1416 THEN X=40-LEN(S$(I))
320 HPRINT(X,Y),S$(I)
330 NEXT I
340 GOTO 340
350 X=INT(R*SIN(AA)+.5)
360 Y=INT(R*COS(AA)+.5)
370 RETURN
380 DATA .07142857143,2,COLOR 2
390 DATA .07142857143,3,COLOR 3
400 DATA .07142857143,4,COLOR 4
410 DATA .07142857143,5,COLOR 5
420 DATA .07142857143,6,COLOR 6
430 DATA .07142857143,7,COLOR 7
440 DATA .07142857143,8,COLOR 8
450 DATA .07142857143,9,COLOR 9
460 DATA .07142857143,10,COLOR 1
0
470 DATA .07142857143,11,COLOR 1
1
480 DATA .07142857143,12,COLOR 1
2
490 DATA .07142857143,13,COLOR 1
3
500 DATA .07142857143,14,COLOR 1
4
510 DATA .07142857143,15,COLOR 1
5

```

SPECIAL EVENT!

COCO GALLERY LIVE SHOWCASE YOUR BEST AT RAINBOWFEST

We are taking the popular "CoCo Gallery" on the road to RAINBOWfest Chicago — and we'd like you to submit your own graphics creations to be exhibited at the show!

RULES

- You can enter color or black-and-white photographs or printouts of your original artwork produced on the CoCo 1, 2 or 3. Entries should be framed, mounted or matted, and may not be smaller than 5-by-7 inches or larger than 11-by-14 inches.
- Don't send us anything owned by someone else; this means no game screens, digitized images from TV programs or material that's already been submitted elsewhere. A digitized copy of a picture that appears in a book or magazine is *not* an original work.
- Along with your entry, send a cover letter with your name, address and phone number, detailing how you created your picture (what programs you used, etc.). Please include a few facts about yourself, too!
- Your name, address and phone number, along with the title of your work, must be clearly marked on the back of each entry, and a disk copy of each piece must also be included.
- Entries may be mailed to THE RAINBOW before May 1, 1988, or brought to the RAINBOWfest registration booth by 10 a.m., Saturday, May 21.
- Your work will be returned if sent with a postage paid return envelope, or entries can be picked up at the close of the show — Sunday, May 22, at 4 p.m.

There will be two categories: one for graphics produced on the CoCo 1 and 2, and one for CoCo 3 graphics. Several awards will be made in each category. Winners will be determined by votes from RAINBOWfest attendees. In case of any ties, winners will be determined by our chief judge, CoCo Cat.

Prizes and ribbons will be presented Sunday, May 22, and winning entries will be published in the September '88 issue of THE RAINBOW. Send your entry to "CoCo Gallery Live," THE RAINBOW, 9509 U.S. Highway 42, Prospect, KY 40059.

RAINBOW FEST

CHICAGO MAY 20-22

RAINBOWfest is the only computer show dedicated exclusively to your Tandy Color Computer.

Nowhere else will you see as many CoCo-related products or be able to attend free seminars conducted by the top Color Computer experts. It's like receiving the latest issue of THE RAINBOW in your mailbox!

RAINBOWfest is a **great opportunity** for commercial programmers to show off new and innovative products for the first time. Chicago is the show to get information on capabilities for the new CoCo 3, along with a terrific selection of the latest CoCo 3 software. In exhibit after exhibit, there will be demonstrations, opportunities to experiment with software and hardware, and special RAINBOWfest prices.

Set your own pace between visiting exhibits and attending the valuable, free seminars on all aspects of your CoCo — from improving BASIC skills to working with the sophisticated OS-9 operating system.

Many people who write for THE RAINBOW — as well as those who are written about — are there to meet you and answer questions. You'll also meet lots of other people who share your interest in the Color Computer. It's a person-to-person event and a tremendous learning experience in a fun and relaxed atmosphere.

A special feature of RAINBOWfest is the Educational Sandbox, which features child-oriented workshops to give hands-on experience to an age group often neglected. There are sessions for the kindergarten through third-graders, and for fourth- through sev-

enth-graders. And, as an additional treat for CoCo Kids of all ages, we've invited frisky feline CoCo Cat to join us for the show. RAINBOWfest has something for everyone in the family!

If you missed the fun at our last RAINBOWfest in Princeton, why don't you make plans now to join us in Chicago? For members of the family who don't share your affinity for CoCo, there are many other attractions in the Chicago area.

The Hyatt Regency Woodfield offers special rates for RAINBOWfest. The show opens Friday evening with a session from 7 p.m. to 10 p.m. It's a daytime show Saturday — the CoCo Community Breakfast (separate tickets required) is at 8 a.m., then the exhibit hall opens promptly at 10 a.m. and runs until 6 p.m. On Sunday, the exhibit hall opens at 11 a.m. and closes at 4 p.m.

Tickets for RAINBOWfest may be obtained directly from the RAINBOW. We'll also send you a reservation form so you can get a special room rate.

The POSH way to go. You can have your travel arrangements and hotel reservations handled through RAINBOW affiliate, POSH Travel Assistance, Inc., of Louisville. For the same POSH treatment many of our exhibitors enjoy, call POSH at (502) 893-3311. All POSH services are available at no charge to RAINBOWfest attendees.

BE THERE!



FREE SEMINARS

Rick Adams
Independent Programmer
Writing Commercial Software

Cray Augsburg
RAINBOW Technical Editor
OS-9 For Absolute Beginners

Bill Bernico
Independent Programmer
Writing in BASIC

Tom DiMarco, Sr.
Gimmesoft
Floppy Drive Installation,
Operation and Maintenance

Marty Goodman, M.D.
RAINBOW Contributing Editor
CoCo Consultations

Ed Hathaway
David Barnes
Glenside CoCo Club
Organizing a CoCo Club

A. Buddy Hogan
Independent Programmer
Integrating CoCo 3 Into
Organizational Work

Donald Hutchison
RAINBOW CoCo SIG Database Manager
Introduction to RAINBOW's
CoCo SIG on Delphi

Jutta Kapfhammer
RAINBOW Managing Editor
Writing for Publication

Dale Lear
RAINBOW Contributor
Elements of Programming Games
Originality in Game Programming

Ross Litton
Howard Medical
Monitor Interfacing

Richard Parry
Cecil Houk
Speech Systems
Music and MIDI

Dale Puckett
RAINBOW Contributing Editor
Beginners Overview of OS-9
Beginners Overview of BASIC09

Logan Ward
Computer Center
Creative Uses for CoCo Max

Dick White
RAINBOW Contributing Editor
Spreadsheets for the CoCo

COCO COMMUNITY BREAKFAST

Dan Bruns — President, General Videotex Corporation

Our keynote speaker for the traditional CoCo Community Breakfast is Dan Bruns, president and chief executive officer of General Videotex Corporation (Delphi). Formerly a systems analyst for Sperry Univac, Mr. Bruns has helped Delphi grow into a major telecomputing information service and an important meeting place for the CoCo Community.

SPECIAL EVENT!

We're pleased to present The Educational Sandbox, a joint Tandy/RAINBOW effort. This is a computer workshop for RAINBOWfest kids. There will be two sessions on both Saturday and Sunday. One workshop will be for the kindergarten through third-grade set, and the other for fourth- through seventh-graders. Each workshop will last between 45 minutes and one hour, and will give the children and their parents hands-on experience in using Tandy computers and software.

RAINBOWfest - Chicago, Illinois

Dates: May 20-22, 1988
Hotel: Hyatt Regency Woodfield
Rooms: \$64 per night,
single or double
Advance Ticket Deadline: May 6, 1988

Join us at a future RAINBOWfest!

RAINBOWfest - Princeton, New Jersey

Dates: October 21-23, 1988
Hotel: Hyatt Regency Princeton
Rooms: \$88 per night,
single or double
Advance Ticket Deadline: Oct. 7, 1988

FREE T-Shirt to first five ticket orders received from each state.

First 500 ticket orders received get *The Rainbow Book of Simulations*.

YES, I'm coming to Chicago! I want to save by buying tickets now at the special advance sale price. Breakfast tickets require advance reservations.

Please send me:

_____ Three-day tickets at \$9 each total _____

_____ One-day tickets at \$7 each total _____

Circle one: Friday Saturday Sunday

_____ Saturday CoCo Breakfast
at \$12 each total _____

_____ RAINBOWfest T-shirts
at \$6 each total _____

(Advance sale-priced T-shirts
must be picked up at the door)

Handling Charge \$1 _____

TOTAL ENCLOSED _____

(U.S. Currency Only, Please)

Also send me a hotel reservation card for the
Hyatt Regency Woodfield (\$64, single or double
room).

Name _____
(please print)

Address _____

City _____ State _____

Telephone _____ ZIP _____

Company _____

Payment Enclosed, or Charge to:

VISA MasterCard American Express

Account Number _____

Exp. Date _____

Signature _____

Advance ticket deadline: May 6, 1988. Orders received less than two weeks prior to show opening will be held for you at the door. Tickets will also be available at the door at a slightly higher price. Tickets will be mailed six weeks prior to show. Children 4 and under, free; over 4, full price.

Make checks payable to: The RAINBOW. Mail to: RAINBOWfest, The Falsoft Building, 9509 U.S. Highway 42, P.O. Box 385, Prospect, KY 40059. To make reservations by phone, in Kentucky call (502) 228-4492, or outside Kentucky call (800) 847-0309.

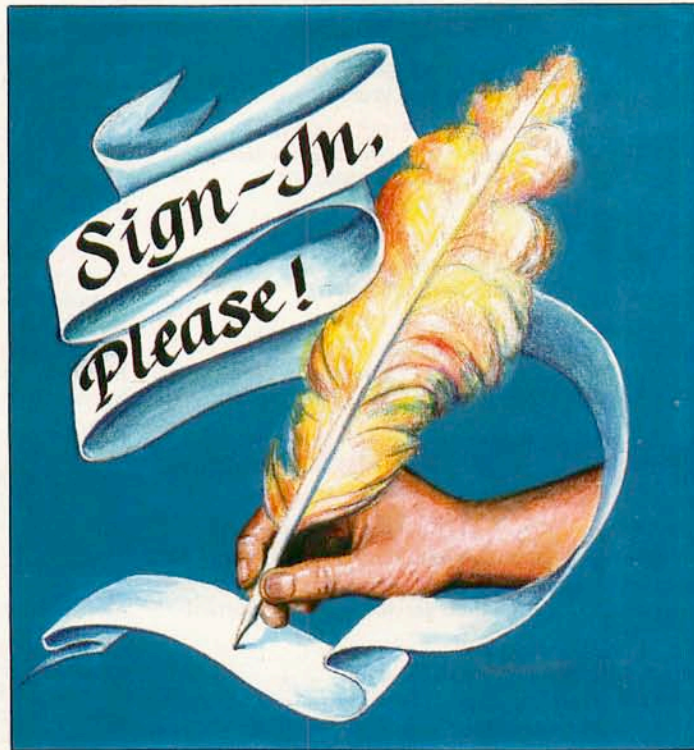

By Jim Bennett

A graphics program called *Signature* makes it possible for you to use your CoCo to create an exact rendering of your signature, logo or similar design and then print it on paper. Designs may also be saved on disk or tape for future use in personalizing stationery or business forms.

Signature is very user-friendly. It demonstrates how PMODE4 graphics can be used to tremendous advantage and how to write a screen dump routine (the part of the program that tells your printer to print your signature). REM statements in the program listing help identify the various program parts as well as indicate specific lines of importance.

The program was written for a Radio

Jim Bennett lives on the Hudson River in New York State with his wife and four children. He is deeply involved in education and owns E.Z. Friendly Software.

Shack DMP-105 printer and should also run on the newer DMP-106. The screen dump can be modified for use with any printer that prints a standard seven-dot column. If you are unsure whether or not your printer prints a seven-dot column, refer to your printer operation manual.

The program is not very long and should not be difficult to key in. Nevertheless, you should use care to avoid typing mistakes, being especially careful to type lines 570 through 600 exactly as listed. Typographical errors in these lines will very likely produce FC Errors in Line 680, which relies on correct DATA statements to make the program run properly. Unlike easy-to-locate Syntax (SN) Errors, the source of a functional error can be very difficult to track down, since it most often will show up in a line that is error-free. Also take the precaution of saving the program before you attempt to run it the first time.

When you run the program, you should see the title written in script at the very top of the screen, a horizontal rectangle that is the writing space, and underneath, a menu of five options initiated by pressing the number keys 1 through 5. From the menu you may choose to write a signature, load a previously saved signature, save the one currently displayed in the writing space, print it, or erase it and start over again.

This program's method of writing text on the graphics screen will be familiar to experienced programmers. It is widely used; however, the version presented here is as short and simple as you'll find anywhere. In Line 610 the data for drawing the text characters is put into two arrays (numbers and letters). Then whenever it is necessary to put text on the screen, the program will first define the line of text together with the horizontal and vertical coordinates showing where the text should go (T\$, H\$, V\$). Next it goes to the subroutine

in lines 640 through 690, which uses the ASCII codes of the individual numbers and letters to draw the correct characters on the screen.

If you select Option 1 from the menu, the menu quickly disappears. In its place appears an impressive diagram of the keys used for writing. The commands that draw the diagram, as well as the title script, were created using the graphics utility, *Leonardo's Pencil*. The arrows in the diagram show the eight directions that the cursor can be moved when you press the keys, giving you precise control over the movement of the cursor. Holding down the ENTER key will cause the cursor to make a mark wherever it moves, pressing U for "undo" will erase previous marks, and pressing the M key will return you to the menu. Note, however, that you do not have to return to the menu to initiate options 2 through 5.

Observe how quickly the screen changes when you go from the menu to the writing option or back to the menu again. The technique for erasing the menu portion of the screen while leaving the writing space untouched is based on the fact that the writing space at the top takes up the first page of the PMODE4 graphics screen, while the area below it occupies pages 2 through 4. In order to erase the space quickly, a copy of the blank, lower three-quarters of the screen is first PCOPYed to graphics pages 5 through 7 (Line 30). Afterwards, the program simply PCOPYs pages 5 through 7 back to pages 2 through 4 (Line 880); in the blink of an eye, the area is erased!

If you have difficulty getting the cursor to write exactly the way you want (after all, using the keys isn't quite the same as "clicking your Bic!"), you might prefer the following technique for getting an exact rendering of your signature. Use a wax marking pen to write in the space directly on your monitor screen. This will serve as a guide that can be cleaned off after you are done. With a written guide in place, you can carefully trace underneath. Practice and you can become really proficient in using the keys to move the cursor exactly where you want it to go.

During the writing routine (lines 80 through 270), the program employs two methods of monitoring the keys that are pressed. The INKEY function checks the directional control keys and the M key. Two peeks, PEEK 338 and PEEK 343, are used to check the ENTER and U keys, respectively. The difference is that the INKEY function will recognize only once

that a key has been pressed. It will not tell you if a key is being held down, nor will it recognize that more than one key is being pressed. By peeking at the locations in memory for the ENTER and U keys, it can be determined if they are being held down and also if they are being pressed simultaneously with another key.

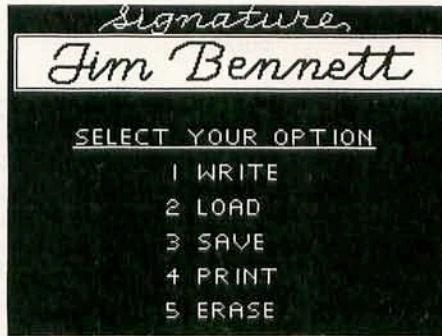

Every time a mark is made, Line 150 pokes the horizontal and vertical coordinates of the cursor position into a location in high memory that was protected by a CLEAR command at the beginning of the program. These pokes create a record of what has been written so that when you want to "undo" something, the program can peek back into the record (Line 160) and erase the previous marks. Holding the U key will "undo" until you release the key.

The LOAD and SAVE options are easy and fast, because again we take advantage of the fact that the first page of the graphics screen covers the writing space. Therefore, it is necessary only to save and load the one page. This is a noticeable timesaver, especially when you are using tape.

When you are loading or saving, it is important to have the disk or tape ready. The program will automatically recognize in Line 900 the system being used by checking the amount of available memory (the tape system has more bytes of RAM than the disk system does) and then displaying the appropriate onscreen prompt, READY DISK or READY TAPE. If you are using a tape system, you will have to delete lines 760 and 805 from the program. Also remove the apostrophes at the beginnings of lines 770 and 860. This will cause the LOAD and SAVE routines to work with tape.

When you are asked to give the name of the signature you are loading or saving, type the name slowly; it will appear in the name box on the screen (the maximum length is eight letters). If you should make a mistake in spelling, use the left arrow to backspace. When

the name is typed correctly, press ENTER and the option will execute.

Signature keeps the graphics screen in view during the entire running of the program. From the programming standpoint, it certainly would have been far easier to simply shift to the text screen during the LOAD and SAVE options. However, switching back and forth between graphics and text screens *does* give the program a really unfriendly appearance. For instance, if I had just spent a lot of effort creating a graphic and then suddenly saw it vanish before my eyes as the program changed to a text screen for the SAVE option, I would be at least a little concerned about the status of my graphic. To make things friendly (which in the case of a computer program means helpful, predictable and reassuring), routines in this program were designed to keep all the operations on the one screen.

If you select the print option, you will first be reminded to turn on the printer. Then you will be given a choice of five places, from left to right, where the signature can be printed on the paper. Once the placement is selected, the printer should begin working on the task of printing your signature.

The screen dump, contained in lines 290 through 460, is neither long nor especially complicated. Line 290 commands the printer to use condensed character and the graphics mode, to ready the print head, and to identify the last dot column on the page. Line 350 prints an appropriate number of blank spaces to position the signature properly. In lines 340 through 460 the routine uses two nested FOR-NEXT loops to scan the writing space horizontally and vertically. For each one-pixel horizontal advance, a vertical column of seven pixels is checked with the PPOINT function (lines 380 through 440).

The printer has a control code number for every one of the possible 127 combinations of dots in a column! By assigning the values of 1-2-4-8-16-32-64 to each of the seven positions, respectively, it is possible to represent all these combinations numerically. The sum of the dots in the column added to 128, the number for a blank column (no dots), will be the control code; this tells the printer the exact configuration to print. For example, CHR\$(129) tells the printer to print only one dot in the top position (128+1); CHR\$(192) tells the printer to print only one dot in the last position in the column (128+64).

Line 450 tells the printer to print a dot column duplicating the seven-pixel

column that has just been scanned. Line 460 uses a carriage return to advance to the next horizontal row.

When you look at how the screen dump works, it might appear that the printer is kept very busy printing little columns of dots on the paper one by one until the job is done. However, that is not the way the printer handles the job. Instead of printing the columns one at a time, it gathers a number of them together and prints them as a unit. So when the screen dump operates, the printer prints a section, pauses, prints another section, pauses again, and so on until the job is finished.

If you do not have a DMP-105 or DMP-106 but your printer does print a seven-dot column, it should not be too difficult to modify the screen dump to work with your printer. Simply use your printer operation manual to find out the six printer commands that are used in the screen dump routine (see Table 1). Also verify that your printer uses the same numbering system for naming the arrangement of dots in the columns. Then change the commands in the routine to fit your printer. Make absolutely certain to include all the necessary semicolons with your commands so you don't get unwanted carriage returns. Analyzing and modifying this routine should be extremely helpful in gaining

Variables			
N\$(0-9)	Numbers	V	Vertical position of cursor
L\$(0-25)	Alphabet	L	Key pressed
C	Cursor	S	Blank spaces
CC	Location where H and V are poked	L\$	Character in T\$
H\$	Horizontal location	N\$	Name of signature
V\$	Vertical location	D	Dot pattern
T\$	Line of text		
H	Horizontal position of cursor		

Printer Commands	
CHR\$(27);CHR\$(20)	Selects condensed character
CHR\$(18)	Selects graphics mode
CHR\$(27);CHR\$(16)	Ready print head
CHR\$(3);CHR\$(31)	Specifies last dot column
CHR\$(128-255)	Dot configuration in a column
PRINT#-2	Carriage return

Table 1

an understanding of the graphics capabilities of the CoCo and your printer.

As stated at the beginning, *Signature* is a good example of how to make a program very user-friendly. Perhaps you can think of ways to add your own touches to this program to make it even friendlier. Perhaps you will be inspired to create more user-friendly programs of your own. There is no such thing as

a program that can't be made friendlier, and the extra effort that is put into creating the program can take a lot of the effort out of using it.

(Questions or comments regarding this program may be directed to the author at Hutton and Orchard Sts., Rhinecliff, NY 12574. Please enclose an SASE when requesting a reply.) □

✓	12036	58049
	250113	69028
	360134	81022
	51069	END153

The listing: SIGNATUR

```

10 *****
SIGNATURE BY JIM BENNETT, 1988
*****
20 CLEAR500,22000:PCLEAR7:PMODE4
,1:PCLS0:SCREEN1,1:COLOR1:DIML$(
25),C(2,2):CC=22000:GOSUB560
30 LINE(4,17)-(251,49),PSET,B:LI
NE(6,19)-(249,47),PSET,BF:FORP=2
TO4:PCOPY TOP+3:NEXTP:GOSUB470
40 H$="40":V$="80":T$="SELECT YO
UR OPTION":GOSUB640:LINE(38,82)-
(211,82),PSET:H$="96":V$="100":T
$="1 WRITE":GOSUB640:H$="92":V$=
"120":T$="2 LOAD":GOSUB640:V$="1
40":T$="3 SAVE":GOSUB640
50 V$="160":T$="4 PRINT":GOSUB64
0:V$="180":T$="5 ERASE":GOSUB640
60 I$=INKEY$:IFI$=""ORI$<"1"ORI$
>"5"THEN60ELSEIFI$="2"THEN710ELS

```

```

EIFI$="3"THEN800ELSEIFI$="4"THEN
280ELSEIFI$="5"THENGOSUB890:GOTO
60
70 *****WRITE*****
80 GOSUB880:H$="20":V$="100":T$=
"UNDO":GOSUB640:V$="120":T$="MEN
U":GOSUB640:GOSUB500
90 H=8:V=34
100 PUT(H,V)-(H+1,V+1),C,NOT:PUT
(H,V)-(H+1,V+1),C,NOT
110 I$=INKEY$:IFI$=""THEN100
120 L=INSTR("OP@L;./",I$):IFL=0
ANDI$<>CHR$(13)ANDI$<>"M"ANDI$<>
"U"AND(I$<"2"ORI$>"5")THEN100
130 IFI$="2"THEN710ELSEIFI$="3"TH
EN800ELSEIFI$="4"THEN280ELSEIFI
$="5"THENGOSUB890:GOTO110:ELSEIF
I$="M"THENGOSUB880:GOTO40
140 ONL GOSUB200,210,220,230,240
,250,260,270
150 IFPEEK(338)<200THENCOLOR0:LI
NE(H,V)-(H+1,V+1),PSET,BF:POKECC
,H:POKECC+1,V:CC=CC+2:IFCC=32000
THENC=22000
160 IFPEEK(343)=251ANDCC>22000TH
ENCOLOR1:H=PEEK(CC-2):V=PEEK(CC-
1):LINE(H,V)-(H+1,V+1),PSET,BF:C
C=CC-2:SOUND60,2:SOUND100,2:POKE

```

```

343,255
170 IFH<6THENH=6ELSEIFH>247THENH
=247
180 IFV<19THENV=19ELSEIFV>46THEN
V=46
190 GOTO100
200 H=H-1:V=V-1:RETURN
210 V=V-1:RETURN
220 H=H+1:V=V-1:RETURN
230 H=H-1:RETURN
240 H=H+1:RETURN
250 H=H-1:V=V+1:RETURN
260 V=V+1:RETURN
270 H=H+1:V=V+1:RETURN
280 '*****PRINT SIGNATURE*****
285 GOSUB880:H$="54":V$="100":T$
="TURN ON PRINTER":GOSUB640:H$="
64":V$="120":T$="PRESS ANY KEY":
GOSUB640:EXEC44539
290 PRINT#-2,CHR$(27);CHR$(20);C
HR$(18);CHR$(27);CHR$(16);CHR$(3
);CHR$(31);:'PRINTER CODES FOR
CONDENSED CHARACTER SET, GRAPH-
ICS MODE, READY PRINT HEAD, AND
SPECIFYING LAST DOT COLUMN
300 GOSUB880:H$="16":V$="80":T$=
"SELECT POSITION ON PAPER":GOSUB
640:H$="78":V$="100":T$="1 FAR L
EFT":GOSUB640:H$="74":V$="120":T
$="2 1/3 OVER":GOSUB640:V$="140"
:T$="3 CENTER":GOSUB640
310 V$="160":T$="4 2/3 OVER":GOS
UB640:V$="180":T$="5 FAR RIGHT":
GOSUB640
320 I$=INKEY$:IFI$=""ORI$<"1"ORI
$>"5"THEN320ELSE=133*(VAL(I$)-1
):SCREEN1,1:GOSUB880:H$="26":V$=
"110":T$="NOW PRINTING SIGNATURE
":GOSUB640
330 PRINT#-2
340 FORV=19TO40STEP7
350 FORX=0TOS:PRINT#-2,CHR$(128)
;:NEXTX:'SPACING TO RIGHT
360 FORH=6TO248
370 D=128:'ADD UP DOTS IN COLUMN
380 IFPPPOINT(H,V)=0THEND=D+1
390 IFPPPOINT(H,V+1)=0THEND=D+2
400 IFPPPOINT(H,V+2)=0THEND=D+4
410 IFPPPOINT(H,V+3)=0THEND=D+8
420 IFPPPOINT(H,V+4)=0THEND=D+16
430 IFPPPOINT(H,V+5)=0THEND=D+32
440 IFPPPOINT(H,V+6)=0THEND=D+64
450 PRINT#-2,CHR$(D);
460 NEXTH:PRINT#-2:NEXTV:SCREEN1
,1:GOSUB880:GOTO40
470 '*****WRITE TITLE*****
480 DRAW "BM51,14;S4C1BR2E3RERER
ERERERUEUEUHLGDFDFDFD2G2L3H2R9
ER2EREUEUBU2UBD5DGDGDFR3ERERERUE
UERER6BL2BG3BHBL4BD3BRD2RE2REREU
ED2GDGDGDG2L5HUBR2BE6BR6RE2R3DGD

```

```

GDGBE3E3RER2FDGDGD2R4ERERE2UE2R6
BL4BG3BLBGD3RERERE2UEDGDGD2R3ERE
REREREREUEUEUEBLBG3
490 DRAW "BL3BGR12BL6BGBLBGR2D2
GDGFR4EREREREUEUBGBD3GD2R4EREREU
EU2BGBD4DFR3EREREUEUEU2BD2FR4DGD
GF2R6EREREREUEULHLGDD2D2F2R7ERER
2F2DG":RETURN
500 '*****DRAW KEYS*****
510 DRAW"BM86,75C1S4D23R27U23L27
BH2H9D7BU7R7BUBF12BDBF2BDL3G2D4F
2R2E2U4HBR29BUD19R28U23L28D4BFBR
5D8BEBU2UR3"
520 DRAW "E2UH2L4BRBE3BR4BU4U9G6
BR7BU5F4BR9BF6BR6BDBUBDD23R28U23
L27BF4BD7U5E2R4FD6GL3U4R2BRBE7BR
8BE4E9L7BF4BE3D6BLBG33BUBL38BDBG
4BLBG2BL28D24R28U23BLBG2BL19D8R
5BRBL13BDBL3L10E5BEBG6F5BR49D7R2
9U24L29D17BE7BLBU5BRBUUD7BH3LR8B
G3BDBGBD2DBD3D2G2
530 DRAW "BR7BE10BR11R10G5BE5H5B
R9D17R52U23L52D6BF2BR5D6R4BU3L3B
U3R3BR4D6BRBU6F2DF3U6BR3R7BDBL3D
5BR10L4U3R4BL4U3R4BR3D6BEBU5R2FD
2GL2BRF2RBLBG17BL21BDL30D24R30U2
3BGBL22BG2BDDUE2R2F2D2G2LD2BD2DB
D5BG2E7BDBF9BRBF2BR5BFBR2F8BUU7B

```

```

*****
*                               *****
*                               RAINBOW
*                               CERTIFICATE
*                               MAIL
*                               *****
*  !!!!!!! " ADDRESS " !!!!!!!
*
*  FINALLY THERE IS A PROGRAM THAT WILL ALLOW YOUR PRINTER
*  TO ADDRESS ENVELOPES, (all standard sizes)!!! IT WILL
*  INSTALL BOTH THE RETURN AND FORWARDING ADDRESSES ON TO
*  THE ENVELOPES AUTOMATICALLY IN ONE PASS AT THE PROPER
*  POSITIONS FOR EACH!! BESIDES THE RETURN ADDRESS THE
*  PROGRAM WILL HOLD AN ADDITIONAL 269 FORWARDING
*  ADDRESSES PER DISK!! YOU CAN MAKE BACKUP COPIES OF THIS
*  PROGRAM THEREBY HAVING THE CAPACITY OF STORING AN
*  UNLIMITED NUMBER OF ADDRESSES!! ALL ADDRESSES ARE
*  SORTED ALPHABETICALLY AND AUTOMATICALLY AS YOU ENTER
*  THEM!! THIS PROGRAM WILL SORT AND STORE ANY TYPE OF
*  INFORMATION ON DISK THEREBY IT CAN SERVE AS A DATABASE
*  WITH EXTRAORDINARY CAPABILITIES!! THIS PROGRAM IS WORTH
*  MUCH MORE THAN WE ARE ASKING BUT WE WANT IT TO BE
*  AFFORDABLE TO ALL!! DON'T MISS OUT ON A SUPER PROGRAM!!
*  Each address you file can have a total of 8 lines
*  of 64 characters each, totaling 512 characters per
*  address! Addresses will never need this much storage
*  space but other types of records may!!
*  IT WILL ALSO ADDRESS ALL STANDARD SIZES OF LABELS!!
*  FULLY DOCUMENTED WHILE RUNNING + INSTRUCTION BOOKLET!!
*  10 MENU DRIVEN ROUTINES TO FULLY AND COMPLETELY
*  MANIPULATE YOUR ADDRESS FILES SUPERBLY!!
*  SEE PRODUCT REVIEW IN THE MARCH/88 ISSUE OF RAINBOW!!
*  REQUIRES: CoCo 3; Disk Drive; Printer; Monitor OR TV!!
*  $14.95 U.S. Funds + $3.00 S/H-ONT. residents add 7% tax
*  Visa; Money order or personalized check accepted.
*  *****
*  COCO 3 WORD PROCESSOR for a DMP105 or DMP106 PRINTER
*  and DISK DRIVE. Can be used with a monitor OR TV!!!
*  Underlining, bold and all font styles + MUCH MORE!!!!
*  A SUPER WORD PROCESSOR ON A 64 COLUMN SCREEN!!!
*  Ad was composed with this word processor, "TYPE-IT"!!
*  $19.95 U.S. Funds + $3.00 S/H-ONT. residents add 7% tax
*  R.J.F. SOFTWARE; R.R. #2; WHITE LAKE, ONTARIO; KOA 3LO
*  PHONE: (613) 623-7824
*  *****

```

```

D8L8BL4ØBH7BU4U24
54Ø DRAW "L3ØD24R29BRBLBH21BL3F4
G4BD7BRDBDBF5BRBFBR2BUBD3D8E6BL6
BD6H5BL12BH7BL4U24L31D23UD2R3ØBH
2ØBUBLG5F4BD6DG2BG3BL3BG3G8U7BD7
R6BR"
55Ø RETURN
56Ø '*****TEXT CHARACTERS*****
57Ø DATA BUNFU2ERFD2GNLBR4, NU4BR
3, BU3ERFGLGDR3BR2, BU4R2FGNLFGLN2
BR3, BU2NE2R2NU2NRD2BR3, BU4NR2D2R
2FGNL2BR3, BUNFUNE2R2FGLBR4, BU4R3
G3DBR5, BRHEREHLGFRFGNLBR3, BU3NFE
RFDNLNG2BD2BR2
58Ø DATA U3ERFDNL3D2BR2, U4R2FGNL
2FGNL2BR3, BU4BR3L2GD2FR2BR2, U4R2
FD2GNL2BR3, BU4NR2D2NR2D2R2BR2, BU
4NR2D2NR2D2BR4, BU4BR3L2GD2FR2NU2
BR2, U2NU2R3NU2D2BR2
59Ø DATA BRNU4BR2, BR2BU4D3GLBR4,
U2NU2RNE2F2BR2, NU4R2BR2, U4F2NDE2
D4BR2, U4F3NU3DBR2, BUNFU2ERFD2GNL
BR3, U4R2FGNL2BD2BR3, BUNFU2ERFD2G
NLR2BR2, U4R2FGLNLF2BR2
60Ø DATA BU4BR3L2GFRFGNL2BR3, BR2
U4NL2R2BD4BR2, BUNFU3BR3D3GNLBR3,
BU2NU2F2E2NU2BD2BR2, NU4E2F2NU4BR
2, UE3BL3F3DBR2, BU4F2NE2D2BR4, BU4
R3G3DR3BR2
61Ø FORX=ØTO9:READN$(X):NEXT:FOR
X=ØTO25:READL$(X):NEXT
62Ø RETURN
63Ø '*****WRITE TEXT*****
64Ø DRAW"BM"+H$+", "+V$+"C1S8":FO
RX=1TOLEN(T$)
65Ø L$=MID$(T$,X,1):IFL$=" "THEN
DRAW"BR4":GOTO69Ø
66Ø IFL$="/"THENDRAW"NE4BR6":GOT
O69Ø
67Ø IFL$<"A"THENDRAWN$(ASC(L$)-4
8):GOTO69Ø
68Ø DRAWL$(ASC(L$)-65)
69Ø NEXTX:RETURN
70Ø '*****LOAD ROUTINE*****
71Ø GOSUB88Ø:H$="58":V$="75":T$=
"LOAD SIGNATURE":GOSUB64Ø:LINE(5
6,78)-(192,78),PSET:GOSUB9ØØ:H$=

```

```

"18":V$="12Ø":T$="TYPE AND ENTER
THE NAME":GOSUB64Ø:H$="72":N$="
":COLOR1:LINE(78,128)-(164,144),
PSET,B
72Ø I$=INKEY$:IFI$=""ORINSTR(CHR
$(13)+CHR$(8)+"123456789ØQWERTYU
IOPASDFGHJKLZXCVBNM/ ",I$)=ØTHEN
72ØELSEH$=STR$(VAL(H$)+1Ø):V$="1
4Ø":T$=I$
73Ø IFI$=CHR$(8)ANDN$<>" "THENFOR
U=1TO1Ø:DRAW"BM"+H$+", 14ØCØLNU4"
:H$=STR$(VAL(H$)-1):NEXTU:H$=STR
$(VAL(H$)-1Ø):N$=LEFT$(N$,LEN(N$
)-1):GOTO72Ø:ELSEIFI$=CHR$(8)THE
NH$=STR$(VAL(H$)-1Ø):GOTO72Ø:ELS
EIFI$=CHR$(13)THEN75Ø
74Ø IFLEN(N$)<8THENGOSUB64Ø:N$=N
$+I$:GOTO72Ø
75Ø 'LOADING
76Ø LOADMN$: 'OMIT THIS LINE IF
USING TAPE
77Ø 'CLOADMN$: 'DELETE THE FIRST
APOSTROPHE IF USING TAPE
78Ø GOSUB88Ø:GOTO4Ø
79Ø '*****SAVE ROUTINE*****
80Ø GOSUB88Ø:H$="58":V$="75":T$=
"SAVE SIGNATURE":GOSUB64Ø:LINE(5
6,78)-(192,78),PSET:GOSUB9ØØ:H$=
"18":V$="12Ø":T$="TYPE AND ENTER
THE NAME":GOSUB64Ø:H$="72":N$="
":COLOR1:LINE(78,128)-(164,144),
PSET,B
81Ø I$=INKEY$:IFI$=""ORINSTR(CHR
$(13)+CHR$(8)+"123456789ØQWERTYU
IOPASDFGHJKLZXCVBNM/ ",I$)=ØTHEN
81ØELSEH$=STR$(VAL(H$)+1Ø):V$="1
4Ø":T$=I$
82Ø IFI$=CHR$(8)ANDN$<>" "THENFOR
U=1TO1Ø:DRAW"BM"+H$+", 14ØCØLNU4"
:H$=STR$(VAL(H$)-1):NEXTU:H$=STR
$(VAL(H$)-1Ø):N$=LEFT$(N$,LEN(N$
)-1):GOTO81Ø:ELSEIFI$=CHR$(8)THE
NH$=STR$(VAL(H$)-1Ø):GOTO81Ø:ELS
EIFI$=CHR$(13)THEN84Ø
83Ø IFLEN(N$)<8THENGOSUB64Ø:N$=N
$+I$:GOTO81Ø
84Ø 'SAVING
85Ø SAVEMN$,3584,5119,3584: 'OMIT
THIS LINE IF USING TAPE
86Ø 'CSAVEMN$,1536,3Ø71,1536: '
DELETE FIRST APOSTROPHE IF USING
TAPE
87Ø GOSUB88Ø:GOTO4Ø
88Ø SOUND12Ø,1:FORP=5TO7:PCOPYP
TOP-3:NEXTP:RETURN: 'ERASE
89Ø CC=22ØØØ:COLOR1:LINE(6,19)-
(249,47),PSET,BF:RETURN: 'CLEAR
90Ø H$="78":V$="1ØØ":IFMEM<2ØØØT
HENT$="READY DISK"ELSET$="READY
TAPE"
91Ø GOSUB64Ø:RETURN

```

HALF-PRICED SOFTWARE SALE.....FROM BILL BERNICO SOFTWARE

You'll get all 7 of my 'PACK' disks for only \$21. That's over 230 programs, 50 of those are for the CoCo 3. You'll get COCOPACK, FUNPACK, VALUPACK, SUBPACK, UTILPACK and 3-PACK (Volumes 1 & 2). No additional costs for shipping. There are games, graphics, utilities, tutorial, educational, home help, disk management, font styles, printer, music and other helpful, useful and entertaining programs for your Color Computer. This is a 1-time, limited offer, so hurry! U.S. funds only. Send cash, check or money order only to: Bill Bernico Software 708 Michigan Ave. Sheboygan, WI 53081

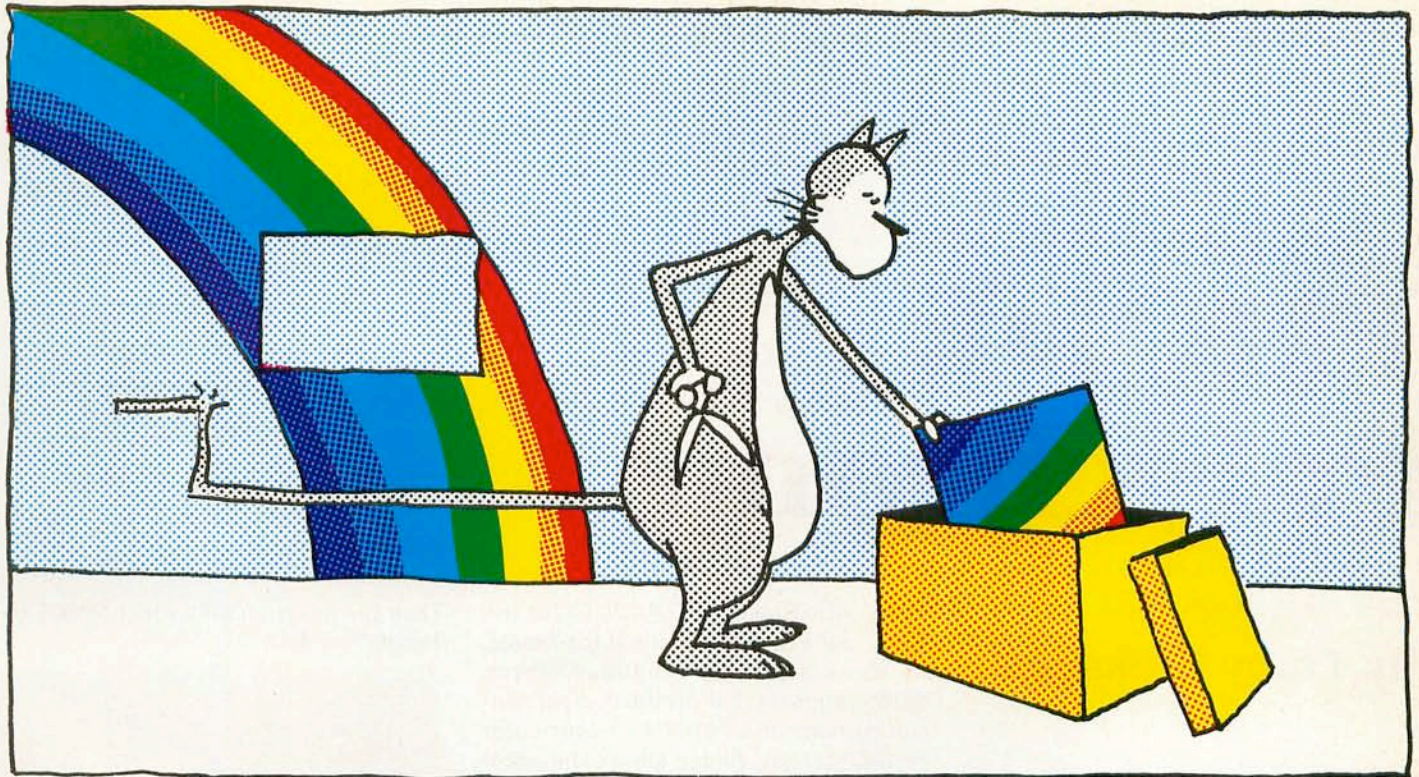

HOW DO YOU GIVE A RAINBOW?

It's simple — Give a RAINBOW gift certificate . . .

Let a gift subscription to THE RAINBOW carry the premier Color Computer magazine right to your friends' doorsteps. THE RAINBOW is *the* information source for the Tandy Color Computer.

Each month, your friends will enjoy the intelligent programs, reviews and articles written exclusively for their CoCo.

First, your gift will be announced in a handsome card. Then, all year 'round, they'll remember you and your thoughtfulness when they get each edition of THE RAINBOW — more than 200 pages loaded with as many as 24 programs, 15 regular columns and lots of helpful hints and tips.

Generosity benefits the giver, too. There'll be no more tracking down borrowed copies of THE RAINBOW. Your collection will be safe at home.

Give a RAINBOW gift certificate and let your friends in on the fun. THE RAINBOW is the perfect companion for the Color Computer!

Get your order to us by May 25 and we'll begin your friends' subscriptions with the July issue of RAINBOW.

Please begin a one-year (12 issues) gift subscription to THE RAINBOW for:

Name _____

Address _____

City _____ State _____ ZIP _____

From:

Name _____

Address _____

City _____ State _____ ZIP _____

My payment is enclosed.

Bill to: VISA MasterCard American Express
Acct. # _____ Exp. date _____

Signature _____

Mail to:

Rainbow Gift Certificate, The Falsoft Building, P.O. Box 385, Prospect, KY 40059

For credit card orders call (800) 847-0309, 8 a.m. to 5 p.m. EST.

All other inquiries call (502) 228-4492.

Subscriptions to THE RAINBOW are \$31 in the United States; U.S. \$38 in Canada. The surface rate to other countries is U.S. \$68; the air rate, U.S. \$103. Kentucky residents add 5% sales tax. **U.S. currency only, please.** All subscriptions begin with the current issue. Please allow 6 to 8 weeks for delivery. In order to hold down non-editorial costs, we do not bill.



Dump your PMODE 3 and 4 screens in color

PMODE Polychrome

By Tracy L. Skaggs

Radio Shack's CGP-220 Color Ink Jet Printer is required for *Image*, an assembly language screen dump program that produces a pseudo-color image of a PMODE4 or four-color PMODE3 screen. *Image* allows the selection of a small or enlarged image to be printed, as well as the particular color translation from screen to printer.

Before running *Image*, be sure to clear enough space for it at the top of available RAM. For 32K this is CLEAR 200,&H7B2B, and for 16K it is CLEAR 200,&H3B2B (see the end of the article for particulars on modifying *Image* for 16K). When the program is executed (&H7BF6 for 32K and &H3BF6 for 16K), the title screen appears along with the question ENLARGE?. A response of Y will result in an enlarged dump, while a response of N prints a small image.

Tracy Skaggs, a junior computer science major, is a self-taught programmer who has enjoyed his CoCo for six years. His other interests include science fiction, stargazing and biking.

Then the program asks which PMODE to dump, 3 or 4.



If PMODE 4 is selected, the program asks if you want to translate even pixels (0,2,4,6,...) or odd pixels (1,3,5,7,...) as red, and if you want, set pixels on the screen to print as white (non-printing) or black (printing). If PMODE 3 is chosen, *Image* asks you to choose the printing colors for the four possible pixel values 0, 1, 2 and 3. Any combination of the eight printer colors is valid. Following these queries, *Image* begins to dump the screen; when that is finished, the program restarts.

Although fully documented, there are

To produce 8 dots of the 8 possible colors:

Red Data	0	1	0	1	0	1	0	1
Green Data	0	0	1	1	0	0	1	1
Blue Data	0	0	0	0	1	1	1	1
Produces	B	R	G	Y	B	M	V	W
	l	e	r	e	l	a	i	h
	a	d	e	l	u	g	o	i
	c		e	l	e	e	l	t
	k		n	o		n	e	e
				w		t	t	
						a		

Figure 1

some routines that may require more in-depth explanation. *Image* has 16 major routines listed in Table 1 along with a short description of what they do. While most of these are easily understood, six of them are less straightforward.

Routines

The routines PMOD3 and PMOD4 process the graphics screen, line by line, and dump the resulting data to the printer. The method used by the CGP-220, called the color-scan mode, is fairly simple. This mode is not much different from a normal dot-addressable graphics mode. However, instead of printing the data in a vertical column of seven or eight dots, it prints an eight-dot horizontal row. Also, when the mode is selected, a value is given indicating how many of these eight-dot rows are to be printed on one line. The color of each dot is determined by RGB color mixing, so for any one line consisting of 32 eight-dot rows, the printer requires 96 bytes to be sent: 32 bytes of red data, 32 bytes of green data and 32 bytes of blue data. Refer to Figure 1 to see how the eight different colors can be attained.

PMOD3 and PMOD4 scan the screen line and examine a pixel to determine what color it should print (a pixel is a group of bits: In PMODE 3 these groups are two bits wide and in PMODE 4 they are one bit wide). PMOD3 calculates the value of the current pixel (0-3) and calls the routine COLOR that determines the proper printer color for the pixel. PMOD4 does nearly the same thing, except it keeps track of whether the pixel is odd or even and if the last bit was set or reset. This is required to reproduce the color artifacting as seen on the screen: If the current pixel is odd and the previous bit was not set, it will print as red (or blue, depending on your selection). If the previous bit was set, then this pixel will print as white (or black, depending on your selection).

The routines SETCLR and COLOR are used by PMOD3 to produce the proper color for each of four possible pixel values. SETCLR is called to select the four colors corresponding to the pixel values. COLOR is called to do the actual setting of the values in the red, green and blue color buffers. To accomplish this, a series of tables is used. The first, CTABLE, holds four bytes having the values 0-7 corresponding to the eight available colors. The values act as an offset in the second table. This table, JTABLE, is simply eight addresses pointing to the eight color routines in lines 02400-02920.

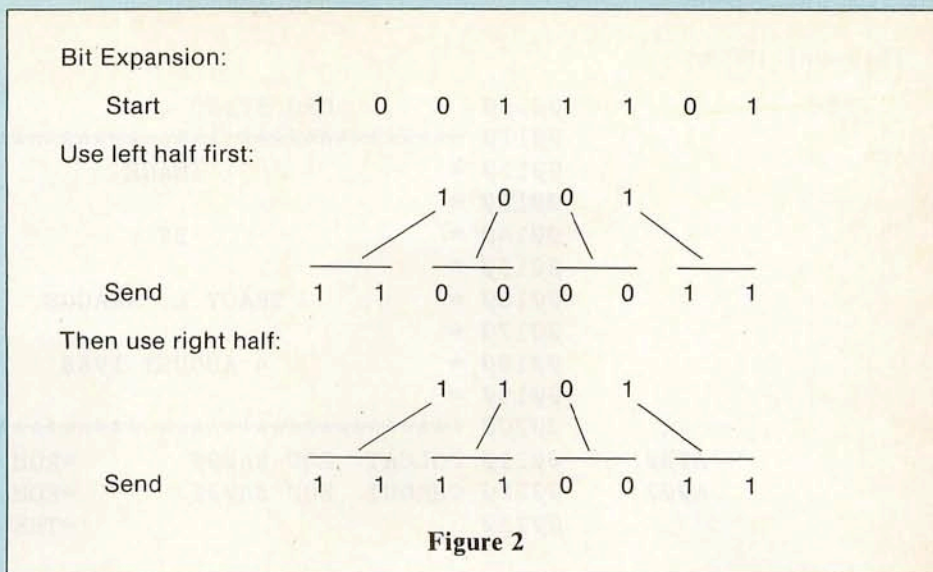

Figure 2

PSEUDO is the routine that asks what pixels, odd or even, will be printed red and whether to print set pixels as black or white. After getting a response, PSEUDO modifies PMOD4 in two places. MODIF1 and MODIF2 are given the address of the routine for black or white, and MODIFY is toggled between BEQ (if even is to be red) and BNE (if odd is to be red). Note that the artifact color blue is printed as violet in Line 01540. This is because the violet ink looks more like the artifact blue than the blue ink does. If you don't agree, change it.

Finally, ENLARG modifies the color data so that as it is sent to the printer, each separate bit is expanded into two bits. The method used here may not be the most eloquent, but it is the first one that worked. The routine expands first the left and then the right half of the byte. After each half is expanded, it is sent to the printer. See Figure 2.

Modifications

The assembly listing is shown assembled by Radio Shack's EDTASM+ (as patched for disk in THE RAINBOW by Roger Schrag) for a 32K Disk ECB CoCo. However, to assemble it for 16K simply change the origination address at Line 00100 from \$7B8C to \$3B8C. If you do not have a disk system, you must change the start and end addresses for the graphics screen. These are in lines 00330 and 00340 and should be changed to \$0600 and \$1E00, respectively. To print graphics from another location, you can modify these addresses to point wherever you want.

(Questions or comments regarding this program may be directed to the author at 1815 East 5th St., Milan, IL 61264. Please enclose an SASE when requesting a reply.)

Table 1

START	Initializes baud rate (1=9600, 6=4800, 18=2400, 41=1200, 87=600, 180=300), screen output, and clears the screen.
TPAGE	Asks opening questions.
PMOD3	Dumps a PMODE 3 screen.
COLOR PMOD4	Selects proper color. Dumps a PMODE 4 screen.
SETX	Points X to the current byte in the color buffers.
POWERS	Generates the powers of 2 for bit manipulation.
BLACK, WHITE, RED, GREEN, BLUE, YELLOW, MAGENTA, VIOLET	Color routines.
SETCLR	Asks how to translate colors to the printer.
DUMPO	Dumps the color buffers to the printer.
ENLARG	Enlarges bytes being sent to the printer if requested.
CLEARO	Clears the contents of the color buffers of old data.
GRAFIX	Sends setup values to the printer for color scan mode.
PRINT	Prints a message beginning at X on the screen.
GETKEY	Gets a response from the keyboard, loops indefinitely until a response is given. □

The listing: IMAGE

```

7B8C          00100          ORG $7B8C
00110 *****
00120 *          IMAGE          *
00130 *          *
00140 *          BY          *
00150 *          *
00160 *          TRACY L. SKAGGS          *
00170 *          *
00180 *          4 AUGUST 1986          *
00190 *          *
00200 *****
A000          00210 POLCAT EQU $A000          *ROM ROUTINE TO POLE KEYBOARD
A002          00220 CHROUT EQU $A002          *ROM ROUTINE TO SEND REG. A TO
00230          00230          *THE DEVICE IN 'DEVNUM' ($006F)

7B8C          00240 RBUF          RMB 32          *RED DATA BUFFER
7BAC          00250 GBUF          RMB 32          *GREEN DATA BUFFER
7BCC          00260 BBUF          RMB 32          *BLUE DATA BUFFER
7BEC          00          00270 ODEV          FCB 0          *SET FOR ODD PIXEL, RESET FOR E
VEN
7BED          00          00280 SETFLG          FCB 0          *SET IF LAST BIT WAS SET
7BEE          00          00290 VALUE          FCB 0          *VARIOUS
7BEF          00          00300 ENLRG          FCB 0          *IF SET, ENLARG PICTURE
7BF0          00          00310 BIT          FCB 0          *CURRENT BIT (0-7)
7BF1          00          00320 BYTE          FCB 0          *CURRENT BYTE (0-31)
7BF2          0E00          00330 PAGEST          FDB $0E00          *GRAPHICS PAGE START
7BF4          2600          00340 PAGEND          FDB $2600          *GRAPHICS PAGE END
7BF6 86 12          00350 START          LDA #18          *SET PRINTER OUTPUT
7BF8 97 96          00360          STA <$96          *TO 2400 BAUD
7BFA 0F 6F          00370          CLR <$6F          *SCREEN OUTPUT
7BFC BD A928          00380          JSR $A928          *CLEAR SCREEN
7BFF 8E 7EAF          00390 TPAGE          LDX #TITLE          *GET TITLE MESSAGE
7C02 BD 7E9D          00400          JSR PRINT          *PRINT IT
7C05 8E 04E0          00410 QUERY          LDX #$04E0          *SET CURSOR POSITION
7C08 9F 88          00420          STX <$88          *FOR ENLARGE QUERY
7C0A 8E 7F1E          00430          LDX #QUERY1          *GET MESSAGE
7C0D BD 7E9D          00440          JSR PRINT          *PRINT IT
7C10 BD 7EA8          00450          JSR GETKEY          *WAIT FOR A RESPONSE
7C13 81 59          00460          CMPA #'Y          *WAS IT 'Y'
7C15 26 0A          00470          BNE NO          *NO, BRANCH
7C17 B7 7BEF          00480          STA ENLRG          *YES, SET FLAG
7C1A 86 40          00490          LDA #64          *AND SEND 64 ROWS IN GRAFIX SET
UP
7C1C B7 7FEA          00500          STA PTABLE+2          *TO PRINTER
7C1F 20 0C          00510          BRA QURY1          *BRANCH TO PMODE QUERY
7C21 81 4E          00520 NO          CMPA #'N          *WAS IT 'N'?
7C23 26 E0          00530          BNE QUERY          *NO, TRY AGAIN
7C25 86 20          00540          LDA #32          *YES, SEND 32 ROWS IN GRAFIX SE
T UP
7C27 B7 7FEA          00550          STA PTABLE+2          *TO PRINTER
7C2A 7F 7BEF          00560          CLR ENLRG          *RESET FLAG
7C2D 8E 04F0          00570 QURY1          LDX #$04F0          *SET CURSOR POSITION FOR PMODE
7C30 9F 88          00580          STX <$88          *QUERY.
7C32 8E 7F28          00590          LDX #QUERY2          *GET MESSAGE
7C35 BD 7E9D          00600          JSR PRINT          *PRINT IT
7C38 BD 7EA8          00610 GET2          JSR GETKEY          *WAIT FOR A RESPONSE

```

7C3B 81	33	ØØ62Ø	CMPA #'3	*WAS IT '3'?
7C3D 27	Ø6	ØØ63Ø	BEQ PMOD3	*YES, DUMP A PMODE 3 SCREEN.
7C3F 81	34	ØØ64Ø	CMPA #'4	*WAS IT '4'?
7C41 26	F5	ØØ65Ø	BNE GET2	*NO, TRY AGAIN
7C43 2Ø	6E	ØØ66Ø	BRA PMOD4	*YES, DUMP A PMODE 4 SCREEN.
		ØØ67Ø *		
		ØØ68Ø	*ROUTINE TO DUMP PMODE 3	
		ØØ69Ø	*COLOUR OUTPUT IS DETERMINED BY USER	
		ØØ7ØØ	*CHOICE IN 'SETCLR'.	
		ØØ71Ø *		
7C45 BD	7DE3	ØØ72Ø	PMOD3 JSR SETCLR	*GET COLOUR CHOICES
7C48 17	Ø238	ØØ73Ø	LBSR CLEARØ	*CLEAR DATA BUFFERS
7C4B 7F	7BF1	ØØ74Ø	CLR BYTE	*CLEAR BYTE COUNT
7C4E 1ØBE	7BF2	ØØ75Ø	LDY PAGEST	*START OF GRAFIX SCREEN
7C52 A6	AØ	ØØ76Ø	NEXTBT LDA ,Y+	*GET NEXT BYTE OFF SCREEN
7C54 7F	7BFØ	ØØ77Ø	CLR BIT	*CLEAR BIT COUNT
7C57 7F	7BEE	ØØ78Ø	ROLLIT CLR VALUE	*CLEAR OUT 'VALUE'. WILL HOLD
		ØØ79Ø		*VALUE OF TWO BIT PIXEL
7C5A 48		ØØ8ØØ	LSLA	*SHIFT FIRST BIT OFF A INTO CAR
RY				
7C5B 79	7BEE	ØØ81Ø	ROL VALUE	*ROLL IT INTO 'VALUE'
7C5E 48		ØØ82Ø	LSLA	*SHIFT THE SECOND
7C5F 79	7BEE	ØØ83Ø	ROL VALUE	*ROLL INTO 'VALUE'
7C62 8D	2E	ØØ84Ø	BSR COLOUR	*GO SET CORRESPONDING COLOUR
7C64 7C	7BFØ	ØØ85Ø	INC BIT	*ADD 1 TO BIT COUNT
7C67 F6	7BFØ	ØØ86Ø	LDB BIT	*CHECK COUNT
7C6A C1	Ø8	ØØ87Ø	CMPB #8	*LAST FOR THIS BYTE?
7C6C 25	E9	ØØ88Ø	BLO ROLLIT	*NO, LOOP TO ROLL AGAIN

TURBO RAM BOARD



\$39.95
ZERO K

\$119.95
512 K

- Fast 120 nsec RAM chips
- Easy-to-follow instructions
- No soldering
- Includes RAM Board Utilities

PYRAMIX Arcade Game \$19.95

BACKUP LIGHTNING (disk duplicator) \$14.95

RAM BOARD UTILITIES

- RAM Disk for RSDOS
- Print Spooler
- Sophisticated MEMORY TEST Program

\$19.95

PAL UPGRADE

\$7.95

for grey or white
MULTI-PACK (26-3024)

DUAL-MODE CONTROLLER



\$99.95*

*ROM not included (RS DOS
1.1 ROM—\$19.95). 32K
SRAM—\$16.95.

- 100% Compatible with existing H/W & S/W
- No MULTI-PACK required (low power draw)
- 8K Cache memory (expandable to 32K)
- Track Reads (programs load up to 2x faster)
- Two Switched Sockets (supports 8K ROM, 2764/27128/27256 EPROMs)
- Gold Contacts for reliability
- Easy Installation (no cutting, soldering, jumpers or external wires)
- Runs under OS-9 with:
 - no-halt read/write
 - interrupts and multi-tasking enabled
 - reliable clock and type-ahead

S&H: \$3.50 U.S. and Canada (\$15 foreign)
COD: \$2.25 U.S. only
2ND Day Air: \$1.50 (contiguous U.S. only)
Tax: inside California add 6%
VISA or MC accepted

**30 DAY MONEY-BACK
GUARANTEE PLUS FULL 1 YEAR
WARRANTY ON ALL PRODUCTS!**

Prices subject to change without notice

Send check or money-order to:

**Performance
peripherals**
11432 Pena Way
Mira Loma, CA 91752
Or Call (714) 681-3007

7C6E	7C	7BF1	00890	INC BYTE	*YES, ADD 1 TO BYTE COUNT
7C71	F6	7BF1	00900	LDB BYTE	*CHECK COUNT
7C74	C1	20	00910	CMPB #S20	*LAST BYTE IN ROW?
7C76	25	DA	00920	BLO NEXTBT	*NO, GET NEXT BYTE
7C78	7F	7BF1	00930	CLR BYTE	*YES, CLEAR BYTE COUNT
7C7B	7D	7BEF	00940	TST ENLRG	*TEST FOR LARGE PICTURE
7C7E	27	03	00950	BEQ WUNS	*IF NOT, SEND BUFFER ONCE
7C80	17	01AB	00960	LBSR DUMP0	*OTHERWISE SEND IT TWICE
7C83	17	01A8	00970 WUNS	LBSR DUMP0	*
7C86	17	01FA	00980	LBSR CLEAR0	*CLEAR DATA BUFFERS
7C89	10BC	7BF4	00990	CMPI PAGEND	*END OF SCREEN?
7C8D	25	C3	01000	BLO NEXTBT	*NO, GET NEXT BYTE.
7C8F	16	FF64	01010	LBRA START	*YES, RESTART.
			01020 *		
			01030	*ROUTINE TO SET PROPER	
			01040	*COLOUR FROM 'VALUE' BASED	
			01050	*ON SELECTION TABLE.	
			01060 *		
7C92	34	22	01070 COLOUR	PSHS Y,A	*SAVE REGISTERS
7C94	F6	7BEE	01080	LDB VALUE	*GET PIXEL VALUE (0-3)
7C97	8E	7FEC	01090	LDX #CTABLE	*GET SELECTION TABLE ADDRESS
7C9A	3A		01100	ABX	*ADD B'S OFFSET INTO IT
7C9B	E6	84	01110	LDB ,X	*GET COLOUR NUMBER SELECTED
7C9D	8E	7FF0	01120	LDX #JTABLE	*POINT TO JUMP TABLE
7CA0	86	02	01130	LDA #2	*EACH ADDRESS IN TABLE
			01140		*IS TWO BYTES LONG.
7CA2	3D		01150	MUL	*MULTIPLY COLOUR # BY 2.
7CA3	3A		01160	ABX	*ADD THAT OFFSET INTO X.
7CA4	1F	12	01170	TFR X,Y	*X POINTS INDIRECTLY TO COLOUR
			01180		*SO PUT IT IN Y AND
7CA6	17	00E8	01190	LBSR SETX	*GO POINT X TO BUFFER BYTE
7CA9	AD	B4	01200	JSR [,Y]	*JUMP INDIRECTLY TO SET COLOUR.
7CAB	7C	7BF0	01210	INC BIT	*PIXELS ARE TWO BITS LONG SO
7CAE	AD	B4	01220	JSR [,Y]	*DO THE NEXT ONE TOO.
7CB0	35	22	01230	PULS Y,A	*RECOVER REGISTERS AND
7CB2	39		01240	RTS	*RETURN.
			01250 *		
			01260	*ROUTINE TO DUMP PMODE 4	
			01270	*WITH PSEUDO COLOURS.	
			01280 *		
7CB3	8D	7C	01290 PMOD4	BSR PSEUDO	*SELECT EVEN OR ODD PIXELS RED
7CB5	17	01CB	01300	LBSR CLEAR0	*CLEAR BUFFERS
7CB8	7F	7BEC	01310	CLR ODEV	*RESET ODD/EVEN FLAG
7CBB	7F	7BED	01320	CLR SETFLG	*RESET LAST BIT FLAG
7CBE	7F	7BF1	01330	CLR BYTE	*CLEAR BYTE COUNTER
7CC1	10BE	7BF2	01340	LDY PAGEST	*START OF GRAFIX PAGE
7CC5	A6	A0	01350 NXTBYT	LDA ,Y+	*GET NEXT BYTE OFF SCREEN
7CC7	7F	7BF0	01360	CLR BIT	*CLEAR BIT COUNTER
7CCA	49		01370 ROLBIT	ROLA	*ROLL BIT OFF A INTO CARRY
7CCB	25	0B	01380	BOS NEXT	*BRANCH IF BIT WAS SET
7CCD	17	00C1	01390	LBSR SETX	*OTHERWISE POINT X INTO BUFFER
7CD0		BD	01400	FCB \$BD	*OP CODE FOR 'JSR'
7CD1		0000	01410 MODIF1	FDB \$0000	*ADDRESS OF BLACK/WHITE ROUTINE
7CD3	7F	7BED	01420	CLR SETFLG	*CLEAR BIT FLAG

7CD6	20	23	01430	BRA LOOP	*GO FINISH PASS
7CD8	7D	7BED	01440 NEXT	TST SETFLG	*TEST LAST BIT FLAG
7CDB	27	08	01450	BEQ NEXT1	*BRANCH IF BIT WAS ZERO
7CDD	17	00B1	01460	LBSR SETX	*OTHERWISE GO POINT X INTO BUFF
ER					
7CE0		BD	01470	FCB \$BD	*OP CODE FOR 'JSR'
7CE1		0000	01480 MODIF2	FDB \$0000	*ADDRESS OF BLACK/WHITE ROUTINE
7CE3	20	16	01490	BRA LOOP	*FINISH PASS
7CE5	7C	7BED	01500 NEXT1	INC SETFLG	*BIT WAS SET, SO SET THE FLAG
7CE8	7D	7BEC	01510	TST ODEV	*TEST FOR ODD OR EVEN PIXEL
7CEB	27	08	01520 MODIFY	BEQ NEXT2	*BRACH IF EVEN (RESET)
7CED	17	00A1	01530	LBSR SETX	*OTHERWISE POINT X INTO BUFFER
7CF0	17	00EB	01540	LBSR VIOLET	*AND SET BIT TO VIOLET
7CF3	20	06	01550	BRA LOOP	*FINISH PASS
7CF5	17	0099	01560 NEXT2	LBSR SETX	*GO POINT X INTO BUFFER
7CF8	17	00B7	01570	LBSR RED	*AND SET BIT TO RED.
7CFB	F6	7BEC	01580 LOOP	LDB ODEV	*TOGGLE ODD/EVEN FLAG
7CFE	C8	01	01590	EORB #1	*
7D00	F7	7BEC	01600	STB ODEV	*
7D03	7C	7BF0	01610	INC BIT	*ADD 1 TO BIT COUNT
7D06	F6	7BF0	01620	LDB BIT	*CHECK COUNT
7D09	C1	08	01630	CMPB #8	*ARE WE FINISHED?
7D0B	25	BD	01640	BLO ROLBIT	*NO, GO ROLL ANOTHER BIT
7D0D	7C	7BF1	01650	INC BYTE	*YES, ADD 1 TO BYTE COUNT
7D10	F6	7BF1	01660	LDB BYTE	*CHECK COUNT
7D13	C1	20	01670	CMPB #\$20	*ARE WE DONE WITH THIS LINE?
7D15	25	AE	01680	BLO NXTBYT	*NO, GO GET ANOTHER BYTE
7D17	7F	7BF1	01690	CLR BYTE	*YES, CLEAR BYTE COUNT
7D1A	7D	7BEF	01700	TST ENLRG	*SENDING A LARGE PICTURE?
7D1D	27	03	01710	BEQ ONCE	*NO, SEND DATA ONCE
7D1F	17	010C	01720	LBSR DUMP0	*OTHERWISE SEND IT TWICE
7D22	17	0109	01730 ONCE	LBSR DUMP0	*
7D25	17	015B	01740	LBSR CLEAR0	*SEND DATA BUFFER
7D28	10BC	7BF4	01750	CMPY PAGEND	*DONE WITH SCREEN?
7D2C	25	97	01760	BLO NXTBYT	*NO, GO GET NEXT BYTE
7D2E	16	FEC5	01770	LBRA START	*YES, RESTART PROGRAMME.
			01780 *		
			01790	*ROUTINE TO SELECT PSEUDO	
			01800	*COLOUR OUTPUT.	
			01810 *		
7D31	8E	04E0	01820 PSEUDO	LDX #\$04E0	*CLEAR FROM X
7D34	CC	6060	01830	LDD #\$6060	*TO BOTTOM OF SCREEN
7D37	ED	81	01840 PSEUD1	STD ,X++	
7D39	8C	0600	01850	CMPX #\$0600	
7D3C	25	F9	01860	BLO PSEUD1	
7D3E	8E	0500	01870	LDX #\$500	*POINT X TO PSEUDO COLOUR MESSA
GE					
7D41	9F	88	01880	STX <\$88	
7D43	8E	7FB2	01890	LDX #PMESS	*POINT X TO MESSAGE
7D46	BD	7E9D	01900	JSR PRINT	*PRINT IT
7D49	BD	7EA8	01910 PSEUD2	JSR GETKEY	*GET RESPONSE
7D4C	81	45	01920	CMPA #'E	*WAS IT AN 'E'?
7D4E	27	0B	01930	BEQ PSEUD3	*BRANCH IF YES
7D50	81	4F	01940	CMPA #'O	*WAS IT AN 'O'?
7D52	26	F5	01950	BNE PSEUD2	*NO, TRY AGAIN
7D54	86	26	01960	LDA #\$26	*YES, OP CODE FOR 'BNE'

7D56	B7	7CEB	01970	STA	MODIFY	*
7D59	20	05	01980	BRA	PSOUT	*BRANCH OUT
7D5B	86	27	01990	PSEUD3	LDA #S27	*'BEQ' OP CODE
7D5D	B7	7CEB	02000	STA	MODIFY	*
7D60	8E	0520	02010	PSOUT	LDX #S520	*POINT X TO SCREEN POSITION
7D63	9F	88	02020	STX	<S88	*FOR BLACK/WHITE QUERY
7D65	8E	7FC7	02030	LDX	#BLKWHT	*GET MESSAGE ADDRESS
7D68	BD	7E9D	02040	JSR	PRINT	*PRINT IT
7D6B	BD	7EA8	02050	CHKKEY	JSR GETKEY	*WAIT FOR RESPONSE
7D6E	81	42	02060	CMPA	#'B	*IS IT 'B'LACK?
7D70	26	0E	02070	BNE	CHKWHT	*NO, CHECK FOR 'W'
7D72	8E	7DAA	02080	LDX	#BLACK	*YES, GET BLACK ROUTINE ADDRESS
7D75	BF	7CE1	02090	STX	MODIF2	*MODIFY JUMP OPERAND
7D78	8E	7DAB	02100	LDX	#WHITE	*GET WHITE ROUTINE ADDRESS
7D7B	BF	7CD1	02110	STX	MODIF1	*MODIFY OTHER JUMP OPERAND
7D7E	20	10	02120	BRA	PSOUT2	*BRANCH OUT
7D80	81	57	02130	CHKWHT	CMPA #'W	*IS IT 'W'HITE?
7D82	26	E7	02140	BNE	CHKKEY	*NO, TRY AGAIN
7D84	8E	7DAB	02150	LDX	#WHITE	*YES, GET WHITE ROUTINE ADDRESS
7D87	BF	7CE1	02160	STX	MODIF2	*MODIFY JUMP OPERAND
7D8A	8E	7DAA	02170	LDX	#BLACK	*GET BLACK ROUTINE ADDRESS
7D8D	BF	7CD1	02180	STX	MODIF1	*MODIFY OTHER JUMP OPERAND
7D90	39		02190	PSOUT2	RTS	
			02200	*		
			02210	*	ROUTINE TO POINT X INTO	
			02220	*	GRAFIX DATA BUFFER	
			02230	*		
7D91	8E	7B8C	02240	SETX	LDX #RBUF	*X AT BEGINNING OF BUFFER
7D94	F6	7BF1	02250	LDB	BYTE	*GET BYTE COUNT OFFSET
7D97	3A		02260	ABX		*ADD OFFSET IN
7D98	39		02270	RTS		*AND RETURN
			02280	*		
			02290	*	ROUTINE TO CALCULATE THE	
			02300	*	POWERS OF 2 FROM BIT COUNT	
			02310	*		
7D99	C6	80	02320	POWERS	LDB #128	*START 'VALUE' AT 2^7
7D9B	F7	7BEE	02330	STB	VALUE	*AND GET
7D9E	F6	7BF0	02340	LDB	BIT	*THE BIT COUNT
7DA1	27	06	02350	POLOOP	BEQ POWOUT	*IF ZERO, BRANCH OUT
7DA3	74	7BEE	02360	LSR	VALUE	*SHIFT POWER RIGHT
7DA6	5A		02370	DECB		*DECREMENT COUNT
7DA7	20	F8	02380	BRA	POLOOP	*BRANCH THROUGH LOOP
7DA9	39		02390	POWOUT	RTS	*RETURN
			02400	*		
			02410	*	SET BIT TO PRINT BLACK	
			02420	*		
7DAA	39		02430	BLACK	RTS	*Does naught. Kept for uniformity
			02440	*		
			02450	*	SET BIT TO PRINT WHITE	
			02460	*		
7DAB	8D	05	02470	WHITE	BSR RED	
7DAD	8D	0D	02480		BSR GREEN	
7DAF	8D	17	02490		BSR BLUE	
7DB1	39		02500		RTS	

			Ø251Ø *		
			Ø252Ø *SET BIT TO PRINT RED		
			Ø253Ø *		
7DB2	8D	E5	Ø254Ø RED	BSR POWERS	
7DB4	E6	84	Ø255Ø	LDB ,X	
7DB6	FA	7BEE	Ø256Ø	ORB VALUE	
7DB9	E7	84	Ø257Ø	STB ,X	
7DBB	39		Ø258Ø	RTS	
			Ø259Ø *		
			Ø26ØØ *SET BIT TO PRINT GREEN		
			Ø261Ø *		
7DBC	8D	DB	Ø262Ø GREEN	BSR POWERS	
7DBE	E6	88 2Ø	Ø263Ø	LDB 32 ,X	
7DC1	FA	7BEE	Ø264Ø	ORB VALUE	
7DC4	E7	88 2Ø	Ø265Ø	STB 32 ,X	
7DC7	39		Ø266Ø	RTS	
			Ø267Ø *		
			Ø268Ø *SET BIT TO PRINT BLUE		
			Ø269Ø *		
7DC8	8D	CF	Ø27ØØ BLUE	BSR POWERS	
7DCA	E6	88 4Ø	Ø271Ø	LDB 64 ,X	
7DCD	FA	7BEE	Ø272Ø	ORB VALUE	
7DDØ	E7	88 4Ø	Ø273Ø	STB 64 ,X	
7DD3	39		Ø274Ø	RTS	
			Ø275Ø *		
			Ø276Ø *SET BIT TO PRINT YELLOW		
			Ø277Ø *		
7DD4	8D	DC	Ø278Ø YELLOW	BSR RED	
7DD6	8D	E4	Ø279Ø	BSR GREEN	
7DD8	39		Ø28ØØ	RTS	
			Ø281Ø *		
			Ø282Ø *SET BIT TO PRINT MAGENTA		
			Ø283Ø *		
7DD9	8D	D7	Ø284Ø MAGENT	BSR RED	
7ddb	8D	EB	Ø285Ø	BSR BLUE	
7DDD	39		Ø286Ø	RTS	
			Ø287Ø *		
			Ø288Ø *SET BIT TO PRINT VIOLET		
			Ø289Ø *		
7DDE	8D	DC	Ø29ØØ VIOLET	BSR GREEN	
7DEØ	8D	E6	Ø291Ø	BSR BLUE	
7DE2	39		Ø292Ø	RTS	
			Ø293Ø *		
			Ø294Ø *CHOOSE 4-COLOUR-SET FROM		
			Ø295Ø *FROM 8 POSSIBLE PRINTER		
			Ø296Ø *COLOURS.		
			Ø297Ø *		
7DE3	8E	Ø4EØ	Ø298Ø SETCLR	LDX #Ø4EØ	*SET CURSOR PRINT POSITION
7DE6	CC	6Ø6Ø	Ø299Ø	LDD #Ø6Ø6Ø	*CLEAR SCREEN FROM THERE
7DE9	ED	81	Ø3ØØØ CLS	STD ,X++	*
7DEB	8C	Ø6ØØ	Ø3Ø1Ø	CMPX #Ø6ØØØ	*END OF SCREEN?
7DEE	25	F9	Ø3Ø2Ø	BLO CLS	*NO, LOOP BACK
7DFØ	8E	Ø4EØ	Ø3Ø3Ø	LDX #Ø4EØ	*YES, SET CURSOR POSITION
7DF3	9F	88	Ø3Ø4Ø	STX <Ø88	*FOR COLOUR OPTIONS
7DF5	8E	7F3Ø	Ø3Ø5Ø	LDX #CMESS	*GET MESSAGE LOCATION
7DF8	BD	7E9D	Ø3Ø6Ø	JSR PRINT	*PRINT IT
7DFB	8E	Ø58Ø	Ø3Ø7Ø	LDX #Ø58Ø	*SET CURSOR POSITION FOR

Save \$200 on Magnavox Monitors Magnavox 8CM643 RGB Analog only \$385!!

MONITORS

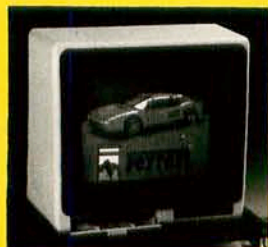

MAGNAVOX 7622

12" Amber Screen offers 900 dots x 350 lines resolution at 20 MHz on a dark glass anti-glare CRT with built-in audio and 1 year warranty.

(\$7 shipping)

\$88

MAGNAVOX 8 CM 515

has analog RGB for CoCo 3, TTL RGB for Tandy 1000 or IBM PC's, and composite color for CoCo 2 and 3. Built-in speaker. 14" screen with 640 dot x 240 line resolution. Plus 2 years parts and labor warranty.

reg. list \$499

SAVE
\$200

\$298

+ \$14 Shipping



CC-3 Magnavox RGB cable.

only **\$19.95** with
Magnavox Monitor order.
\$29.95 w/o monitor.

123A

REPEAT OF A SELL-OUT

We closed out Zenith's line of 123A 12" Green Screen Monitors with 640 x 240 resolution one year ago. Now with a special purchase we offer them one more time. This monitor offers 80 column resolution at 15 MHz.

\$67.50 (\$7 Shipping)

VA-1 for monochrome monitors only, fits all color computers

\$24.45 (\$2 Shipping)

MAGNAVOX

CM 8505 has analog RGB and TTL RGB and composite color input. Built in speaker. 13" screen with 390 dots x 240 resolution in RGB mode. Plus 1 year parts & labor warranty.

reg. list \$299

SAVE
\$79

\$220

+ \$14 Shipping



DISTO

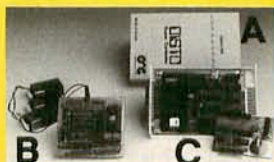

ADD-ON BOARDS

DC-38 includes 80 column capacity, parallel printer, real time clock, and all software **\$138**

DC-3P Mini Epron programmer includes all software to program 2764 or 27128 chips **\$55**

DC-3C Clock Calendar and parallel printer port **\$40**

Includes controller and C-DOS 4.0 ROM Chip. **DISTO**

\$98 DC-3 A

\$2 shipping on all DISTO products

NEW FROM DISTO

Super Controller II works with CoCo 1, 2 & 3. It buffers keyboard input so that no keystrokes are lost when disk is reading or writing. Especially useful with OS-9, but also works with BASIC.

\$129 DC6 (\$2 Shipping)

C-DOS 3 28 pin Eprom makes Disto controller compatible with CoCo 3 **\$20**

SOFTWARE SPECIALS

Payrol/BAS™ (\$2 shipping)

- Nonprotected basic is modifiable
- Tax tables built in for automatic federal calculation
- Custom code for each state (\$25 option)
- 4 pay periods
- 7 deductions
- Prints checks
- 100 employees
- 30 ledger numbers for checks other than payroll
- Check register includes monthly or weekly federal deposit amount
- Enter, update, delete employees, company and check information
- Print payroll and nonpayroll checks

Payrol/BAS™ 30 Day Trial

\$29.95

VIP LIBRARY

Softlaw's integrated package includes VIP Writer Terminal Data Base, Calc and Disk Zap which can fix a diskette that is giving I/O errors **\$125** reg. \$149 (\$2 Shipping)

VIPwriter **\$68**

DRIVE 0 + . Howards Drive 0 gives you a DD-3 MPI drive, a CA-1 cable and a J&M DC-4 Disk Controller for only. Double sided double density 360K

\$178.45

(\$5 shipping)

Add \$34 for a Disto DC-3.

Double sided
Double density
360K



20 MEG HARD DRIVE

- pre-installed, formatted and ready to run
- equivalent to 125 R.S. 501's on line
- includes Western Digital WD1002-WX1 Controller
- and Seagate 20 Meg Hard Drive
- will also work with Tandy, IBM & clones
- complete package includes 20 meg drive, case & power supply, controller and interface that plugs into slot #3 of multipack interface.
- 1 year warranty

\$699

\$499 (\$9 Shipping)

BASIC driver lets you access this hard drive without need for OS-9 \$49.95

MEMORY

64-2 for CoCo 2. Kit requires one solder point, no trace cuts.

(\$2 shipping) **\$24.45**

64-E1 for E Boards with complete instructions. Remove old chips and replace with preassembled package — no soldering or trace cuts.

(\$2 shipping) **\$28.45**

64-F1 for F Boards. No soldering needed. Capacitor leads must be cut.

(\$2 shipping) **\$24.45**

64-22 Two chip set for 26-3134A and B, 26-3136A and B. Koren Color Computers require 1 solder point.

(\$2 shipping) **\$28.45**

GUARANTEE

Howard Medical's 30-day guarantee is meant to eliminate the uncertainty of dealing with a company through the mail. Once you receive our hardware, try it out; test it for compatibility. If you're not happy with it for any reason, return it in 30 days and we'll give you your money back (less shipping).

Shipping charges are for 48 states.

APO, Canada and Puerto Rico orders are higher.

Howard Medical Computers 1690 N. Elston Chicago, IL 60622



ORDERS

(800) 443-1444

INQUIRIES AND ORDER STATUS

(312) 278-1440

Showroom Hours:
8:00 - 5:00 Mon. - Fri.
10:00 - 3:00 Sat.

WE ACCEPT: VISA • MASTERCARD • AMERICAN EXPRESS
C.O.D. OR CHECKS • SCHOOL P.O.'S

The Biggest
The Best
The Indispensable

The RAINBOW

THE COLOR COMPUTER MONTHLY MAGAZINE

THE RAINBOW is the biggest, best, brightest and most comprehensive publication a happy CoCo ever had! **THE RAINBOW** features more programs, more information and more in-depth treatment of the Tandy Color Computer than any other source.

A monthly issue contains nearly 200 pages and up to two dozen programs, 14 regular columns and as many as 12 new product reviews. And advertisements: **THE RAINBOW** is known as *the* medium for advertisers — which means every month it has a wealth of information unavailable anywhere else about new products! Hundreds of programs are advertised in its pages each month.

Every single issue of **THE RAINBOW** covers the wide spectrum of interests in the Tandy Color Computer — from beginners' tutorials and arcade games to telecommunications and business and finance programs. Helpful utilities and do-it-yourself hardware projects make it easy and fun to expand your CoCo's capabilities. And, monthly reviews by independent reader reviewers take the guesswork out of buying new software and hardware products.

Join the tens of thousands who have found **THE RAINBOW** to be an absolute necessity for their CoCo. With all this going for it, is it surprising that more than 90 percent of **THE RAINBOW** subscribers renew their subscriptions? We're willing to bet that, a year from now, you'll be doing the same.

Rainbow On Tape & Rainbow On Disk!

— great ways to bring **THE RAINBOW** into your life. Each month, all you do is pop the tape into your cassette player or the disk into your drive. No more lost weekends. As soon as you read an article about a program in **THE RAINBOW**, it's ready to load and run. No work. No wait.

Just think how your software library will grow. With your first year's subscription, you'll get almost 250 new programs: games, utilities, business programs, home applications. And, with **RAINBOW ON DISK**, you'll also get all the OS-9 programs.

RAINBOW ON TAPE and **RAINBOW ON DISK** — they're the "meat" of **THE RAINBOW** at a price that's "small potatoes." And now you even have a choice about how it should be served up to you.

To get your first heaping helping, just fill out and return the attached reply card. No postage necessary.

NO POSTAGE
NECESSARY
IF MAILED
IN THE
UNITED STATES

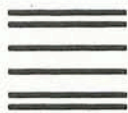
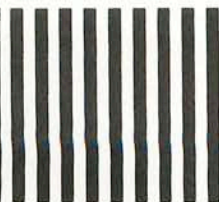

BUSINESS REPLY CARD
FIRST CLASS PERMIT NO. 1 PROSPECT, KY

POSTAGE WILL BE PAID BY ADDRESSEE

RAINBOW
THE COLOR COMPUTER MONTHLY MAGAZINE

The Falsoft Building
P.O. Box 385
Prospect, KY 40059-9989

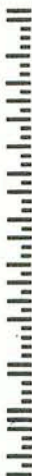

NO POSTAGE
NECESSARY
IF MAILED
IN THE
UNITED STATES

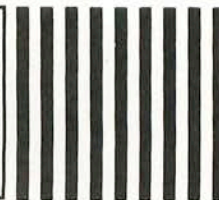

BUSINESS REPLY CARD
FIRST CLASS PERMIT NO. 1 PROSPECT, KY

POSTAGE WILL BE PAID BY ADDRESSEE

RAINBOW
THE COLOR COMPUTER MONTHLY MAGAZINE

The Falsoft Building
P.O. Box 385
Prospect, KY 40059-9989

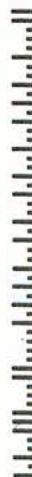

Use our 800 number!

For credit card orders, you may want to phone in your subscription. Our credit card order number is (800) 847-0309, 8 a.m. to 5 p.m. EST. All other inquiries please call (502) 228-4492.

We accept VISA, MasterCard and American Express.

Subscriptions to **THE RAINBOW** are \$31 a year in the United States. Canadian rate is \$38 (U.S. funds only). Surface rate elsewhere is \$68 (U.S.). Airmail is \$103 (U.S.). All subscriptions begin with the current issue. Please allow 6 to 8 weeks for the first copy. Kentucky residents add 5% sales tax. In order to hold down non-editorial costs, we do not bill.

Send Me Rainbow Magazine!

Here's your chance to have a Pot 'O' Gold full of programs, articles and information about CoCo every month of the year!

As the premier magazine for the Tandy Color Computer, **THE RAINBOW** has more of everything — and greater variety, too. Do yourself and your CoCo a favor and subscribe to **THE RAINBOW** today!

YES! Sign me up for a year (12 issues) of **THE RAINBOW**.

NEW RENEW (attach label)

Name _____

Address _____

City _____ State _____ ZIP _____

Payment Enclosed (payment must accompany order)

Charge: VISA MasterCard American Express

Account Number _____

Signature _____ Card Expiration Date _____

Our 800 number is also good for ordering RAINBOW ON TAPE or RAINBOW ON DISK!

Just call (800) 847-0309 anytime from 8 a.m. to 5 p.m. EST. Credit card orders only. Subscriptions to **RAINBOW ON TAPE** are \$80 a year in the United States, \$90 (U.S. funds) in Canada and \$105 (U.S.) in all other countries.

RAINBOW ON DISK is \$99 a year in the United States, \$115 (U.S.) in Canada and \$130 (U.S.) in all other countries.

Individual issues of **RAINBOW ON TAPE** are \$10 in the U.S., \$12 (U.S.) in Canada and all other countries. Individual issues of **RAINBOW ON DISK** are \$12 in the U.S., \$14 (U.S.) in Canada, and \$16 (U.S.) in all other countries. Kentucky residents please add 5% sales tax.

RAINBOW ON TAPE and **RAINBOW ON DISK** are not stand-alone products; you need the magazine for loading and operating instructions and the necessary documentation. **THE RAINBOW** magazine is a separate purchase.

Give Your Fingers A Break!

YES! Sign me up: NEW RENEW (attach label)

RAINBOW ON TAPE RAINBOW ON DISK

(Available beginning with the October 1986 issue)

A Full Year Single Issue (specify month & year) _____

Name _____

Address _____

City _____ State _____ ZIP _____

Payment Enclosed (payment must accompany order)

Charge: VISA MasterCard American Express

Account Number _____

Signature _____ Card Expiration Date _____

VIP Writer I III

WORD PROCESSOR • SPELLING CHECKER • PRINT SPOOLER



SCREEN DISPLAY OPTIONS

VIP Writer III has a screen of 32, 40, 64, or 80 characters wide by 24 lines using the CoCo 3's hardware display with actual lower case letters. You can choose fore and background colors from up to 64 different hues. Color can be turned ON or OFF for the best possible display using a color or monochrome monitor or TV set. VIP Writer III has a built in on-line context sensitive help facility which displays command usage in easy to read colored windows. VIP Writer III also runs at double clock speed!

TEXT FILE STORAGE

There is a 49K text buffer and disk or cassette file linking allowing virtually unlimited text space. In addition VIP Writer III is compatible with the RGB Computer Systems HARD DISK.

"...Nearly every feature and option possible to implement on the Color Computer. The design of the program is excellent; the programming is flawless." -The RAINBOW October 1983

EDITING FEATURES

VIP Writer III has a full featured screen editor which can be used to edit text with lines up to 240 characters long with or without automatic word wrap around. You can select type-over mode or insert mode. There is even an OOPS command to recall a cleared text buffer. Other editing features include: Type-ahead, typamatic key repeat and key beep for flawless text entry, end of line bell, full four way cursor control with scrolling, top of textfile, bottom of textfile, page up, page down, top of screen, bottom of screen, beginning of line, end of line, left one word, right one word, DELETE character, to beginning or end of line, word to the left or right, or entire line, INSERT character or line, LOCATE and/or CHANGE or DELETE single or multiple occurrence using wildcards, BLOCK copy, move or delete with up to TEN simultaneous block manipulations, TAB key and programmable tab stops, three PROGRAMMABLE FUNCTIONS to perform tasks such as auto column creation and disk file linking for continuous printing.

TEXT FORMATTING

VIP Writer III automatically formats your text for you or allows you to format your text in any way you wish. You can change the top, bottom, left or right margin and page length. You can set your text flush left, center or flush right. You can turn right hand justification on or off. You can have headers, footers, page numbers and TWO auxiliary lines which can appear on odd, even or all pages. You can also select the line on which they appear! You can even change the line spacing! All of these parameters can be altered ANYWHERE within your text file.

TEXT FILE COMPATIBILITY

VIP Writer III creates ASCII text files which are compatible with all other VIP Programs as well as other programs which use ASCII file format. You can use VIP Writer III to create BASIC, assembly, PASCAL or C files. VIP Writer III also allows you to save and load files using DISK or CASSETTE in the case of an emergency. You can even read disk directories, display free space on a disk and rename or kill disk files.

SD ENTERPRISES

(503) 663-2865 8:30 AM to 5:00 PM PST
P. O. Box 1233 Gresham, OR 97030

PREVIEW PRINT WINDOW

The VIP Writer III features a paper saving format window which allows you to preview your document BEFORE PRINTING IT! You are able to see centered text, margins, page breaks, orphan lines etc. This feature makes hyphenation a snap!

PRINTING

VIP Writer III supports most any printer serial or parallel using the parallel interface described in Nov-Dec. '87 RAINBOW magazine, or an external serial to parallel interface, and gives you the ability to select baud rates from 110 to 9600. You are able to imbed printer control codes anywhere in your text file EVEN WITHIN JUSTIFIED TEXT! VIP Writer III also has twenty PROGRAMMABLE PRINTER SEQUENCES which allow you to easily control all of your printers capabilities such as underline, bold, italics, superscript and subscript using simple keystrokes. Additional printer features include: single sheet pause, print pause, word length and line feed selection.

PRINT SPOOLING

VIP Writer III incorporates a built in print spooler with a 49,000 character buffer which allows you to print one document WHILE you are editing another. You no longer have to wait until your printer is done printing before starting another job!

DOCUMENTATION

VIP Writer III is supplied with a 125 page instruction manual which includes a tutorial, glossary of terms and a complete index. The manual is well written and includes many examples to aid in understanding and application. VIP Writer III includes VIP Speller at **NO ADDITIONAL COST.** DISK \$79.95
Cassette version does not include VIP Speller. TAPE \$59.95

VIP Writer owners: Upgrade to the VIP Writer III Disk for \$49.95 or Tape for \$39.95. Send original product. Include \$3 shipping.

VIP WRITER - THE ORIGINAL

VIP Writer is also available for CoCo 1 and 2 owners and has all the features found in the VIP Writer III including VIP Speller except for the following: The screen display is 32, 51, 64 or 85 columns by 21 or 24 rows. Colors other than green, black or white are not supported. Help is not presented in colored windows. Double clock speed is not supported. Parallel printer interface is not supported. Print spooler is not available. Hard disk is not supported. Even so, the VIP Writer is a CoCo 1 or 2 owners best choice in word processors. VIP Writer includes VIP Speller at **NO ADDITIONAL COST.** DISK \$69.95
Cassette version does not include VIP Speller. TAPE \$49.95

VIP SPELLER SPELLING CHECKER

VIP Speller works with ANY ASCII file created by most popular word processors. It automatically checks text files for words to be corrected, marked for special attention or even added to the dictionary. You can even view the misspelled word in context! VIP Speller comes with a specially edited 50,000 word dictionary, and words can be added to or deleted from the dictionary or you can create one of your own. DISK \$34.95

Please add \$3.00 for shipping and handling. COD orders add an additional \$2.25. Personal checks allow 3 weeks for delivery. All other orders are shipped the same day.

7DFE	9F	88	Ø3Ø8Ø	STX <\$88	*COLOUR NUMBER QUERY
7EØØ	8E	7F93	Ø3Ø9Ø	LDX #CMESS2	*GET MESSAGE LOCATION
7EØ3	BD	7E9D	Ø31ØØ	JSR PRINT	*PRINT IT
7EØ6	8E	Ø5AØ	Ø311Ø	LDX #\$Ø5AØ	*SET CURSOR POSITION FOR RESPON
SE					
7EØ9	1Ø8E	7FEC	Ø312Ø	LDY #CTABLE	*POINT Y INTO COLOUR TABLE
7EØD	C6	7Ø	Ø313Ø	LDB #\$7Ø	*B HOLDS ASCII VALUE FOR 'Ø'
7EØF	E7	84	Ø314Ø	AGAIN STB ,X	*PRINT B ON SCREEN
7E11	86	7D	Ø315Ø	LDA #\$7D	*NOW PRINT AN
7E13	A7	Ø1	Ø316Ø	STA 1,X	*'=' ON THE SCREEN
7E15	BD	7EA8	Ø317Ø	GETIT JSR GETKEY	*GO AND WAIT FOR RESPONSE
7E18	8Ø	3Ø	Ø318Ø	SUBA #\$3Ø	*NOW A SHOULD HAVE VALUE Ø-3
7E1A	2B	F9	Ø319Ø	BMI GETIT	*IF IT'S NEGATIVE, TRY AGAIN
7E1C	81	Ø7	Ø32ØØ	CMPA #7	*IS IT >7?
7E1E	22	F5	Ø321Ø	BHI GETIT	*YES, TRY AGAIN
7E2Ø	A7	AØ	Ø322Ø	STA ,Y+	*OTHERWISE, STORE IT IN 'CTABLE
,					
7E22	8B	7Ø	Ø323Ø	ADDA #\$7Ø	*ADD TO GET PROPER SCREEN CHARA
CTER					
7E24	A7	Ø2	Ø324Ø	STA 2,X	*PRINT IT ON THE SCREEN
7E26	3Ø	Ø8	Ø325Ø	LEAX 8,X	*MOVE X TO NEXT RESPONSE LOCATI
ON					
7E28	5C		Ø326Ø	INCB	*INCREMENT COUNTER
7E29	C1	74	Ø327Ø	CMPB #\$74	*IS IT LOWER THAN '4'?
7E2B	25	E2	Ø328Ø	BLO AGAIN	*YES, GET NEXT RESPONSE
7E2D	39		Ø329Ø	RTS	*NO, THEN RETURN
			Ø33ØØ *		
			Ø331Ø	*DUMP BUFFERS TO PRINTER	
			Ø332Ø *		
7E2E	8D	6Ø	Ø333Ø	DUMPØ BSR GRAFIX	*GO SEND CONTROL CODES TO PRINT
ER					
7E3Ø	8E	7B8C	Ø334Ø	LDX #RBUF	*POINT X TO BEGINNING OF BUFFER
7E33	A6	8Ø	Ø335Ø	DUMP1 LDA ,X+	*GET NEXT BYTE
7E35	7D	7BEF	Ø336Ø	TST ENLRG	*TEST FOR LARGE PICTURE
7E38	26	Ø9	Ø337Ø	BNE ENLARG	*YES, THEN ENLARGE DATA
7E3A	BD	A2BF	Ø338Ø	JSR \$A2BF	*OTHERWISE SEND A TO PRINTER
7E3D	8C	7BEC	Ø339Ø	BDUMP CMPX #32+BBUF	*END OF BUFFERS?
7E4Ø	25	F1	Ø34ØØ	BLO DUMP1	*NO, GET NEXT BYTE
7E42	39		Ø341Ø	RTS	*YES, THEN RETURN
			Ø342Ø *		
			Ø343Ø	*ROUTINE TO ENLARGE DATA	
			Ø344Ø	*EACH BIT IS EXPANDED	
			Ø345Ø	*INTO TWO BITS.	
			Ø346Ø *		
7E43	34	Ø2	Ø347Ø	ENLARG PSHS A	*SAVE BYTE TO SEND
7E45	84	FØ	Ø348Ø	ANDA #24Ø	*CLEAR RIGHT NIBBLE
7E47	85	1Ø	Ø349Ø	BITA #16	*TEST BIT 4
7E49	27	Ø2	Ø35ØØ	BEQ T32	*BRANCH IF CLEAR
7E4B	88	13	Ø351Ø	EORA #19	*SET BITS Ø,1 RESET BIT 4
7E4D	85	2Ø	Ø352Ø	T32 BITA #32	TEST BIT 5
7E4F	27	Ø2	Ø353Ø	BEQ T64	*BRANCH IF CLEAR
7E51	88	2C	Ø354Ø	EORA #44	*SET BITS 2,3 RESET BIT 5
7E53	85	4Ø	Ø355Ø	T64 BITA #64	*TEST BIT 6
7E55	27	Ø2	Ø356Ø	BEQ T128	*BRANCH IF CLEAR
7E57	88	7Ø	Ø357Ø	EORA #112	*SET BITS 4,5 RESET BIT 6
7E59	85	8Ø	Ø358Ø	T128 BITA #128	*TEST BIT 7

OWL-WARE

Proven Technology New CoCo 3 Utilities

Great for 512K Systems! From Color Venture and OWL-WARE

PRINTER LIGHTNING

A great print spooler which gives you 44K print buffer from a 128K CoCo and up to 438K (200 pages!) from a 512K CoCo. With this spooler you can run a program while you are printing a file. The spooler does not slow down the computer to any noticeable extent while you are running a second program and no lost characters arise. Baud rates selectable. *Printer Lightning* can reside in memory along with *RAMDISK*!

RAMDISK

Using 512K CoCo 3 you have access to 2 additional disk drives in RAM. All disk commands are supported, and the data are Reset button protected. You can now have up to 5 disk drive capacities on line at once and can assign the ram disks to any drive number. By making the ramdisk Drive 0, all programs which require a lot of drive access will run much faster. You can have the *RAMDISK* in memory at the same time as the *Printer Lightning*!

BACKUP LIGHTNING

This program is the fastest way to make backup copies of your files using a 512K CoCo. You can backup 35, 40, or 80 track disks single or double sided. Both RS and OS-9 disks may be backed up. The original disk is saved to memory and a copy can be made on an *unformatted disk* every 45 seconds! The lightning read, write, format, and verify routines that were developed make this program much quicker than RSDOS or OS-9 for backups. This will become one of your most used programs!

• **NEW · NEW ·**

Only \$19.95 each. 3 for \$39.95.

SPECIAL With our 512K Upgrade (Next page) only \$2. each or 3 for \$5!

Announcing:

The finest graphics/drawing program for the COCO 3!

Da Vinci 3

- 16 colors on screen at one time
- Modify each color from 64 available colors
- Use composite or RGB monitor
- Draw with custom paintbrushes
- Full resolution 320 X 192
- Picture converter for conversion of COCO 2 pictures to COCO 3
- Multiple text fonts
- Accepts input from joystick, X-pad, mouse, or touch-pad
- Boxes, circles, line, paint generation
- Screen dump for Tandy mono and color ink-jet printers, (NX-10 and others pending)
- Sensible price
- No additional hardware required because of course/fine joystick movement modes
- Zoom mode for individual pixel editing
- Great on screen menu which is removable at the touch of a key to allow full screen edit

128K or 512K COCO 3

\$37.95

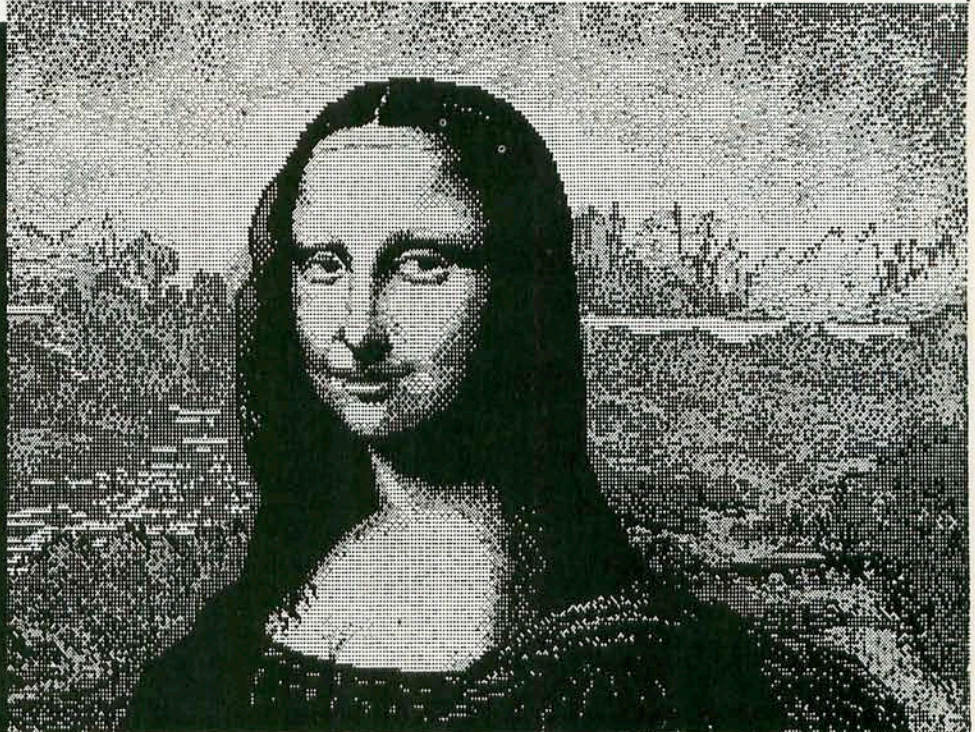

Super I/O Board for OS-9

Each Board Provides 2 Serial Ports and Centronics Parallel Port
First Board has Real Time Clock and Beeper... With Second Board up to 5 Users

The serial ports are usable up to 19,200 Baud, and the parallel port is a true Centronics standard. Plug into your multi-pak. On CoCo 3, multi-pak must be upgraded. You will have a multi-user system with additional computers or terminals plugged into the serial ports. An OWL hard drive and 512K upgrade are strongly recommended for multi-user systems.

Intro Price... \$169.

BOARD 2... \$145.

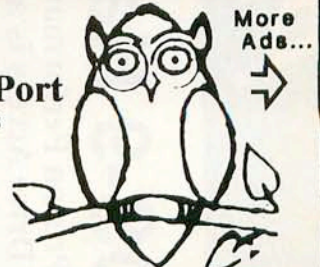
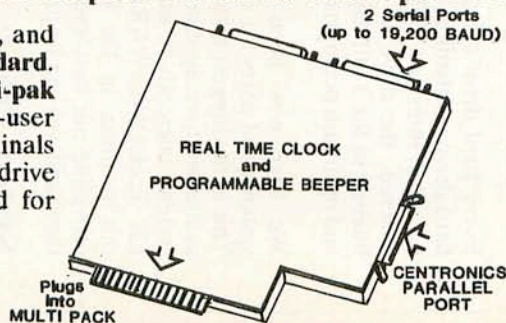

OWL-WARE

P.O. Box 116-A

Mertztown, PA 19539

— ORDER LINES (only) —

(800) 245-6228

(215) 682-6855 (PA)

Proven Technology

On the Razor's Edge of the Color Computer Frontier

OS-9 Hard Drive Systems

**Proven Performance for Demanding Home or Business Use
Drive Access is at Least 8 Times Faster than Floppy Drives
Control up to 2 Drives per Controller each as Continuous Storage**

Every hard drive system is complete with software, hard drive, controller, heavy-duty power supply, and LR Tech Interface. When a complete drive system is ordered, the drive is fully assembled, tested, and burned in for 3 full days. This ensures dependability and optimum performance.

We have now been supplying CoCo hard drive systems and parts for systems for more than 2 years. This is the longest history in the CoCo market of any available drive system. About 3/4 of all hard drive systems currently in use in the CoCo market use the LR Tech/OWL-WARE system. We have reached this position in the CoCo hard drive market by providing our customers with a quality product that they (and we) can be proud to own and use.

System Prices: New!

\$469. 20 Meg. 40 Meg. 80 Meg. (2x40 Meg.)

\$739. \$1,069.

A number of drive systems were in the market place when the LR Tech Interface was introduced and 2 have been introduced since. Most of these are no longer available. We provide the only system which provides a combination of standard interface (SASI), rugged unit construction (not hacked to a floppy drive controller), high speed, and reasonable price. These systems are even several times faster than the standard XT hard drive system. Ideal for multi-user system because processor does not stop for hard drive access.

**For OS-9
Levels 1
and 2**

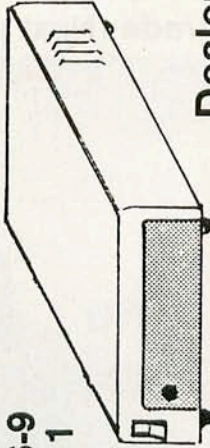

**Dealers
Inquiries Invited!**

Hard Drive Interface (Includes Software)

For those who want to put together their own system, we have an exclusive arrangement to distribute the LR Tech Interface. Please note that an interface is not a controller. A Xebec, WD, or Adaptec SASI controller are required for a drive system.

To assemble a hard drive system yourself requires some reasonable knowledge of OS-9 and electronic construction and a hard drive that works. CoCo 3 users will have to upgrade their Multi-pak.

Only \$119.

Xebec Controller \$135.

CoCo 3 512K Upgrade

The LR Tech 512K upgrade uses all gold contacts and 120 nanosecond 256K chips. Provides large system memory from OS-9 Level 2.

**Without
Mem Chips \$49.**

**With (CALL: Sorry,
Chips the price of
RAMCHIPS is
going up)**

Special! See software offer on previous page.

Hard Drive Basic

New For the CoCo 3!

In Answer for the Many Requests to Run BASIC from a Hard Drive

With the development of the CoCo 3, OWL Ware has been able to provide a truly professional Hard Drive System using OS-9. There has not, however, been a method of running your programs from the standard BASIC. With this latest development of the CoCo software accs, it is now possible to partition your hard drive into RSDOS and OS-9 sections. The OS-9 partition runs your OS-9 normally. The RSDOS section is further divided into a number of floppy sized units to run RSDOS programs. The familiar RS disk commands work normally.

There is little more that must be learned.

All of these RS drive sections are available at all times. It is not necessary to use assign commands and get access to only a few of these sections. Programs that use RS-BASIC should work as will all programs which do not force their own disk drivers.

Call about prices. This should be available by the time you read this ad!

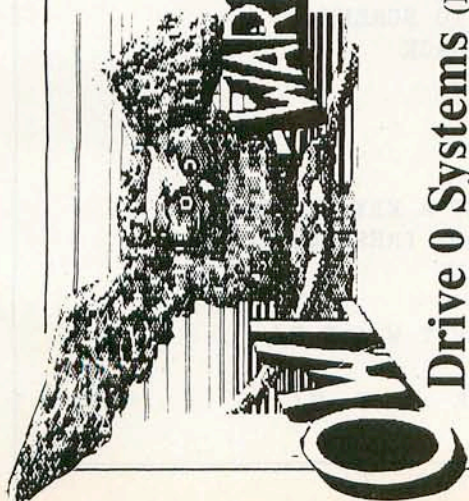

DISK DRIVES

OWL-WARE PHONES
ORDERS
(800) 245-6228
PA (215) 682-6855
TECHNICAL HELP
(215) 433-8695
Call for advice

Ask for the *WHISPER DRIVE* for the finest, quietest drive available!

- Drive 0 Systems (Full Hgt) \$169.** (Half Hgt - DS) **\$219.**
Drive 0 systems complete with drive, controller, legal DOS, cable, case & power supply, and manual.
- Drive 1 Systems (Full Hgt) \$95.** (Half Hgt - DS) **\$129.**
New! New! (3.5" 720K Drive for OS-9) **\$189.**
Drive 1 has drive, case & power supply, and instructions for use with your drive.

(Call for Special Prices on Drive 0, 1, 2, 3 Combos.)

HALF HEIGHT DRIVE UPGRADE KIT FOR RS HORIZONTAL CASES

Why only double the capacity of your system when you can triple in the same case? Kit includes: double sided drive to fit your case, chip to run both sides of new drive, hardware, and detailed instructions. Takes only 5 minutes.

Model \$119. Model \$129.
501 or 502

Our prices do not include shipping costs, but do include a discount for cash.

OWL-WARE has a liberal warranty policy. During the warranty period, all defective items will be repaired or replaced at our option and at no cost to the buyer except for shipping costs.

Call our technical help line for return authorization numbers. Return of non-defective items or unauthorized returns are subject to a service charge.

**Bonus!
Special
Bundled
Software
with
Disk Drive
Purchase!**

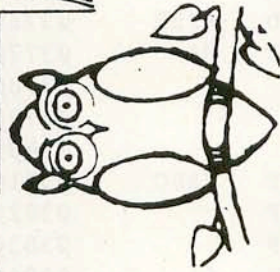

OWL-WARE
P.O. Box 116-A
Mertztown, PA 19539

NOW FOR CoCo 1, 2, 3!!

WARRANTIES
Full Hgt 90 days Half Hgt 1 Year
— ORDER LINES (only) —
(800) 245-6228
(215) 682-6855 (PA)

— TECH HELP LINE —
(215) 433-8695
Call for Latest Prices!

OWL-WARE Software Bundle

Disk Tutorial - 3 Utilities - 2 Games

DISK TUTOR Ver. 1.1

Learn how to use your disk drive from this multi-lesson, machine language program. This tutor takes you through your lessons and corrects your mistakes for a quick, painless disk drive introduction. (This professionally written tutor is easily worth the bundle's total price.)

OWL DOS

An operating system that gives faster disk access and allows the use of double-sided drives. Corrects a floating point number error on early CoCo systems.

COPY-IT

Quickly copies selected programs between disks. A wild card option selects groups of programs for copy.

VERIFY

Verifies reading of each sector. Bad sectors are listed on the screen.

2 GAMES

We will select 2 games from our stock. These have sold for more than \$20 each.

If sold separately this is over \$125 worth of software!!

Do not mistake this software with cheap, non-professional "Public Domain" software which is being offered by others. All of this software is copyrighted and professional in quality. The tutor is unique with us and has helped hundreds of new users learn their disk drive.

only **\$27.95**
(or even better)

only **\$6.95** with
any Disk Drive Purchase!!

7E5B	27	02	03590	BEQ ENLG2	*BRANCH IF CLEAR
7E5D	8A	C0	03600	ORA #192	*SET BITS 6,7
7E5F	BD	A2BF	03610 ENLG2	JSR \$A2BF	*SEND A TO PRINTER
7E62	35	02	03620	PULS A	*RECOVER ORIGINAL VALUE
7E64	84	0F	03630	ANDA #15	*CLEAR LEFT NIBBLE
7E66	85	08	03640	BITA #8	*TEST BIT 3
7E68	27	02	03650	BEQ T4	*BRANCH IF CLEAR
7E6A	88	C8	03660	EORA #200	*SET BITS 6,7 RESET BIT 3
7E6C	85	04	03670 T4	BITA #4	*TEST BIT 2
7E6E	27	02	03680	BEQ T2	*BRANCH IF CLEAR
7E70	88	34	03690	EORA #52	*SET BITS 4,5 RESET BIT 2
7E72	85	02	03700 T2	BITA #2	*TEST BIT 1
7E74	27	02	03710	BEQ T1	*BRANCH IF CLEAR
7E76	88	0E	03720	EORA #14	*SET BITS 2,3 RESET BIT 1
7E78	85	01	03730 T1	BITA #1	*TEST BIT 0
7E7A	27	02	03740	BEQ ENLG3	*BRANCH IF CLEAR
7E7C	8A	03	03750	ORA #3	*SET BITS 0,1
7E7E	BD	A2BF	03760 ENLG3	JSR \$A2BF	*SEND A TO PRINTER
7E81	20	BA	03770	BRA BDUMP	
			03780 *		
			03790	*ROUTINE TO CLEAR BUFFERS	
			03800 *		
7E83	8E	7B8C	03810 CLEAR0	LDX #RBUF	*POINT X TO START OF BUFFER
7E86	4F		03820	CLRA	*CLEAR OUT
7E87	5F		03830	CLRB	*REGISTER D
7E88	ED	81	03840 CLEAR	STD ,X++	*CLEAR TWO BYTES IN BUFFER
7E8A	8C	7BEC	03850	CMPX #32+BBUF	*ARE WE DONE?
7E8D	25	F9	03860	BLO CLEAR	*NO, LOOP BACK
7E8F	39		03870	RTS	*YES, THEN RETURN
			03880 *		
			03890	*ROUTINE TO SEND GRAFICS SETUP TO PRINTER	
			03900 *		
7E90	8E	7FE8	03910 GRAFIX	LDX #PTABLE	*POINT X TO CODE TABLE
7E93	A6	80	03920 GRLOOP	LDA ,X+	*GET NEXT BYTE
7E95	27	05	03930	BEQ GRFOUT	*IF IT'S ZERO THEN BRANCH OUT
7E97	BD	A2BF	03940	JSR \$A2BF	*OTHERWISE SEND A TO PRINTER
7E9A	20	F7	03950	BRA GRLOOP	*AND LOOP BACK
7E9C	39		03960 GRFOUT	RTS	*RETURN
			03970 *		
			03980	*ROUTINE TO PRINT A MESSAGE	
			03990	*POINTED TO BY X.	
			04000 *		
7E9D	A6	80	04010 PRINT	LDA ,X+	*GET NEXT CHARACTER
7E9F	27	06	04020	BEQ POUT	*IF IT'S ZERO, BRANCH OUT
7EA1	AD	9F A002	04030	JSR [CHROUT]	*SEND TO SCREEN
7EA5	20	F6	04040	BRA PRINT	*LOOP BACK
7EA7	39		04050 POUT	RTS	*RETURN
			04060 *		
			04070	*GET RESPONSE FROM KEYBOARD	
			04080 *		
7EA8	AD	9F A000	04090 GETKEY	JSR [POLCAT]	*GO GET A KEY PRESS
7EAC	27	FA	04100	BEQ GETKEY	*IF NONE PRESSED, LOOP.
7EAE	39		04110	RTS	*RETURN
			04120 *		
7EAF		20	04130 TITLE	FCC / T L S S O F T W A R E /	
7ECB		0D0D	04140	FDB \$0D0D	
7ECD		20	04150	FCC / P R E S E N T S /	

7EE8	ØDØD	Ø416Ø	FDB	ØØDØD	
7EEA	2Ø	Ø417Ø	FCC	/	IMAGE V1.3/
7EFF	ØD	Ø418Ø	FCB	ØØD	
7FØØ	2Ø	Ø419Ø	FCC	/	FOR THE RADIO SHACK CGP-22Ø/
7F1D	ØØ	Ø42ØØ	FCB	Ø	
7F1E	45	Ø421Ø	QUERY1	FCC	/ENLARGE ?/
7F27	ØØ	Ø422Ø	FCB	Ø	
7F28	5Ø	Ø423Ø	QUERY2	FCC	/PMODE ?/
7F2F	ØØ	Ø424Ø	FCB	Ø	
7F3Ø	2Ø	Ø425Ø	CMESS	FCC	/ Ø=BLACK 4=BLUE/
7F46	ØD	Ø426Ø	FCB	ØØD	
7F47	2Ø	Ø427Ø	FCC	/	1=WHITE 5=YELLOW/
7F5F	ØD	Ø428Ø	FCB	ØØD	
7F6Ø	2Ø	Ø429Ø	FCC	/	2=RED 6=VIOLET/
7F78	ØD	Ø43ØØ	FCB	ØØD	
7F79	2Ø	Ø431Ø	FCC	/	3=GREEN 7=MAGENTA/
7F92	ØØ	Ø432Ø	FCB	Ø	
7F93	54	Ø433Ø	CMESS2	FCC	/TYPE COLOUR # FOR SCREEN VALUE/
7FB1	ØØ	Ø434Ø	FCB	Ø	
7FB2	65	Ø435Ø	PMESS	FCC	/eVEN RED OR oDD RED?/
7FC6	ØØ	Ø436Ø	FCB	Ø	
7FC7	5Ø	Ø437Ø	BLKWHT	FCC	/PRINT SET BITS AS bLACK OR wHITE/
7FE7	ØØ	Ø438Ø	FCB	Ø	
7FE8	1B43	Ø439Ø	PTABLE	FDB	\$1B43 *VALUES TO SET PRINTER
7FEA	2ØØØ	Ø44ØØ	FDB	\$2ØØØ	*TO COLOR-SCAN MODE
7FEC	ØØ	Ø441Ø	CTABLE	FCB	Ø *VALUES Ø-7 CORRESPONDING TO
7FED	Ø1	Ø442Ø	FCB	1	*INK COLOURS IN 'JTABLE'
7FEE	Ø2	Ø443Ø	FCB	2	*THESE ARE INDIRECT JUMPS TO TH
E					
7FEF	Ø3	Ø444Ø	FCB	3	*COLOUR ROUTINES ABOVE
7FFØ	7DAA	Ø445Ø	JTABLE	FDB	BLACK
7FF2	7DAB	Ø446Ø	FDB	WHITE	
7FF4	7DB2	Ø447Ø	FDB	RED	
7FF6	7DBC	Ø448Ø	FDB	GREEN	
7FF8	7DC8	Ø449Ø	FDB	BLUE	
7FFA	7DD4	Ø45ØØ	FDB	YELLOW	
7FFC	7DDE	Ø451Ø	FDB	VIOLET	
7FFE	7DD9	Ø452Ø	FDB	MAGENT	
	7BF6	Ø453Ø	END	START	

ØØØØØ TOTAL ERRORS

CONNECT YOUR COCO TO THE REAL WORLD WITH A SERIAL OUTPUT INTERFACE!

● HUNDREDS OF APPLICATIONS... ENERGY MANAGEMENT, EXPERIMENTS, EDUCATIONAL USE, ROBOTICS, EQUIPMENT AUTOMATION, LIGHTING CONTROLLERS... THE LIST GOES ON AND ON, LIMITED ONLY BY YOUR IMAGINATION.

● PROVIDES 16 OUTPUT CHANNELS WHICH ALLOW SOFTWARE CONTROL OF 16 DIFFERENT DEVICES. ADDITIONAL CHANNELS CAN BE ADDED WITH OUR EXPANSION CARDS TO INDEPENDENTLY CONTROL HUNDREDS OF DIFFERENT DEVICES.

● DETAILED INSTRUCTIONS PROVIDED, INCLUDING SOFTWARE EXAMPLES WHICH USE SIMPLE BASIC COMMANDS TO TURN OUTPUT DEVICES ON OR OFF. FULL TECHNICAL SUPPORT PROVIDED OVER THE TELEPHONE BY OUR STAFF.

● CONNECTS DIRECTLY TO COCO SERIAL I/O PORT WITH A STANDARD PRINTER CABLE. BAUD RATE AND PROTOCOL FACTORY SET TO STANDARD PRINTER CONFIGURATION FOR COCO 1, 2, OR 3 (600 BAUD).

● COMPATIBLE WITH MOST COMPUTERS WHICH UTILIZE THE STANDARD 25 PIN RS 232 CONNECTOR WITH OUR OPTIONAL RS 232 CABLE.

● DESIGNED FOR CONTINUOUS OPERATION 24 HOURS A DAY, 365 DAYS A YEAR. HIGH QUALITY INDUSTRIAL GRADE COMPONENTS WITH PROVEN RELIABILITY.

AR-16 SERIAL OUTPUT INTERFACE*..... \$89.95

* (REQUIRES CABLES, RELAYS AND SUPPLY)

273-1652A 12V 500MA POWER SUPPLY..... \$10.95

26-3020 PRINTER CABLE FOR COCO..... \$ 4.95

RD-8 REED RELAY CARD (8 RELAYS SP NO)..... \$36.95

ACCESSORIES

EX-16 EXPANSION CARD (16 CHANNEL)..... \$69.95

E-1 EXPANSION CARD CONNECTOR..... \$ 9.95

RS 232 CABLE CONNECTOR (25 PIN)..... \$ 9.95

---ADD \$3.00 SHIPPING CHARGE---

24 HOUR ORDER LINE
(614) 464-4470



ELECTRONIC ENERGY CONTROL, INC. 380 S. FIFTH STREET, SUITE 604 COLUMBUS, OHIO 43215



If you have an idea for the "Wishing Well," submit it to Fred c/o THE RAINBOW. Remember, keep your ideas specific, and don't forget this is BASIC. All programs resulting from your wishes are for your use, but remain the property of the author.

Sometimes a single sentence in a reader's letter can stimulate an idea for a whole program. Other times, ideas from several different sources synthesize into a single listing. It is really funny how ideas for programs are born.

For this month's program I must admit I felt a little at a loss. Just stop and think of how many programs appear in this column every year. I'm not complaining, mind you, but everyone runs into writer's block eventually. Most of the suggestions I have received in past months have not been practical, and I was hoping for something that would have great educational value. (Yes, I am working on a new game, but it's taking several months to put together.)

Then an idea came from the most unlikely of sources. During my 10-minute homeroom period, a new student came up to me with an assignment sheet he had been given in his science class. The worksheet had a list of sentences for him to decode.

Normally I am opposed to using things like word search puzzles because most of my students have a difficult time reading words forward, let alone backward and upside down. Too often, classroom assignments like these tend to be "time wasters." Still, there was something different about his assignment that made it very interesting.

The sheet he had was made up of sentences in which the spaces between the words had been jumbled to such a degree that it would take some time to figure out exactly what the original

Fred Scerbo is a special needs instructor for the North Adams Public Schools in North Adams, Massachusetts. He holds a master's in education and has published some of the first software available for the Color Computer through his software firm, Illustrated Memory Banks.

Can you decode these sentences?

Reading and Decoding Skills

By Fred B. Scerbo
Rainbow Contributing Editor

sentence was. The sentence looked sort of like this:

Plants make food by photosynthesis.

When you first see this sentence, you might not understand what's going on. However, if you look closely, you can decode the letters into real words by rearranging the spaces. The sentence above, once decoded, reads: Plants make food by photosynthesis.

From this jumbled sentence came the idea for a whole new program, *Jumble*, to help youngsters learn while using the CoCo. The program would take a sentence and jumble it. The student would then "un-jumble" the sentence and re-enter it into the computer. And users would also have the ability to supply their own sentences in DATA statements in order to create personalized software.

What are the advantages of such a program? Well, first of all, it provides the user with a new and exciting way to review educational material — it's almost like playing a game show. Secondly, a program like this helps to reinforce spelling skills. As I have mentioned in past columns, spelling is a difficult skill to reinforce on a computer. Some of my other programs have dealt with this skill directly; but, as a

rule, most other programs are severely lacking in this area.

The Program

Devising the subroutines in *Jumble* to split up the sentences was actually quite easy. Each sentence from the DATA statements is measured for length using the LEN command. A FOR-NEXT loop counts through each character and deletes any spaces. Then another FOR-NEXT loop randomly inserts spaces back into this new spaceless string.

That was the easy part. Next came a tougher problem. It would not take too much effort simply to use the INPUT or LINEINPUT command to have the user type in a corrected sentence. However, the CoCo displays a 32-character screen on power-up, and the last thing I wanted was to have the user's text split up on the screen. What was needed was a routine that would let the screen appear to be like a word processor — a word-wrap routine.

This part took a little longer than I expected, but the final result was quite satisfying. Using the INKEY\$ command, I wrote a set of commands that allow you to type, backspace and enter just as you do on a word processor; words reaching the end of the screen jump down to the next line. The only thing you are not able to do is move the cursor over the type on the screen. You can only backspace to correct text.

The subroutine is not perfect, however. Because the program is written in BASIC, it does tend to get a little slower as the statement you type gets longer. If you type too fast, you might get ahead of the program. But this should not be too great a problem, as you will be going rather slowly when you try to decode each sentence. You might consider inserting a high-speed poke in the program, provided you have already saved the program to tape or disk. (Note: Be sure to remember that CoCo 1 and 2 can use POKE65495,0 in most cases, while the CoCo 3 can use POKE65497,0. Some CoCos cannot use the high-speed poke when a disk controller is plugged in. When in doubt, leave it out.)

Let's say, for instance, that you want to try the sample sentences I have included in this listing. When the title card comes up on the screen, you may press I for Instructions or Q for Quiz. Many readers have recently requested

that I include an Instructions option, so I figured this was as good a program as any to start with.

After reading the instructions or choosing the quiz, your quiz statements will be selected at random. At various times the screen will read, "Please stand by." This indicates that the program is creating a new jumbled sentence. Once the sentence appears, you may type your response at the bottom of the screen.

If at any point you want to check your progress, press the @ key; and you will be shown our standard score card. You may continue where you left off by pressing C. However, any typing you have done prior to that on a given statement will be lost and the sentence will be rejumbled. (Pressing C after the last problem may confuse the program and give you a blank sentence.)

You may rerun the program by pressing Y or end by pressing N. That really sums up the whole program. *Jumble* is not difficult to use, and it really can be lots of fun. You can actually have two students race to see who gets through all the sentences first, on two different CoCos. (I intentionally left out a timer option as different generations of

CoCos run at different clock speeds, making uniform timing on different CoCos very difficult.)

Adding Your Own Sentences

You can dump my sentences by typing DEL 1000-4999. But the last line of the program must always be 5000 DATA END.

You can add up to 50 sentences of your own by simply typing them into DATA statements starting in Line 1000. For uniformity, put each sentence in quotation marks — this prevents any problems with commas in your data. Here are samples you might try for younger CoCo users, as the data in my listing is a little bit tougher:

```
1000 DATA "TOM HAS A NEW HAT."
1010 DATA "SUE TIED HER SHOES."
1020 DATA "SEE TIGER JUMP."
```

You can make the sentences as simple or as complex as you like, and use the program with students from first grade through high school and beyond. The uses are really unlimited — foreign language statements, algebraic expressions or proofs, scientific notes, etc., are all possibilities. Be sure to save your

new listings to tape or disk under different filenames. You can create a large library of customized educational software for your CoCo.

Many, Many Thanks!

Several months ago I suggested that anyone owning old, unused, dust-collecting CoCos could contact me if they wanted to donate them to a good cause. Since that time (which is actually only two weeks from the time of publication), several very kind people have donated valuable equipment to my special needs students for classroom use. My sincerest thanks go out to Fred Edwards, Paul French and David Brooks. Anyone who has sent equipment since will be acknowledged in future issues.

Once again I will mention that we can still use any old CoCos or disk drives. Anyone who wishes to make such a donation as a tax write-off may contact me at (413) 663-9648 after 9 p.m. (since it is still wrestling season for my team) or contact me at my home address or c/o Drury High School, South Church St., North Adams, MA 01247.

Again, thanks to all of you for your generosity. See you next month. □

KLC SOFTWARE

1121 Finrock • Pasadena, TX 77506
(713) 472-0078

AVATEX 1200e Auto Answer/Dial
100% Hayes compatible with
FREE Compuserve Time - \$95.00

STAR NX-1000 Multi-Font Printer
144 cps Draft/36 cps NLQ - 20 TYPE STYLES!
\$199.95

DS/DD DISKETTES
10 for \$5.95 • 100 for \$44.95
Lifetime Guarantee!

QUME DS/DD half-height Disk Drive
ONLY \$89.95

Send your check or money order or call
(713) 472-0078

C.O.D. accepted • Sorry, no credit cards
Please add \$4.00 for shipping/handling charges

Texas residents: add 7% sales tax

SolidDrive™ by Vidicom Corp

SolidDrive™ - a ramdisk that doesn't forget! Fully Static, battery backed CMOS ram makes SolidDrive™ ready to use instantly. You can forget formatting and copying work files to ramdisk then copying back your changes to floppy. You can forget fear of power failures. The instant power loss occurs, SolidDrive™ write-protects itself and your valuable work. SolidDrive™ gives you state-of-the-art surface mount technology. That's why we have the best guarantee in the industry - Two years limited repair or replacement! SolidDrive™ is compatible with Multi-Pak® and comes complete with OS9® Level 1 or II device driver, formatter and self-test software. Available in 512K and 1 Megabyte versions. Factory upgrades available for 512K version. RSDos Driver now available, treats SolidDrive™ as 3 or 6

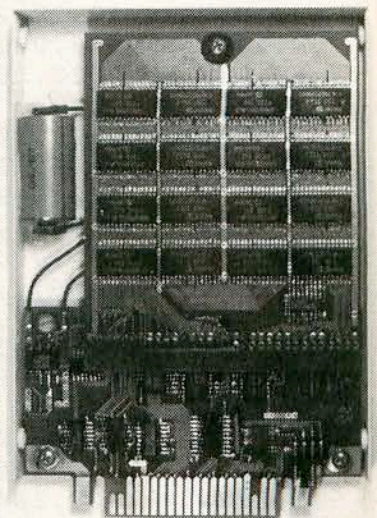

SolidDrive™ by Vidicom Corp	
512K (524,288 bytes)	\$395.00
1 Meg (1,048,576 bytes)	\$695.00
Please add \$4.00 shipping	
Arizona Residents add 5.5% Sales tax	
Visa MasterCard orders welcome	

Vidicom Corp 20 E. Main St. Suite 710
Mesa, AZ 85201 (602) 827-0107
Hours M-F 9:00 am - 5:00 pm MST

SSSD RS devices (4-6,4-9), Disk loaded version free on request!
27C64 EProm version \$19.00

SolidDrive™ is the fastest, most reliable long-term storage available to the small computer user!

OS9 is the trademark of Microware Systems Inc and Motorola Inc. Multi-pak is the trademark of Tandy Corp.

✓	35	90
	80	249
	130	203
	225	66
	315	68
	400	78
	END	59

The listing: JUMBLE

```

1 REM *****
2 REM *   DECODING SKILLS   *
3 REM *   A DECODING GAME   *
4 REM *   BY FRED B. SCERBO *
5 REM *   6Ø HARDING AVE.   *
6 REM *   NORTH ADAMS, MA Ø1247 *
7 REM *   COPYRIGHT (C) 1988 *
8 REM *****
9 CLEAR3ØØØ:CLSØ:PRINTSTRING$(32
,188);STRING$(32,2Ø4);:FORI=1TO2
56:READA:PRINTCHR$(A+128);:NEXT
1Ø PRINTSTRING$(32,195);STRING$(
32,179);
15 DATA29,28,28,26,29,28,29,21,2
8,28,26,3Ø,28,28,26,29,28,28,29,
2Ø,29,28,21,31,18,16,29,24,3Ø,28
,28,29
2Ø DATA21,,,26,21,19,18,21,,,,26
,,,26,21,,,21,,,21,,,16,26,29,18,2
1,,,26,,,19,19
25 DATA21,,,26,21,,,17,21,,,18,26
,,,26,21,,,21,,,21,,,16,26,16,29,2
3,,,26,,,16,21
3Ø DATA28,28,28,24,28,28,28,2Ø,2
8,28,24,28,28,28,24,28,28,28,28,
2Ø,28,28,2Ø,28,16,96,28,24,28,28
,28,28
35 DATA11Ø,1Ø8,1Ø8,1Ø8,1Ø8,1Ø9,1
ØØ,11Ø,,,97,11Ø,,,1Ø8,11Ø,1Ø4,1ØØ,
1Ø9,1Ø8,,,1ØØ,1Ø9,1Ø8,,,96,96,11Ø
,1Ø8,1Ø8,1Ø8,1Ø8,1Ø9
4Ø DATA1Ø7,99,99,99,99,99,,,1Ø7,9
9,11Ø,96,,,1Ø6,,,1Ø1,,,,,1Ø1,,,,
,1Ø7,99,99,99,99,99
45 DATA98,,,,,1Ø1,,1Ø6,,1Ø9,98,,
96,1Ø6,,,1Ø1,,,,,98,1Ø1,,,,,98,98,
,,,1Ø1
5Ø DATA1Ø8,1Ø8,1Ø8,1Ø8,1Ø8,1Ø8,1
ØØ,1Ø4,,,1Ø8,,1Ø8,1Ø8,1Ø4,1ØØ,1Ø
8,1Ø8,1Ø8,1Ø8,1Ø4,1Ø8,1Ø8,1Ø8,1Ø
8,1Ø4,1Ø8,1Ø8,1Ø8,1Ø8,1Ø8,1Ø8
55 PRINT@419,"   BY FRED B. SCE
RBO   ";
6Ø PRINT@453,"   COPYRIGHT (C) 19
88   ";
65 PRINT@483," <I>NSTRUCTIONS OR
<Q>UIZ ";
7Ø X$=INKEY$:XX=RND(-TIMER):IFX$
="I"THEN75ELSEIFX$="Q"THEN135ELS
E7Ø

```

```

75 CLS:PRINT@34,"THIS PROGRAM IS
DESIGNED TO   HELP YOU REVIEW
IMPORTANT     INFORMATION IN
A FUN AND    EXCITING WAY.":
PRINT@194,"YOU WILL BE GIVEN A S
ENTENCE     WHICH HAS THE SPACES
IN IT       JUMBLED AROUND."
8Ø PRINT@322,"YOU MUST RE-TYPE T
HE SENTENCE  SO THAT IT IS CORR
ECT & MAKES  SENSE."
85 PRINT@45Ø,"PRESS <ENTER> TO C
ONTINUE.";
9Ø IFINKEY$<>CHR$(13)THEN9Ø
95 CLS:PRINT@34,"HERE IS AN EXAM
PLE OF SUCH  A SENTENCE:":PR
INT@13Ø,"T HEC OWWA SST ANDING U
P."
1ØØ PRINT@194,"YOU WOULD DECODE
THIS TO READ:":PRINT@258,"THE CO
W WAS STANDING UP."
1Ø5 PRINT@322,"PRESS <ENTER> WHE
N YOU THINK  THAT YOU HAVE THE
SENTENCE     RIGHT."
11Ø PRINT@45Ø,"PRESS <ENTER> TO
CONTINUE.";
115 IFINKEY$<>CHR$(13)THEN115
12Ø CLS:PRINT@34,"IF YOU DO NOT
GET THE ANSWER CORRECT, YOU W
ILL BE GIVEN A CHANCE TO TRY
IT AGAIN. YOU  MAY CHECK THE
SCORECARD BY  PRESSING THE <
@> KEY. YOU MAY THEN RETURN TO
THE PROGRAM BY PRESSING <C> T
O CONTINUE"
125 PRINT@29Ø,"BE SURE TO TYPE S
LOWLY!":PRINT@354,"PRESS <ENTER>
TO BEGIN."
13Ø IFINKEY$<>CHR$(13)THEN13Ø
135 CLSØ
14Ø DIMAO(5Ø),A$(5Ø),B$(5Ø),NP(5
Ø)
145 CLSØ:GOTO18Ø
15Ø D=Ø
155 IFLEN(J$)<=27THEN17Ø
16Ø FORT=27TOØSTEP-1:IFMID$(J$,T
,1)=" "THEN175
165 NEXT
17Ø W$=J$+C$:F=LEN(W$):PRINT@M+D
,W$;STRING$(X-F,32):RETURN
175 W$=LEFT$(J$,T):C$="":W$=W$+C
$:F=LEN(W$):PRINT@M+D,W$;STRING$
(X-F,32):C$=D$:J$=S$+RIGHT$(J$,
(LEN(J$)-T):D=D+32:GOTO155
18Ø FORJ=1TO5Ø:READ A$(J):IFAS$(J
)="END"THEN19Ø
185 NEXTJ
19Ø CLSØ:J=J-1
195 FORI=1TOJ
2ØØ AO(I)=RND(J)
2Ø5 IFNP(AO(I))=1THEN 2ØØ

```

```

210 NP(AO(I))=1:NEXTI
215 FORP=1TOJ
220 CLS:PRINT@232,"PLEASE STAND
BY":A$="":B$="":R$="":C$="":D$="
":S$=" "
225 Q$=A$(AO(P)):K=LEN(Q$)
230 FORN=1TOK:IFMID$(Q$,N,1)=" "
THEN240
235 A$=A$+MID$(Q$,N,1)
240 NEXTN
245 K=LEN(Q$):B$=LEFT$(A$,3):FOR
N=4TOK
250 R=RND(12):IFR>4THEN260
255 B$=B$+" "
260 B$=B$+MID$(A$,N,1):NEXTN
265 CLS:PRINT@35,"DECODE STATEME
NT NO.":P:M=96::J$=" "+B$:X=31
:GOSUB150
270 M=289:PRINT@289,"=>"+CHR$(12
8);
275 X=29:C$=CHR$(128):D$=CHR$(12
8):S$=" "
280 Y$=INKEY$:IFY$="@ "THEN345ELS
EIFY$=CHR$(13)THEN300ELSEIFY$=CH
R$(8)THEN290ELSEIFY$=""THEN280
285 R$=R$+Y$:J$=" "+R$:PRINT@29
1,"";:GOSUB150:PRINT:GOTO280
290 IFLEN(R$)<1THEN280
295 M=289:L=LEN(R$):R$=LEFT$(R$,
L-1):PRINT@M,"";:J$=" "+R$:GOSU
B150:PRINT:GOTO280
300 IFR$=Q$THEN305ELSE315
305 PRINT@480," YOU ARE ABSOLUT
ELY CORRECT!! ";
310 CR=CR+1:GOTO335
315 PRINT@480," SORRY, THAT IS
NOT CORRECT !";
320 IR=IR+1
325 X$=INKEY$:IFX$=CHR$(13)THEN3
00ELSEIFX$="@ "THEN345ELSE325
330 PRINT@480,STRING$(30,32);:GO
TO280
335 X$=INKEY$:IFX$=CHR$(13)THEN3
40ELSEIFX$="@ "THEN345ELSE335
340 NEXTP
345 CLS:PRINT@128,"";
350 L=CR+IR:IF L=0 THEN L=1
355 PRINT" NUMBER CORRECT = "
CR
360 PRINT
365 PRINT" NUMBER WRONG = "
IR
370 PRINT:PRINT" STUDENT SCOR
E = ";INT(CR*100/L);"%
375 PRINT:PRINT" ANOTHER TRY
(Y/N/C)";
380 W$=INKEY$:IFW$=""THEN380
385 IF W$="Y" THEN RUN
390 IF W$="N" THEN CLS:END
395 IF W$="C" THEN 220

```

```

400 GOTO380
990 REM ENTER DATA AT LINE 1000
1000 DATA "FOOD IS AN ESSENTIAL
PART OF EVERYONE'S DAILY LIFE."
1010 DATA "WATER IS AN EVEN MORE
IMPORTANT PART OF A PERSON'S DA
ILY INTAKE."
1020 DATA "YOU COULD GO FOR MORE
DAYS WITHOUT FOOD THAN YOU COUL
D WITHOUT WATER."
1030 DATA "HUMANS ALSO NEED A CE
RTAIN AMOUNT OF SLEEP EACH DAY."
1040 DATA "THE HUMAN BODY MUST B
REAK DOWN FOOD BEFORE IT CAN BE
ABSORBED."
1050 DATA "MANY PEOPLE BELIEVE T
HAT ALL-NATURAL FOODS ARE BETTER
FOR YOU."
1060 DATA "SOME PEOPLE GET VERY
UPSET WITH THE CHEMICALS THEY FI
ND IN THEIR FOOD."
1070 DATA "GOOD EATING HABITS US
UALLY LEAD TO GOOD HEALTH."
1080 DATA "TOO MUCH SUGAR IN YOU
R DIET IS NOT GOOD."
1090 DATA "FIBER IS AN IMPORTANT
PART OF YOUR DIET, TOO."
5000 DATA END

```

VIP™ Library

RAINBOW CERTIFICATION SEAL

VIP Desktop © 1987 SDE

EXIT

The VIP Integrated Library combines all six popular VIP application programs - VIP Writer**, Speller, Calc, Database, Terminal and Disk-Zap - into one program on one disk. The program is called VIP Desktop. From the desktop you have instant access to word processing with a spelling checker always in attendance, data management with mail-merge, spreadsheet financial analysis, tele-communications and disk maintenance. Just move the hand to the volume on the bookshelf and the application is there. 64K req'd.

VIP Integrated Library DISK \$149.95

** CoCo 3 owners: Purchase the VIP Integrated Library /WE (Writer Enhanced) which has VIP Writer III in place of VIP Writer. \$159.95
Previous VIP Library owners upgrade to the VIP Library /WE for \$49.95 + \$3 shipping. Send \$52.95 and original VIP Library disk.

SD Enterprises POB.1233. Gresham, Or. 97030 503 663-2865
Please add \$3.00 for shipping. COD orders add an additional \$2.25. Personal checks allow 3 weeks for delivery. All other orders shipped the same day.

RAINBOW

Give us your best: Join the ranks of these courageous CoCoists in showing the Color Computer world your high score at your favorite micro-diversion. We want to put your best effort on record in THE RAINBOW's "Scoreboard" column. All entries must be received 60 days prior to publication. Entries should be printed — legibly — and must include your full name, address, game title, company name and, of course, your high score. Each individual is limited to three score entries per month. Send your entries to Scoreboard, c/o THE RAINBOW. For greater convenience, your high scores may also be sent to us through the MAIL section of our Delphi CoCo SIG. From the CoCo SIG> prompt, pick MAIL, then type SEND and address to: EDITORS.

★ Current Record Holder ● Shutout

ADVANCED STAR TRENCH (THE RAINBOW, 7/86) 4,750 ★Stephane Martel, Laval, Quebec 4,475 David Schaller, Clarkston, WA 4,300 Jeffrey Warren, Waynesville, NC 3,960 Maurice MacGarvey, Dawson Creek, British Columbia 3,960 Robbi Smith, Helena, HI	DEMON ATTACK (Imagic) 72,410 ★Glenn Hodgson, Aberdeenshire, Scotland 67,760 Jim Davis, Sandwich, IL 40,435 Upton Thomas, Arnold, MD 28,780 Daniel Streidt, Cairo, Egypt 16,995 Todd VanNatta, Isle of Palms, SC	9,200 Jesse Cogdell, Wilmington, DE 5,561 Chris Lorenz, Kiester, MN
ASTRO BLAST (Mark Data) 48,825 ★Tony Bacon, Mt. Vernon, IN	DESERT RIDER (Radio Shack) 80,703 ★Thomas Payton, Anderson, SC 62,702 William Currie, Bryans Road, MD 50,797 Patrick Devitt, Lombard, IL 26,125 Ryan Grady, Newbury Park, CA 24,355 Roby Janssen, Clear Lake, IA	DRAC (Tom Mix) 104,850 ★Don Mullis, Delavan, WI
BEE ZAPPER (THE RAINBOW, 9/87) 10,500 ★Jeff Remick, Warren, MI 9,650 Benoit Landry, Drummondville, Quebec 9,450 Phillip Holsten, Modesto, CA	DEVIL ASSAULT (Tom Mix) 1,866,100 ★Stephane Martel, Laval, Quebec 623,550 Dale Krueger, Maple Ridge, British Columbia 75,000 Blake Cadmus, Reading, PA 40,800 Benoit Landry, Drummondville, Quebec	ESCAPE 2012 (Computerware) 202 ★Roy Grant, Toledo, OH 199 Milan Parekh, Anaheim, CA
BIOSPHERE (Radio Shack) 423 ★Ken Cikas, Sherman, IL	DISCRIMINATION (THE RAINBOW, 1/87) 15 ★Patrick Martel, Laval, Quebec	FIRE COPTER (Adventure International) 77,030 ★Mike LeBrun, Cornwall, Ontario 56,840 Michael Adams, Columbia, SC
BUZZARD BAIT (Tom Mix) 22,931,850 ★Skip Taday, East Lyme, CT 763,550 Geran Stalker, Rivordalo, GA 187,750 Keith Janas, Kitwanga, British Columbia	DONPAN (Radio Shack) 53,100 ★Jim Davis, Sandwich, IL 52,600 Eric Olson, Wheaton, IL	FIRESTORM (THE RAINBOW, 1/86) 22,505 ★Chad Presley, Luseland, Saskatchewan 11,250 Stephane Martel, Laval, Quebec 5,680 Kathy Rumpel, Arcadia, WI 3,760 Rick Beavers, Bloomfield, MN 3,505 Blake Cadmus, Reading, PA
CANYON CLIMBER (Radio Shack) 1,627,500 ★Matthew Fumich, Munford, TN 202,000 David Brown, New Waterford, Nova Scotia 178,200 Darren King, Yorkton, Saskatchewan 169,000 Gregory Speer, Emporia, KS 165,500 Sara Mittelstaedt, Kiel, WI 159,200 Upton Thomas, Arnold, MD 157,200 Emmett Keyser, Napa, CA	DOUBLE BACK (Radio Shack) 172,320 ★Richard Winkelbauer, Bronx, NY 136,510 Don Mullis, Delavan, WI 51,470 Betty Mullis, Delavan, WI 50,700 Tristan Terkuc, Richmond, Ontario 34,990 Darren Lowe, White Rock, British Columbia	GALACTIC ATTACK (Radio Shack) 26,370 ★Jeff Remick, Warren, MI 10,600 Brian Crabtree, College Park, WA 9,930 Daniel Streidt, Cairo, Egypt
CAVE WALKER (Radio Shack) 38,120 ★Steve Stratton, Norfolk, VA	DOWNLAND (Radio Shack) 99,980 ★Danny Wimet, Rome, NY 98,985 Karl Gulliford, Summerville, SC 97,740 Stephane Deshaies, Beloeil, Quebec 89,490 Neil Edge, Williston, FL 77,254 Tom Adams, Fremont, CA 73,346 Jean-Francois Morin, Loretteville, Quebec	GALACTIC FIGHTER (Four Star Software) 153,725 ★Michael Heitz, Chicago, IL
CLOWNS & BALLOONS (Radio Shack) 688,960 ★Faye Keefer, Augusta, GA 70,180 Charles Andrews, Delta Jct, AK 36,650 Melody Webb, Lakeport, CA 15,950 Matthew Smith, Courtenay, British Columbia	DOUBLE BACK (Radio Shack) 70,142 Chris Goodman, Baltimore, MD 68,142 Cooper Valentin, Vavenby, British Columbia 67,721 Keith Yamanis, Jaffrey, NH 62,442 Eddie Lawrence, Pasadena, Newfoundland 55,300 Patrico Gonzalez, Buenos Aires, Argentina 49,500 Danny Perkins, Clifton Forge, VA 49,441 Kevin Pater, Port Alberni, British Columbia 49,254 David Brown, New Waterford, Nova Scotia 43,502 Mike Ellis, Charlotte, MI 41,896 Antonio Hidalgo, San Jose, Costa Rica 40,360 Jesse Binns, Phoenix, AZ 34,424 Andrea Mayfield, Melbourne, FL 25,148 Michelle Murray, Salem, IN 25,147 Timothy O'Neal, Commerce, TX 22,739 Kyle Sheppard, Fairview, NC 19,708 Clifford Lingle, Overland Park, KS	GALAGON (Spectral Associates) 357,890 ★Jason Clough, Houston, TX 328,820 Bernard Burke, Lee's Summit, MO 249,960 Matthew Fumich, Munford, TN 169,410 Danny Dunne, Pittsfield, NH 149,520 Vernon Johnson III, Parkville, MD
COLOR POKER (THE RAINBOW, 4/83) 27,003,600 ★Earl Foster, Lynchburg, VA	DRAGON FIRE (Radio Shack) 160,835 ★Eric Olson, Wheaton, IL 146,325 Stephane Martel, Laval, Quebec 9,861 Michael Adams, Columbia, SC	GALAX ATTACK (Spectral Associates) 236,350 ★Corey Leopold, Nada, TX 28,300 Augusto Voyest, Lima, Peru
DALLAS QUEST (Radio Shack) 81 ★Brad Wilson, Lithia Springs, GA 85 David and Shirley Johnson, Leicester, NC 86 Roy Grant, Toledo, OH 86 Melanie Moor, Florence, AL 86 Paul Summers, Orange Park, FL 87 Douglas Bell, Duncan, OK 89 Chris Piche, White Rock, British Columbia 89 Milan Parekh, Fullerton, CA 89 Andrew Urquhart, Metairie, LA 89 Steve Zemaitis, Howell, MI	GHANA BWANA (Radio Shack) 2,350,750 ★Michael Heitz, Chicago, IL 702,520 Joseph Delaney, Augusta, GA 105,820 David Reash, Hadley, PA	GANTELET (Diecom Products) 23,643,720 ★Geran Stalker, Rivordalo, GA 20,921,490 Randall Edwards, Dunlap, KS 10,222,940 Clinton Morell, Sacramento, CA 10,020,500 Ken Hubbard, Madison, WI 7,493,340 Stirling Dell, Dundalk, Ontario 2,626,950 Jonathon Ross, Pocomoke City, MD 2,512,620 Jason Steele, Pensacola, FL 2,312,640 Rory Kostman, Hershey, NE 2,115,790 Jerry Honigman, Waggoner, IL 2,011,200 Jerry Colbert, Bakersfield, CA 1,245,550 Donald Cathcart, Halifax, Nova Scotia 1,224,190 Jonathan Wanagel, Freeville, NY
DECATHALON (Spectral Associates) 10,400 ★Tom DiVittorio, Glassboro, NJ 7,440 Wayne Hulford, Kincardine, Ontario 7,216 Martin Parada, Arcadia, CA	GIN CHAMPION (Radio Shack) 1,074 ★William Ehardt, Darien, IL	GROBOT (Children's Computer Workshop) 8,090 ★Curt Lebel, Louisville, KY
DEFENSE (Spectral Associates) 16,305 ★Patrick Martel, Laval, Quebec	HITCHHIKER'S GUIDE TO THE GALAXY (Infocom) 400/422 ★Jeff Holtham, Waterloo, Ontario 400/510 Brad Wilson, Lithia Springs, GA	INTERBANK INCIDENT (Radio Shack) 4,861 ★Shara and Chris Euton, Lilburn, GA
DEF MOV (THE RAINBOW, 1/87) 43,806 ★Domingo Martinez, Miami, FL 35,331 David Schaller, Clarkston, WA 31,673 Douglas Bacon, Middletown, CT 30,253 Benoit Landry, Drummondville, Quebec 25,739 John Weaver, Amsterdam, NY	IRON FOREST (Diecom Products) 1,013,100 ★William Waller, Kailua, HI	JOKER POKER (THE RAINBOW, 3/87) 8,179,710 ★Brenda Kim, Athens, OH 2,793,285 Blain Jamieson, Kingston, Ontario 205,239 Paul Dykes, Baton Rouge, LA 13,377 Jason Ebbeling, Berkshire, MA 4,488 Frankie DiGiovanni, Olney, MD

SCOREBOARD

JUNIOR'S REVENGE (Computerware) 2,503,000 257,600	★Stephane Martel, Laval, Quebec Keith Cohen, Rocky Mount, NC	49 14 9	Randy Venable, Coal City, WV Eric Mellon, Newark, DE Laundre Clemon, Sacramento, CA		STORM (Computerware) 113,315 69,645	★Tony Bacon, Mt. Vernon, IN Michael Bacon, Mt. Vernon, IN
JUNKFOOD (THE RAINBOW, 11/84) 25,670 18,650	★John Guptill, Columbia, MO Daniel Streidt, Cairo, Egypt		POLARIS (Radio Shack) 919,085	★Clinton Terry, Toronto, Ontario	SUCCESS MANSION (THE RAINBOW, 1/87) 13/13	★Dave Allessi, Iselin, NJ
KARATE (Diecom Products) 31,000 11,600 6,300	★Wayne Hufford, Kincardine, Ontario Jonathon Ross, Pocomoke City, MD David Darling, Longlac, Ontario		POLTERGEIST (Radio Shack) 4,855	★Darren Lowe, White Rock, British Columbia	SUPER ROOTER (THE RAINBOW, 5/86) 15,180 11,090	★Richard Donnell, Penns Grove, NJ Frederick Lajoie, Nova Scotia, Canada
KING TUT (Tom Mix) 44,500	★Curt Lebel, Louisville, KY		POOYAN (Datasoft) 34,000	★Ken Cikas, Sherman, IL	3,910	Daniel Bradford, Birmingham, AL
KORONIS RIFT (Epyx) 186,710 184,180 184,120 174,810 133,990	★Tony Harbin, Cullman, AL Russell Johnson, Sarnia, Ontario John Farrar, Lebanon, TN Donald Cathcart, Halifax, Nova Scotia Paul Blessing, Spring, TX		POPCORN (Radio Shack) 94,470 44,010	★Patrick Martel, Laval, Quebec Kevin Pater, Port Alberni, British Columbia	TEMPLE OF ROM (Radio Shack) 303,600 138,400 125,200	★Tim Hennon, Highland, IN Gary Budzak, Westerville, OH Michelle Murray, Salem, IN
KUNG-FU DUDE (Sundog Systems) 32,000	★Tony Geitgy, University Park, PA Cody Deegan, Fallon, NV		25,850	Matthew Leitman, Beaconsfield, Quebec	THEXDER (Sierra On-Line) 195,000 192,600	★Emmett Keyser, Napa, CA Frankie DiGiovanni, Olney, MD
LUNAR RESCUE (THE RAINBOW 8/87) 260,427 259,493 246,668 175,771 113,579	★Tom Beeker, Gracey, KY Cody Deegan, Fallon, NV Phillip Holsten, Modesto, CA Jim Davis, Sandwich, IL Jeff Remick, Warren, MI		PYRAMID (Radio Shack) 220	★Jason Ebbeling, Berkshire, MA	TREASURE QUEST (THE RAINBOW, 11/86) 29,340	★Matthew Smith, Courtenay, British Columbia
LUNCHTIME (Novasoft) 135,500	★Robert Ritter, Minneapolis, MN		PYRAMID 2000 (Radio Shack) 220 100	★Darren King, Yorkton, Saskatchewan Peter Antonacopoulos, Toa Baja, Puerto Rico	TREKBOER (Mark Data) 132 123	★Matthew Fumich, Munford, TN Roy Grant, Toledo, OH
MAGIC OF ZANTH (Computerware) 47	★Robert Williams, Yellowknife, Northwest Territory		PYRAMIX (ColorVenture) 17,170	★Janet Kim, Pinckneyville, IL	TUT'S TUMB (Mark Data) 118,720 74,780 72,000	★Reina Roy, Carleton, Quebec Mack Haynes, Nice, CA Chad Presley, Luseland, Saskatchewan Don Siler, Muncie, IN Blake Cadmus, Reading, PA
MEGA-BUG (Radio Shack) 9,016 8,199 5,528 5,172	★Heather Richwalski, Medford, WI Eric Mellon, Newark, DE Douglas Bacon, Middletown, CT Jason Ebbeling, Berkshire, MA		QUIX (Tom Mix) 8,407,772 1,404,000 1,201,383 1,003,104 326,192	★John Haldane, Tempe, AZ Curtis Goodson, Sao Paulo, Brazil Milan Parekh, Anaheim, CA Elisa Goodson, Sao Paulo, Brazil Martin Parada, Arcadia, CA	RADIO BALL (Radio Shack) 399,999	★Tony Harbin, Cullman, AL ★Edward Rocha, Cobleskill, NY Philip Puffinburger, Winchester, VA Denise Rowan, Minneapolis, MN Ryan Grady, Newbury Park, CA Randall Edwards, Dunlap, KS Bernard Florence, Croydon, Australia Gary Haggard, Cedar Hill, TX
MISSION: F-16 ASSAULT (Diecom Products) 468,750 355,570 318,160 144,510 137,920	★Karen Jessen, Cleveland, OH Stirling Dell, Dundalk, Ontario Jeremy Pruski, Sandwich, IL Donald Cathcart, Halifax, Nova Scotia Mike Grant, Fresno, CA		RESCUE ON FRACTALUS (Epyx) 288,084 270,000 190,915 167,947 148,932	★Donald Cathcart, Halifax, Nova Scotia Russell Johnson, Sarnia, Ontario Leon Beggs, Bellingham, WA Roger Smith, High Prairie, Alberta Mike LeBrun, Cornwall, Ontario	RETURN OF JUNIOR'S REVENGE (Colorware) 1,792,800	★Chad Presley, Luseland, Saskatchewan
MOON HOPPER (Computerware) 82,150 55,270	★Clifford Lingle, Overland Park, KS David Reash, Hadley, PA		RETURN OF THE JET-1 (ThunderVision) 309,250	★Melody Webb, Lakeport, CA	ROGUE (Epyx) 43,222 27,542 21,682 17,851 8,812	★Hans Lutenegger, Madison, IA Melanie Lapoint, Fitchburg, MA Paul Blessing, Spring, TX Yvan Langlois, Laval, Quebec Allen Houk, San Diego, CA
MUNCHKIN BLASTER (THE RAINBOW, 8/87) 11,950 10,420 9,760 9,080 9,000	★Jim Davis, Sandwich, IL Gabe Emerson, Baraboo, WI Tom Beeker, Gracey, KY John Weaver, Amsterdam, NY Benoit Landry, Drummondville, Quebec		SAILOR MAN (Tom Mix) 1,019,200 341,800 332,600 287,200	★Gabriel Assel, Cameron, MO Jason Clough, Houston, TX Jeremy Carter, Spring Lake Park, MN Patrick Devitt, Lombard, IL	SANDS OF EGYPT (Radio Shack) 67 82 86 87 117	★Tristan Terkuc, Richmond, Ontario Edward Rocha, Cobleskill, NY Roy Grant, Toledo, OH Neil Haupt, Elyria, TX John Lente, Austin, TX
OMNIVERSE (Computerware) 109	★Milan Parekh, Anaheim, CA		SAUCER DEFENSE (THE RAINBOW, 4/87) 4,000	★Frankie DiGiovanni, Olney, MD	SHAMUS (Radio Shack) 16,410	★Steve Stratton, Norfolk, VA
ONE-ON-ONE (Radio Shack) 1,302-0 1,276-0 1,242-0 1,210-0 1,204-0 1,160-0	★Thomas Payton, Anderson, SC Jonathan Dorris, Indianapolis, IN William Currie, Bryans Road, MD Gregg Thompson, Chesterfield, VA Chad Johnson, Benton, AR Mark Lang, Downieville, CA		SHOOT'N RANGE (THE RAINBOW, 8/87) 13,794 5,998 5,433	★Phillip Holsten, Modesto, CA Richard Winkelbauer, Bronx, NY Benoit Landry, Drummondville, Quebec	SPACE ASSAULT (Radio Shack) 13,110 6,200	★Jeff Remick, Warren, MI John Weaver, Amsterdam, NY
PARAMISSION (THE RAINBOW, 5/87) 3,500 3,200	★Jim Davis, Sandwich, IL Jeff Remick, Warren, IL		SPEED RACER (MichTron) 81,020	★Wayne Hufford, Kincardine, Ontario	SPEEDSTER (THE RAINBOW 8/87) 32,110 26,190 22,750	★Lisa Williamson, Watauga, TX Melissa Clayton, Hoosick Falls, NY Benoit Landry, Drummondville, Quebec
PEGASUS AND THE PHANTOM RIDERS (Radio Shack) 329,000 303,100 261,000 67,100	★Joseph Delaney, Augusta, GA Mike Grant, Fresno, CA Domingo Martinez, Miami, FL Ryan Grady, Newbury Park, CA		10,500 4,710	Sara Mittelstaedt, Kiel, WI Andrea Reelitz, Greenville, IL	STRATEGY FOOTBALL (THE RAINBOW, 8/83) 153-0	★Michael Heitz, Chicago, IL
PINBALL (Radio Shack) 399,350 389,463 213,300 142,400	★Troy Stoll, Washington, IN Thomas Payton, Anderson, SC Patrick Martel, Laval, Quebec Thomas Payton, Anderson, SC		PITSTOP II (Epyx) 54 54 54 54 54 54 54	★Rusty Breitbach, Rickardsville, IA ★Jeff Coburn, Easton, PA ★Walter Hearne, Pensacola, FL ★Thomas Payton, Anderson, SC ★Jeff Szczereba, Sturtevant, WI ★Sean Noonan, Green Bay, WI ★Brad Wilson, Lithia Springs, GA Christian Grenier, Valleyfield, Quebec	WARP FACTOR X (Prickly-Pear) 10,577,051	★Doug Lute, Clymer, PA
WISHBRINGER (Infocom) 400/201	★Brad Wilson, Lithia Springs, GA		WRESTLE MANIAC (Diecom) 956,971 546,315 45,483 42,105	★Marc Reiter, Cincinnati, OH Louis Bouchard, Gatineau, Quebec Tony Bacon, Mt. Vernon, IN David Brown, New Waterford, Nova Scotia Billy Helmick, Independence, KY	ZAKSUND (Elite Software) 357,550 268,350 44,900 39,950	★Martin Parada, Arcadia, CA Tony Bacon, Mt. Vernon, IN Michael Adams, Columbia, SC Walter Hearne, Pensacola, FL
ZAXXON (Datasoft) 2,061,000 1,950,000 1,300,500 1,100,600 253,400 170,600 163,700 137,200 112,000	★Byron Alford, Raytown, MO Blake Cadmus, Reading, PA Dan Brown, Pittsford, NY Andrew Urquhart, Metairie, LA Bob Dewitt, Blue Island, IL Matthew Yarrows, East Hampton, MA Daniel Bradford, Birmingham, AL Upton Thomas, Arnold, MD Ken Cikas, Sherman, IL		ZONERUNNER (Radio Shack) 65,535	★Donald Cathcart, Halifax, Nova Scotia	ZONX (THE RAINBOW, 10/85) 6,500	★Daniel Streidt, Cairo, Egypt
ZUES (Aardvark) 3,380	★Martin Kertz, Forrest City, AR					

— Jody Doyle

SCOREBOARD POINTERS

In conjunction with THE RAINBOW's Scoreboard, we offer this column of pointers for our game-playing readers' benefit. If you have some interesting hints, tips or responses to questions, or want help yourself, we encourage you to write to the Scoreboard, c/o THE RAINBOW.

Feedback

In response to questions from:

• Greg Fields: To get the scepter in *Sands of Egypt*, you must get the dates and feed them to the camel. Examine the carving on the statue and oil the scepter, then pull the scepter.

• Rick Moore: To get down the ladder in *Dallas Quest*, you must put all the items in the knapsack and type DROP SACK. After you drop the sack, get the flashlight and type CLIMB LADDER, LIGHT LIGHT and DROP LIGHT. After you drop the light, go back to the store and get your sack.

• Brian Hill: To get the torch in *Sands of Egypt*, first you go back to the base of the cliff and go south twice.

In *Sands of Egypt*, I cannot find a way to get the palm fronds. I also do not understand where I can find the ax. What is the ax used for?

In *Dallas Quest*, I am in the cave after you wave the ring to the cannibals. How do I get out?

In *White Fire of Eternity*, I am in the Shrine of Sorts. How do I get the pick? How do I open the box?

Mike Duvall
Zanesville, OH

• Robert Johnston: After you drug the first spider in *Trekboer* type GET SPIDER, then put the spider in the room where the plant is. Type GET PLANT and leave the room. Press the button; this should take care of the second spider.

• Phil Derksen: In *Planetfall*, to get the key, try using the bar. It's "magnetic."

How do you get past the stone gargoyle in *Raaka-Tu*? How do you get past the rug? Is there any way past the gates on the west wall? Are there any other secret passages other than under the altar? What do I do when I leave the secret passage under the altar?

Jim Price
Penetanguishene, Ontario

Scoreboard:

In *Dungeons of Daggorath*, the fastest

way to get your shots in is to have your sword in your left hand. That way, you can put your left index finger on the A key, your right thumb on the space bar, your right index finger on the L key and your right middle finger on the ENTER key. Now you can "roll" your hands and fill the buffer up with "AL," short for "Attack Left." Once you have the ring on the first level, type I FIRE to get the power of it. Then save it for Level 2.

How do you get ice out of rime? What exactly is the strategy to get the wizard's image on level three and what do the Wraiths and Galdrogs sound and look like?

James Wilcox
Rockland, ME

Scoreboard:

I have killed the wizard's image in *Dungeons of Daggorath*, and after that I'm transported to the fourth level with the things I had in my hands and the torch I'm using. Everything else disappears. The wizard's image also leaves a scroll. How do I get all my stuff back and the scroll?

Mark Fernandez
N. Dartmouth, MA

Scoreboard:

In *Dungeons of Daggorath*, on Level 2, how do you kill the evil knight and how do you get to all six levels? Can you climb up the ladder or can you just climb down? How do you use the rings?

Mike Walter
Wilmington, NC

Scoreboard:

In *Sands of Egypt*, to get the magnifier you must go south from the bottom of the cliff and dig. How do I get the torch and the container? How do I get the palm fronds?

Joe Martinez
Pullman, WA

Scoreboard:

In *Dallas Quest*, to get by the natives, type WAVE RING. Once you've killed the spider, put the ring in the statue's eye and something will fall out of the statue's mouth.

In *Pyramid*, where is the sarcophagus? In *Shenanigans*, where is the pocket knife? In *Sands of Egypt*, where is the torch?

Jaan Laansoo
Barrie, Ontario

Scoreboard:

In *Dallas Quest*, how do you get past the dinghy boat and get on it? When you do get past it, what do you do?

In *One-On-One*, how do you shatter the backboard and get three points?

Stephen Wallis
Beverly, MA

Scoreboard:

In *Sea Quest*, supposedly you have to go east from the stairs, dig and get the mirror. But when I try to dig, it says, "With my hands? Surely you jest!"

In *Calixto Island*, when you get to a place with the tombstone and pagan idol, what do you do? What do you do when you get back to shore where the shack is?

In *Black Sanctum*, how do you know when the computer will all of a sudden take you to a strange place where your body feels paralyzed? What is the use of the woman's hair?

Timothy Bishop
Jacksonville, FL

Scoreboard:

In *Pyramid 2000*, water the plant and climb it. I read in "Scoreboard Pointers" that the scepter bridges a gap. Where is this gap? Where is the mummy's treasure chest?

In *Escape 2012*, how do you get out of the alien base and how do you build the bomb?

In *Sam Sleuth P.I.*, how do you solve the bank robbery?

Philip Manwarren
Harrington, ME

Scoreboard:

In *Pyramid 2000*, how do you give the little plant water?

In *Madness and the Minotaur*, how do you get the magic sword, spell book, truth or light ring?

Joe Szewczyk
Eagle River, WI

Scoreboard:

In *Robot Odyssey*, how do you get the ticket needed to get to the next level?

In *Wild West*, how do you dynamite without blowing yourself up?

In *Treasure of the Aztecs*, how do you get the rod out of the hut without getting speared?

In *Escape 2012*, how do you get past the guard droid?

Chad Presley
Luseland, Saskatchewan

Scoreboard:

To get past the bugblatter beast in *Hitchhiker's Guide to the Galaxy*, get the stone, put the towel on your head, carve Arthur Dent in the memorial and remove the towel.

In *Zork I*, the scepter will turn the rainbow into stairs.

In *Planetfall*, where is the radiation suit, and what do you do to the mural?

Ray Knoch
Lawson, MO

Scoreboard:

In *Hitchhiker's Guide to the Galaxy*, how do you kill the bugblatter beast of Traal, and how do you get past the screening door?

Richard Hawley
Honolulu, HI

Scoreboard:

In the *Interbank Incident*, I have found both keys, the rope, the computer, the disk, the cartridge, the transmitter and pipe, and the code book. But what do I do now?

Nick Rocco
Throop, PA

Scoreboard:

In *Vortex Factor*, how do I find the cartridge that takes me to London? How do I open the safe behind the calendar and how do I open the north doors? I have the red, yellow, pink and white cartridges.

Matt Buffalow
Walla Walla, WA

Scoreboard:

In *Raaka-Tu*, how do I get past the rug with the spiked pit?

Benoit St-Jean
Gatineau, Quebec

Scoreboard:

In *Raaka-Tu*, I cannot get by the gargoyle. I have found the coin, food, sword and the ring.

Troy Ferguson
Dease Lake, British Columbia

Scoreboard:

In *Madness and the Minotaur*, going south is the direction that almost always

leads to the maze, but is not the only direction that leads to the maze.

In *Rogue*, don't drink two potions of Haste Self in succession because a flaw in the game will cause the computer to lock up and you'll lose your game.

In *The Magic of Zanth*, how do you open the bottle?

In *Raaka-Tu*, what do you do after you've killed the gargoyle and the snake and found the secret passage that leads back to the outside of the temple?

Steve Moore
Ontario, CA

Scoreboard:

In *Shenanigans*, to get to the clover field, you must go to where the unicorn horn is. Go east until you see "Obvious exits are: north, south, east, west." Type EAST and you will be in the clover field.

In *Sea Quest*, to find the last treasure, go where the deflated balloon is and go east. When you have all your treasures, go to your cave and drop them.

In *Raaka-Tu*, how do you get over the rug and where do you finish this Adventure?

Benoit St-Jean
Gatineau, Quebec

Scoreboard:

In *Shenanigans*, how do you get past the ravine in the cave?

Andrew Bryan
Springhill, Nova Scotia

Scoreboard:

In *Gates of Delirium*, how do I get to the Shrines and where can I find people to join my party? What's in the dungeons?

Dan Breault
Chicopee, MA

Scoreboard:

How do you get past Chamber 8 in *Downland* without getting killed on the rope at the top of the screen?

Jim Barkel
Zeeland, MI

Scoreboard:

I can't get into the tunnel in *Black Beard's Island*. I know that you go up to the cliff and type MOVE SIGN and it reveals a hidden tunnel, but how do you get into the tunnel?

Keith Janas
Kitwanga, British Columbia

Scoreboard:

After I deactivate the laser bars in *Escape 2012*, I cannot seem to get past the guard. I type HELP, but that doesn't work.

Will Patterson
Jacksonville, FL

Scoreboard:

In *Double Back*, to get the most amount of available points, let the moving objects, such as the magnets, move around the board until they build into one object. Then, circle them all at once. This will double the score for each object there.

Don Mullis
Delavan, WI

Scoreboard:

In *Gold Runner*, how do you get past Level 19? I have yet to find a way to collect the gold in the center block wall and then get out!

Monte Napper
Houston, TX

Scoreboard:

To all *Caladuril Flame of Light* players:

More thorough research into the chronicles scribed at the time of Jayen Tarinson and his adventures revealed two enigmatic verses apparently written by previous foes of Silmnoleh, Darker Lord of Fire.

The first pertains to "playces undergrounde," and reads as follows:

You're stuck at a door, too bad!
Your're stuck at a door, too right!
But don't you give up too soon,
There may be illusion, to right!

The second was found, we have discovered, scrawled on the wall of an iron castle:

Drop it near the dimmering depths.
You'll need it if you pass the steps.
But you can't take it when you go,
That wooden shield that aids you so.

Our own research has failed to reveal the meanings of these two verses; we publish them here in the hope they will aid other, braver Adventurers.

Jeff Noyle
Dave Triggerson
Georgetown, Ontario

To respond to other readers' inquiries and requests for assistance, reply to "Scoreboard Pointers," c/o THE RAINBOW, P.O. Box 385, Prospect, KY 40059. We will immediately forward your letter to the original respondent and, just as importantly, we'll share your reply with all "Scoreboard" readers in an upcoming issue.

For greater convenience, "Scoreboard Pointers" and requests for assistance may also be sent to us through the MAIL section of our Delphi CoCo SIG. From the CoCo SIG> prompt, pick MAIL, then type SEND and address to: EDITORS. Be sure to include your complete name and address.

Last month, we had a lot of fun with Lo-Res graphics borders. It was an enjoyable session. For an encore, I decided to continue our exploratory trip to see where this extended lesson would lead us.

From past experience, I know that the trail will peter out and we will get mired down in a CoCo swamp that has oodles of dead ends. The fun is in the journey and the computer flora and fauna that we check out along the way.

We pretended we were a bunch of CoConauts, beginning our safari through the tangle of BASIC jungle lore. Now that we are veteran border-makers, load MARQUEE1, which last month you were invited to save.

The first idea perking away is of a double border. How to proceed? Start with a second row at the top. Type this line:

```
71 'FOR H=2 TO 61 STEP2:SET
(H,2,C):NEXTH
```

Note the temporary masking REM (').

Because a border exists around the perimeter of our screen (that is, two graphics units wide), instead of starting at H=0, we begin at H=2. Instead of ending at H=62, we allow for the right side border and stop at H=61. Since we used two vertical units, 0 and 1, for the top row, we type V=2.

H has shrunk two units at each side and V is pushed down two units. By now, you must have a sneaking suspicion that each graphics square is really a 2-by-2 square. Run. It is evident that the lines we called forth display one colored space and one blank (black) space, racing around the perimeter. The other two spaces, on the second row, are also blank, creating the illusion of a solid, inner border.

As an aside, to fill the first two lines of the top border, we require a nested loop. Rekey Line 70 and run:

```
70 FOR H=0 TO 63:FOR V=0 TO
1:SET(H,V,B):NEXTV,H
```

The inner loop is gone through first, then the outer loop: H=0,V=0;H=0,V

Florida-based Joseph Kolar is a veteran writer and programmer who specializes in introducing beginners to the powers of the Color Computer.

*When you're bogged
down in the CoCo
marshes . . .*

Swamp Think

**By Joseph Kolar
Rainbow Contributing Editor**

=1;H=1,V=0:H=1;V=1 . . . H=63,V=0;H=63;V=1. Run it again and watch it evolve. In the *next* part of the multiple-line statement, V is executed first. It is separated from H, the outer loop, by a comma. Rekey Line 70:

```
70 FOR H=0 TO 63:SET(H,0,B):
NEXTH:FOR V=0 TO 63:SET(H,
1,B):NEXTH
```

Run. Study it and you will see both orange lines become one husky one. Rekey Line 60 for a third way:

```
70 FORH=0TO63:SET(H,0,B):SET
(H,1,B):NEXTH
```

Run the program. To be honest, each method is as good as the next. Which system you select depends on the perspective you bring to CoColand.

Keep this information on tap. We don't want to pack it on at this stage of the journey. However, we may be looking for it later.

Restore the original Line 70:

```
70 FOR H=0TO63:STEP2:SET(H,
0,C):NEXTH
```

Edit Line 71 to get rid of the REM marker ('). Enter EDIT 71, press D (for Delete), then press ENTER. The line is now active! Run to see its effect.

Now, to get the inner, right side border segment doped out, we know

that we can work on H=61, and the vertical column can begin at V=2 and end at V=29. The V length has shrunk at both ends. Enter this line and run:

```
B1 FOR V=2TO29STEP2:SET(61,
V,C):NEXTV
```

Compare the paired lines, lines 70 and 71 and 80 and 81. This should suggest what shape Line 91 should take:

```
91 FORH=61TO2 STEP-2:SET(H,
29,C+1):NEXTH
```

Run, and note that C+1 was utilized to change colors.

At this point, create a suitable Line 101. Check listing TRIPLE for my version. Run.

My mind is intrigued with a third inner border. But, enough of two rows of colored light bulbs. I want the inner row to be a moving, colored neon tube.

Refer to TRIPLE, lines 72, 82, 92 and 102. Again, the FOR lines are compressed by two more units at each end. The other end decreases or increases by two, depending on the direction traveled. We are using STEP-1 when the FOR value is decreasing as it is executed. It is omitted in the ascending FOR values because STEP+1 (STEP1) is the default mode. If it makes more sense to you, be my guest, and include it in lines 72 and 82.

Key in the four lines and run.

A lot of jungle paths are tempting me. What about a STEP-3 variant? How about an outside STEP-1 border? How about a convoluted square working to the center of the screen? (Save TRIPLE now.)

Now convert the outer border, lines 70, 80, 90 and 100, so that they sandwich the light bulbs (middle row). Merely edit each of the four lines to STEP1 or STEP-1. For example, enter EDIT70 and press the space bar until the cursor is over the 2 of STEP2. Maybe we ought to make the third variable, denoting color, agree in the neon lines (C and C or C+1 and C+1). Run.

This variant is OK, but it lacks pizzazz. What if we checked the neon lines and made all C+1 variables into C variables? Run when ready. This version doesn't do anything for me.

Try this: Rekey Line 65 as 65 FOR C=1 TO RND(8) and run. This will run itself

out and display a fairly well-balanced, colored border. Line 65 could be written like this and produce the same result: 65 FOR C=RND(1) TO RND(8). Run the program.

Stop as you work along with me and save anything that suits your fancy. At this stage, I am changing Line 0 to 0 'TRIPLEA' and making a copy before I get lost.

Another trail to explore is that of making the light bulb row circulate in the opposite, counterclockwise direction. This involves lines 71, 81, 91 and 101. The FOR part of the line must be reversed, STEP+2 changed to STEP-2, and STEP-2 changed to STEP+2.

Restore Line 65 as 65 FOR C=1TO8 and run. Something is wrong! Now add the "title line" 0 'WACKY and save the program as WACKY, if you like. Can you see where I wandered down the primrose path?

I had to camp out in this dismal swampland and work out proper lines 71, 81, 91 and 101: Merely change Line 81 to 101 and 101 to 81. Change C+1 to C in lines 81 and 91. All the color-set values will be the same. Line 66 should now be inoperative. Mask it and run to see if this is true. The program goes into a dizzying perpetual loop when it hits orange, Color 8. As it stands, the display is no earth-shatterer.

For variety, let's turn the outer border into a light bulb border. Change the four 1s to 2s in the STEP, lines 70, 80, 90 and 100. Run. This, too, poops out with an orange border.

Suppose the outer border were STEP-3 or +3? Try it! Run it! Give it a title line: 0 'WACKYA.

You can put these few programs into perpetual color recycling.

Edit Line 200 by entering EDIT200. Press X to jump to the end of the line, then backspace three characters. Type

65, press ENTER, and run. Easier still, rekey Line 200 as 200 GOTO 65 and run.

What if the light bulb (middle row) were changed to a neon sign and the inner one changed to a STEP 3 to complement the outside row?

First, change the four STEP2 or -2 commands in lines 71, 81, 91 and 101 to STEP+1 or -1, and run. That's not too bad — do you see how I am getting more and more ideas and am side-tracked from exploring other paths pregnant with possibilities?

Remember that routine with a double, solid orange row that we set aside as boring? What if we set the outer border to a nice wide band of living color?

Enter EDIT70 and press the space bar until the cursor is over the S in STEP. Type 5D (to delete STEP and the space), press I (for Insert) and type :FOR V=0TO1: . Press a shifted up arrow to get out of the Insert mode, and advance the space bar until the cursor is over the C. Press C (for Change) and replace the letter by pressing V. Then press the space bar until the cursor is over the final H. Press I, type V, press ENTER and run.

Edit Line 80 by entering EDIT80. Advance the space bar until the cursor is over the S in STEP. Type 6D (to delete six characters) and press I (for Insert). Type :FOR H=62 TO 63 and press a shifted up arrow to get out of the Insert mode. Advance the space bar until the cursor is over the 6 in 63. Press D (for Delete), C (for Change) and H, and advance the space bar until the cursor is over the final V. Press I, type H, press ENTER and run.

At this point, it begins to dawn on me that it might be wiser to execute the outer frame completely, then the middle frame and, finally, the inner frame.

I leave it to you to edit lines 90 and

100. This is designed to give you much-needed practice. Unmask Line 65 (remove the REM marker). Finally, change C to C+1 in lines 70, 80, 90 and 100. In the unlikely event that you get hung up, refer to listing WACKYB.

On one of my meandering treks, I modified TRIPLE. See TRIPLEA. This has two rows of light bulbs with an inner neon sign. Compare each triplet (lines 70 to 72, 80 to 82, etc.). Can you spot the camouflaged changes? Note that the numeral variable in the SET statement in lines 72 and 102 was a 5 instead of the expected 4; in Line 82, 58 instead of 59; and in Line 92, 26 instead of 27. This gives a colored (as opposed to black) inner border segment. Why is this so?

I am dead-ending in cul-de-sacs on all trails that intrigued me. However, I want to try to make a convoluted STEP2;STEP-2 border that ends up in the middle of the screen. I will start you off on this insane race to nowhere.

In listing TRIPLE1, delete some lines by typing the following: DEL71-72, DEL81-82, DEL91-92 and DEL101-102. Run.

Edit Line 100, advancing the space bar until the cursor is over the first 0. Press C, type 2, press ENTER, and run. Enter RENUM 400,110,10 to renumber the lines, and add these lines:

```
110 FOR H=2 TO 61 STEP2:SET
(H,2,C):NEXTH
120 FOR V=2 TO 29 STEP2:SET
(59,V,C):NEXTV
130 FOR H=59 TO 2 STEP-2:SET
(H,29,C):NEXTH
140 FOR V=27 TO 4 STEP-2:SET
(4,V,C):NEXTV
150 FOR H=4 TO 49 STEP2:SET
(H,4,C):NEXTH
```

... and so forth.

THE BEST COCO ASSEMBLY LANGUAGE PROGRAMMING BOOKS IN PRINT

"Assembly Language Programming for the CoCo" (The Book) and the CoCo 3 (The Addendum). Professionally produced (not just skimpy technical specifications). THE CoCo reference books.

THE BOOK - 289 pages of teaching assembly language for the CoCo 1 & 2. It's used as a school text and is an intro to Computer Science. It describes the 6809E instructions, subroutines, interrupts, stacks, programming philosophy, and many examples. Also covered are PIAs, VDG, SAM, kybd, jystk, sound, serial port, and using cassette and disk. \$18.00 + \$1.50 s/h.

THE ADDENDUM - Picks up where the BOOK left off. Describes ALL the CoCo 3 enhancements & how to use them with assembly language. The most complete GIME spec. WOW - Super-Res Graphics (up to 1280 pixels across), Virtual Memory, Interrupts, and more information not available elsewhere. \$12.00 + \$1.00 s/h.

COCO 3 SPECIAL Start your CoCo library right. See what the CoCo can really do and save money - buy the BOOK and ADDENDUM for only \$27.00 + \$2.00 s/h.

US check or money order. RI orders add 6% sales tax

TEPCO
68 James Court
Portsmouth, RI 02871

See Us On DELPHI

If you want to see the imperfect program I created, key in SEASHELL. It has minor flaws; however, since we stumble over exposed roots now and then in our zealous explorations, we exhibit this prize spiral shell, flaws and all.

This is too bizarre for me. I checked all the lines from 70 to 370 and yanked out all the +1s from C+1 variables so that only one color would make its debut at a time. The central area is disturbing, due to the black area. Luckily, the ol' legend was intact. Add these lines and run:

```
251 NEXTC
252 GOTO65
```

Examine the specimen carefully and you will see that there are four light bulbs on the left side and five on the right, zipping around the legend.

Nothing can be satisfactorily adjusted in the rows five above and six below the light bulbs. To maintain the integrity of the three-line title, we must live with this sad state of affairs.

Can we support our legend by including Line 260 into CoCo's mindless race around the legend? We will never find out unless we try it.

Enter LIST-270 and DEL251-252 and 261 NEXTC:GOTO65 and run. Perfect! Now all that is required is to condense the three-text line legend one character-width, and thereby create a left green margin.

Enter LIST-60. Use the Edit mode to raise the TAB value by 1 in lines 30, 50 and 60. Run. Isn't that better? It is time to extract the three periods from the same lines. Do so, with Edit, and run.

Enter EDIT 0 and advance the space bar two spaces. Press H (for Hack) to chop off the title, type RACE and press ENTER. Enter LIST-70 to display the listing up to Line 70. Line 66 must go, as it isn't saying anything to CoCo. Enter DEL66 and run. Save your modification as RACE.

Note that unnecessary lines, 270 out, were not deleted. It costs nothing to include them in your save — and, who knows, we may want them later. With similar logic, rather than delete unused lines, you could consider making them passive with a REM marker. For the newcomer, this may be somewhat confusing. But as you get more time behind the keyboard, you will use REM religiously.

There are many, many ideas to investigate, and you will want to continue to wade through the swamp of the unknown, seeking more variants. I can think of many more.

Each mind is unique. You must have made many discoveries if you put forth the effort last month to explore on your own. If you did, note that a lot of jungle trails and variants you discovered are unlike the ones I found lurking in the dark recesses of my mind. That is as it should be!

As it is, there are so many vine-strewn

paths concealing fine variant programs, that you are urged to have RACE handy to continue our super-extended lesson in our next tutorial.

But, this is your day! Keep probing and you will add to your ever-increasing cache of knowledge and amuse yourself, to boot. And if you are running RACE, watch entranced as CoCo breathlessly scoots around the three-liner.

We have been bogged down in the very beginning of BASIC, using very few commands and statements. Even so, you have inspired me to create some neat graphics titles. I hope I have given you a slight push to explore more pathways. Consider how far we have advanced. Just last month we began by creating a blank PRINT line. You have progressed far, but not without setbacks. You have seen that we have barely cleared a small path in the Lo-Res part of BASIC. If we diligently pursue all of our ideas, will we ever get out of Color BASIC? So far, we have used only the EDIT command from Extended Color BASIC.

Next month, we will continue on our bogged-down swamp search. If you are confused with some facets of EDIT, refer to your manual, but rest assured that we shall provide more examples to give you lots of hands-on practice. Join me as we delve deeper into the swamp and seek out creative ideas. Even if we don't find the fountain of youth, we will have found a veritable fountain of valuable CoCo knowledge. □

Listing 1:

```
0 '<TRIPLE>
10 CLS
20 FOR X=1 TO 5:PRINT:NEXTX
30 PRINTTAB(9)"DOCHITA D. MAY"
40 PRINT
50 PRINTTAB(7)"510 HIGHLANDS AVE
."
60 PRINT:PRINTTAB(5)"INVERNESS,
FL., 32652"
65 FOR C=1 TO 8
66 IF C+1=9 THEN C=1
70 FOR H=0 TO 63STEP2:SET(H,0,C)
:NEXTH
71 FOR H=2 TO 61 STEP2:SET(H,2,C
+1):NEXTH
72 FOR H=4 TO 59:SET(H,4,C):NEXT
H
80 FOR V=0 TO 31STEP+2:SET(63,V,
C+1):NEXTV
81 FOR V=2 TO 29STEP2:SET(61,V,C
):NEXTV
82 FOR V=4 TO 27:SET(59,V,C):NEX
```

```
TV
90 FOR H=63 TO 0 STEP-2:SET(H,31
,C):NEXTH
91 FOR H=61 TO 2 STEP-2:SET(H,29
,C+1):NEXTH
92 FOR H=59 TO 4STEP-1:SET(H,27,
C):NEXTH
100 FOR V=31 TO 0 STEP-2:SET(0,V
,C+1):NEXTV
101 FOR V=29 TO 2 STEP-2:SET(2,V
,C):NEXTV
102 FOR V=27 TO 4STEP-1:SET(4,V,
C):NEXTV
110 NEXTC
200 GOTO200
```

Listing 2:

```
0 '<TRIPLEA>
10 CLS
20 FOR X=1 TO 5:PRINT:NEXTX
30 PRINTTAB(9)"DOCHITA D. MAY"
40 PRINT
```

```

50 PRINTTAB(7)"510 HIGHLANDS AVE
."
60 PRINT:PRINTTAB(5)"INVERNESS,
FL., 32652"
65 FOR C=RND(1) TO RND(8)
66 IF C+1=9 THEN C=1
70 FOR H=0 TO 63STEP1:SET(H,0,C)
:NEXTH
71 FOR H=2 TO 61 STEP2:SET(H,2,C
+1):NEXTH
72 FOR H=4 TO 59:SET(H,4,C):NEXT
H
80 FOR V=0 TO 31STEP+1:SET(63,V,
C):NEXTV
81 FOR V=2 TO 29STEP2:SET(61,V,C
):NEXTV
82 FOR V=4 TO 27:SET(59,V,C):NEX
TV
90 FOR H=63 TO 0 STEP-1:SET(H,31
,C):NEXTH
91 FOR H=61 TO 2 STEP-2:SET(H,29
,C+1):NEXTH
92 FOR H=59 TO 4STEP-1:SET(H,27,
C):NEXTH
100 FOR V=31 TO 0 STEP-1:SET(0,V
,C):NEXTV
101 FOR V=29 TO 2 STEP-2:SET(2,V
,C):NEXTV
102 FOR V=27 TO 4STEP-1:SET(4,V,
C):NEXTV
110 NEXTC
200 GOTO200

```

```

,C):NEXTH
92 FOR H=59 TO 4STEP-1:SET(H,27,
C):NEXTH
100 FOR V=31 TO 0 STEP-3:SET(0,V
,C):NEXTV
101 FOR V=29 TO 2 STEP-2:SET(61,
V,C):NEXTV
102 FOR V=27 TO 4STEP-1:SET(4,V,
C):NEXTV
110 NEXTC
200 GOTO200

```

Listing 4:

```

0 '<WACKYB>
10 CLS
20 FOR X=1 TO 5:PRINT:NEXTX
30 PRINTTAB(9)"DOCHITA D. MAY"
40 PRINT
50 PRINTTAB(7)"510 HIGHLANDS AVE
."
60 PRINT:PRINTTAB(5)"INVERNESS,
FL., 32652"
65 FOR C=1 TO 8
66 IF C+1=9 THEN C=1
70 FOR H=0 TO 63:FORV=0 TO 1::SE
T(H,V,C+1):NEXTV,H
71 FOR H=61TO 2 STEP-1:SET(H,2,C
):NEXTH

```

Listing 3:

```

0 '<WACKYA>
10 CLS
20 FOR X=1 TO 5:PRINT:NEXTX
30 PRINTTAB(9)"DOCHITA D. MAY"
40 PRINT
50 PRINTTAB(7)"510 HIGHLANDS AVE
."
60 PRINT:PRINTTAB(5)"INVERNESS,
FL., 32652"
65 FOR C=1 TO 8
66 'IF C+1=9 THEN C=1
70 FOR H=0 TO 63STEP3:SET(H,0,C)
:NEXTH
71 FOR H=61TO 2 STEP-2:SET(H,2,C
):NEXTH
72 FOR H=4 TO 59:SET(H,4,C):NEXT
H
80 FOR V=0 TO 31STEP+3:SET(63,V,
C):NEXTV
81 FOR V=2 TO 29 STEP+2:SET(2,V,
C):NEXTV
82 FOR V=4 TO 27:SET(59,V,C):NEX
TV
90 FOR H=63 TO 0 STEP-3:SET(H,31
,C):NEXTH
91 FOR H=2 TO 61 STEP+2:SET(H,29

```

INTRODUCING THE
WARGAME DESIGNER



TAKE COMMAND! Now you can create your own 1 & 2 player wargames and more. If you are into wargames, science fiction or Dungeons and dragons, you'll love the WGD system.

The completely menu driven system allows you to create your own full color Hi-res icons for units and map features. Take control of the number of units, strength, movement, turn of entry, range of fire, terrain modifiers and objectives. No programming required! WGD comes with a 23 page manual and 2 floppy diskettes in a rigid vinyl case with these four ready to play scenarios:

INVASION NORTH	a river crossing challenge
ATTACK ON MOSCOW	a historic simulation 1941
ROBOT COMMAND	a sci-fi thriller
DUNGEON WARRIOR	save the damsel in distress



Complete WGD system ONLY \$29.00 Each scenario available separately with WGD system demo for ONLY \$10.00.
COCO 3 128K Disk

GRIDIRON STRATEGY



The FIRST and still the BEST 2 player football strategy game for the COCO 3 128K disk.

Over 20 offensive plays and 10 defensive alignments. See the RAINBOW review 8/87. '...fascinating.' Totally unique playing system!

Disk, manual and playing aids only \$21.00.



\$\$\$\$\$\$\$\$\$ WEEKLY WINNER 2.0 \$\$\$\$\$\$\$\$\$\$

A graphics oriented PROVEN WINNER! Features statistical analysis, intuition and luck. Manual contains little known facts about winning number characteristics. Works with all state lotteries, all number combinations.

'I won \$90.00 the first time I used it.' KJO, OH
ONLY \$10.00

Orders shipped first class FREE within 24 hours of receipt. ORDER TODAY!

SPORTSware 1251 S. Reynolds Rd., Suite 414, Toledo, OH 43615



(419) 389-1515



```

72 FOR H=4 TO 59:SET(H,4,C):NEXT
H
80 FOR V=0 TO 31:FOR H=62 TO 63:
SET(H,V,C+1):NEXTH,V
81 FOR V=2 TO 29 STEP+1:SET(2,V,
C):NEXTV
82 FOR V=4 TO 27:SET(59,V,C):NEX
TV
90 FOR H=63 TO 0STEP-1:FORV=30 T
O 31:SET(H,V,C+1):NEXTV,H
91 FOR H=2 TO 61 STEP+1:SET(H,29
,C):NEXTH
92 FOR H=59 TO 4STEP-1:SET(H,27,
C):NEXTH
100 FOR H=0 TO 1:FOR V=31 TO 0 S
TEP-1:SET(H,V,C+1):NEXTV,H
101 FOR V=29 TO 2 STEP-1:SET(61,
V,C):NEXTV
102 FOR V=27 TO 4STEP-1:SET(4,V,
C):NEXTV
110 NEXTC
200 GOTO65

```

```

200 FOR V=6TO25 STEP2:SET(57,V,C
):NEXTV
210 FOR H=55 TO 6 STEP-2:SET(H,2
5,C):NEXTH
220 FOR V=23 TO6 STEP-2:SET(6,V,
C+1):NEXTV
230 FOR H=8TO55STEP2:SET(H,8,C):
NEXTH
240 FOR V=8 TO23 STEP2:SET(55,V,
C):NEXTV
250 FOR H=53 TO8STEP-2:SET(H,23,
C):NEXTH
260 FOR V=21 TO 8STEP-2:SET(8,V,
C+1):NEXTV
270 FORH=10TO53STEP2:SET(H,10,C)
:NEXTH
280 FOR V=10 TO21STEP2:SET(53,V,
C):NEXTV
290 FOR H=51 TO10STEP-2:SET(H,21
,C):NEXTH
300 FOR V=19 TO 12STEP-2:SET(10,
V,C+1):NEXTV
310 FORH=12 TO51 STEP2:SET(H,12,
C):NEXTH
320 FOR V=12 TO19 STEP2:SET(51,V
,C):NEXTV
330 FORH=49 TO12 STEP-2:SET(H,19
,C):NEXTH
340 FOR V=17 TO14 STEP-2:SET(12,
V,C+1):NEXTV
350 FORH=14TO49STEP2:SET(H,14,C)
:NEXTH
360 SET(49,16,C)
370 FOR H=47 TO14STEP-2:SET(H,16
,C):NEXTH
400 NEXTC
410 GOTO410

```

Listing 5:

```

0 '<SEASHELL>
10 CLS
20 FOR X=1 TO 5:PRINT:NEXTX
30 PRINTTAB(9)"DOCHITA D. MAY"
40 PRINT
50 PRINTTAB(7)"510 HIGHLANDS AVE
."
60 PRINT:PRINTTAB(5)"INVERNESS,
FL., 32652"
65 FOR C=1 TO 8
66 IF C+1=9 THEN C=1
70 FOR H=0 TO 63STEP2:SET(H,0,C)
:NEXTH
80 FOR V=0 TO 31STEP+2:SET(63,V,
C+1):NEXTV
90 FOR H=63 TO 0 STEP-2:SET(H,31
,C):NEXTH
100 FOR V=31 TO 2 STEP-2:SET(0,V
,C+1):NEXTV
110 FOR H=2 TO 61 STEP2:SET(H,2,
C):NEXTH
120 FOR V=2 TO 29 STEP2:SET(61,V
,C):NEXTV
130 FOR H=59 TO 2 STEP-2:SET(H,2
9,C):NEXTH
140 FOR V=27 TO 4 STEP-2:SET(2,V
,C+1):NEXTV
150 FOR H=4TO59 STEP2:SET(H,4,C)
:NEXTH
160 FOR V=4TO27 STEP2:SET(59,V,C)
):NEXTV
170 FOR H=57 TO4STEP-2:SET(H,27,
C):NEXTH
180 FOR V=25 TO 6 STEP-2:SET(4,V
,C+1):NEXTV
190 FOR H=6TO57 STEP2:SET(H,6,C)
:NEXTH

```

Listing 6:

```

0 '<RACE>
10 CLS
20 FOR X=1 TO 5:PRINT:NEXTX
30 PRINTTAB(10)"DOCHITA D MAY"
40 PRINT
50 PRINTTAB(8)"510 HIGHLANDS AVE
"
60 PRINT:PRINTTAB(6)"INVERNESS,
FL, 32652
65 FOR C=1 TO 8
70 FOR H=0 TO 63STEP2:SET(H,0,C)
:NEXTH
80 FOR V=0 TO 31STEP+2:SET(63,V,
C):NEXTV
90 FOR H=63 TO 0 STEP-2:SET(H,31
,C):NEXTH
100 FOR V=31 TO 2 STEP-2:SET(0,V
,C):NEXTV
110 FOR H=2 TO 61 STEP2:SET(H,2,
C):NEXTH
120 FOR V=2 TO 29 STEP2:SET(61,V

```

,C):NEXTV
 13Ø FOR H=59 TO 2 STEP-2:SET(H,2
 9,C):NEXTH
 14Ø FOR V=27 TO 4 STEP-2:SET(2,V
 ,C):NEXTV
 15Ø FOR H=4TO59 STEP2:SET(H,4,C)
 :NEXTH
 16Ø FOR V=4TO27 STEP2:SET(59,V,C
):NEXTV
 17Ø FOR H=57 TO4STEP-2:SET(H,27,
 C):NEXTH
 18Ø FOR V=25 TO 6 STEP-2:SET(4,V
 ,C):NEXTV
 19Ø FOR H=6TO57 STEP2:SET(H,6,C)
 :NEXTH
 20Ø FOR V=6TO25 STEP2:SET(57,V,C
):NEXTV
 21Ø FOR H=55 TO 6 STEP-2:SET(H,2
 5,C):NEXTH
 22Ø FOR V=23 TO6 STEP-2:SET(6,V,
 C):NEXTV
 23Ø FOR H=8TO55STEP2:SET(H,8,C):
 NEXTH
 24Ø FOR V=8 TO23 STEP2:SET(55,V,
 C):NEXTV
 25Ø FOR H=53 TO8STEP-2:SET(H,23,
 C):NEXTH

26Ø FOR V=21 TO 8STEP-2:SET(8,V,
 C):NEXTV
 261 NEXTC:GOTO65
 27Ø FORH=1ØTO53STEP2:SET(H,1Ø,C)
 :NEXTH
 28Ø FOR V=1Ø TO21STEP2:SET(53,V,
 C):NEXTV
 29Ø FOR H=51 TO1ØSTEP-2:SET(H,21
 ,C):NEXTH
 30Ø FOR V=19 TO 12STEP-2:SET(1Ø,
 V,C):NEXTV
 31Ø FORH=12 TO51 STEP2:SET(H,12,
 C):NEXTH
 32Ø FOR V=12 TO19 STEP2:SET(51,V
 ,C):NEXTV
 33Ø FORH=49 TO12 STEP-2:SET(H,19
 ,C):NEXTH
 34Ø FOR V=17 TO14 STEP-2:SET(12,
 V,C):NEXTV
 35Ø FORH=14TO49STEP2:SET(H,14,C)
 :NEXTH
 36Ø SET(49,16,C)
 37Ø FOR H=47 TO14STEP-2:SET(H,16
 ,C):NEXTH
 40Ø NEXTC
 41Ø GOTO41Ø

SPECIAL DEAL ON 500 PROGRAMS IS BACK!

BACK BY POPULAR DEMAND! GET OUR LATEST 50 DISKS OR TAPES FULL OF OVER 500 PROGRAMS. HERE IS WHAT YOU'LL RECEIVE:

- ★Over 250 Utility/Home Application Programs including a Word Processor, Database, Spreadsheet, Disk Utilities, Business Software, Electronics Series, Educational Programs for Kids, plus much more!
- ★Over 200 exciting games including King Pede, Kron, Star Trek, Flight Simulator, Wizard, Horse Races, Football, plus much more.
- ★Over 30 adventures including Rambo, Haunted House, Power Sword, Skid Row, plus 32k graphic adventures.

Individual issues sell for \$9⁰⁰ each or \$450⁰⁰ for all 50. We slashed the price to only \$150⁰⁰!

REG. \$450

NOW

\$150⁰⁰

★★THIS MONTH ONLY★★

Buy this package of 500 programs and receive a free 6 month subscription.



RAINBOW
CERTIFICATION
SEAL

WARM UP TO OUR WINTER PRICES ON SUBSCRIPTION SOFTWARE

THERE IS NO BETTER WAY TO ENJOY THE WINTER THAN TREATING YOUR COLOR COMPUTER TO 10 READY-TO-RUN PROGRAMS EACH MONTH. GET 12 DISKS OR TAPES A YEAR CONTAINING OVER 120 QUALITY PROGRAMS. A SUBSCRIPTION TO T & D SOFTWARE CONSISTS OF 10 READY-TO-LOAD PROGRAMS DELIVERED BY FIRST CLASS MAIL EVERY MONTH.

NO, WE ARE NOT THE SAME AS THE RAINBOW ON TAPE. IN FACT, MANY SUBSCRIBERS HAVE WRITTEN IN AND SAID THAT WE ARE MUCH BETTER THAN RAINBOW ON TAPE!



PRICES

	TAPE	THIS MONTH ONLY
1 YEAR (12 issues)	70.00	60.00
6 MO. (6 issues)	40.00	35.00
1 ISSUE	9.00	8.00

Michigan Residents Add 4%
 Overseas Add \$10 to Subscription Price
 Personal Checks Welcome!

- ★ Available on COCO 1, 2, and 3
- ★ Includes Documentation
- ★ Over 4,500 Satisfied Customers
- ★ Back Issues Available From July '82 (Over 670 Programs)

TURN TO PAGE 186 & 187 FOR A COMPLETE LISTING



PLEASE SPECIFY TAPE OR DISK

T & D SUBSCRIPTION SOFTWARE, 2490 MILES STANDISH DR., HOLLAND, MI 49424 (616) 399-9648



This month's program presents a language-arts review of synonyms, homonyms and antonyms. It can be used for almost any age student, but is designed mainly for elementary and middle-graders.

Synonyms are words that have the same meaning. Homonyms are words that sound exactly the same but are spelled differently and have different meanings. Antonyms are words that have opposite meanings.

Two words are presented on the screen at one time. The student's task is to decide whether the words are:

1. synonyms
2. homonyms
3. antonyms
4. unrelated and therefore none of the other choices.

There are 40 word pairs in the DATA lines. Each line contains the two words to be evaluated, followed by a comma and then the correct number of the answer to be pressed. As long as the format remains consistent, you may have as many DATA lines as you wish to include in your version of this program.

The computer keeps track of the number of word pairs that are included in the program by the variable N used on Line 30. Be certain to change the value of this variable if you should decide to alter the number of DATA lines.

The words selected by us are, for the most part, on an upper-elementary reading level. This was really an arbitrary choice and can be exchanged for any other level that suits your needs. You may type in your own vocabulary words instead of ours when you key in the DATA statements.

An interesting idea is to use data that includes words from the child's current spelling or vocabulary word lists. New lists can be added to the existing program or saved as programs of their own. You may, for example, save many copies of this program, each with a different set of data. Only the new data needs to be keyed in when you are proceeding in this manner. Be sure to

Steve Blyn teaches both exceptional and gifted children, holds two master's degrees and has won awards for the design of programs to aid the handicapped. He owns Computer Island and lives in Staten Island, New York.

*A review of synonyms,
homonyms and antonyms*

Differences and Similarities

By Steve Blyn
Rainbow Contributing Editor

save each new version with a name different from any of the previous versions.

Lines 30-70 have the computer read all of the data at the end of the program. Lines 80-190 print a random pair of words on the screen as well as the four choices. Lines 200-240 evaluate the student's answer. If an incorrect answer is given, the correct answer is displayed on the screen.

After each question is answered, the student may either press ENTER to go on or E to end the program. When the program is concluded, a score will be given. The computer constantly keeps track of the score. Each time a new example is given, the counter on Line 80 is increased by one; this is variable X. Each time a correct answer is given, the computer increases the counter on Line 230; this is variable C. The score is computed on Line 270. The formula used is $C/X*100$.

We hope you and your youngsters enjoy this program. We at Computer Island are always happy to learn of your uses of the programs appearing in this column. □

The listing: NYMS

```

10 REM"REVIEW OF SYNONYMS-HOMONY
MS-ANTONYMS"
20 REM"STEVE BLYN,COMPUTER ISLAN
D,STATEN ISLAND,NY,1988"
30 N=40
40 DIM A$(N),A(N)
50 P$=STRING$(32,191)
60 FOR T=1 TO N
70 READ A$(T),A(T):NEXT T
80 CLS:X=X+1
90 PRINT@2,"homonyms-antonyms-sy
nonyms";
100 PRINT@64,P$
110 R=RND(N)
120 PRINT@98,A$(R)
130 PRINT@128,P$
140 PRINT@160,"1.BOTH ARE SYNONY
MS"
150 PRINT@196,"2.BOTH ARE HOMONY
MS"
160 PRINT@232,"3.BOTH ARE ANTONY
MS"
170 PRINT@268,"4.NONE OF THE ABO
VE"
180 PRINT@288,P$
190 PRINT@321,"WHICH TYPE ARE TH
ESE WORDS? ";
200 EN$=INKEY$

```

```

21Ø IF EN$="1" OR EN$="2" OR EN$
="3" OR EN$="4" THEN 22Ø ELSE 2Ø
Ø
22Ø PRINTEN$
23Ø IF VAL(EN$)=A(R) THEN PRINT@
395,"CORRECT":C=C+1:GOTO 25Ø
24Ø PRINT@389,"SORRY, THE ANSWER
IS";A(R)
25Ø PRINT@454,"PRESS ENTER TO GO
ON";
26Ø AN$=INKEY$
27Ø IF AN$=CHR$(13) THEN 8Ø ELSE
IF AN$="E" THEN 28Ø ELSE 26Ø
28Ø PRINT@452,"YOUR FINAL SCORE
IS";INT(C/X*1ØØ);"%":END
29Ø DATA COARSE-COURSE,2
3ØØ DATA METE-MEET,2
31Ø DATA SCENT-CENT,2
32Ø DATA HAPPY-JOYOUS,1
33Ø DATA NICHE-NOOK,1
34Ø DATA NOOK-KNOCK,4
35Ø DATA PARE-PEAR,2
36Ø DATA KNIGHT-AFTERNOON,4
37Ø DATA SLIM-THIN,1
38Ø DATA SNEER-FROWN,1
39Ø DATA STEAK-STAKE,2
4ØØ DATA SITE-CITE,2
41Ø DATA REIN-REIGN,2
42Ø DATA THEIR-THOSE,4

```

```

43Ø DATA FOR-FOUR,2
44Ø DATA THEIR-THERE,2
45Ø DATA THERE-HERE,3
46Ø DATA DIRTY-SPOTLESS,3
47Ø DATA COLD-FRIGID,1
48Ø DATA FRIGID-WARM,3
49Ø DATA ICY-FRIGID,1
5ØØ DATA FRIGID-RIGID,4
51Ø DATA OPEN-SHUT,3
52Ø DATA SHUT-SHOOT,4
53Ø DATA SHOOT-CHUTE,2
54Ø DATA BEACH-BIRCH,4
55Ø DATA BEACH-BEECH,2
56Ø DATA SECURE-SAFE,1
57Ø DATA LEAVE-EXIT,1
58Ø DATA LEAVE-LIVE,4
59Ø DATA KING-SOVEREIGN,1
6ØØ DATA KING-PEASANT,3
61Ø DATA SOVEREIGN-PEASANT,3
62Ø DATA KING-RING,4
63Ø DATA ROUGH-SMOOTH,3
64Ø DATA ROUGH-SLEEK,3
65Ø DATA SLEEK-SMOOTH,1
66Ø DATA UNFAILING-CERTAIN,1
67Ø DATA AMBITIOUS-LAZY,3
68Ø DATA INDUSTRIOUS-LAZY,3
69Ø DATA AMBITIOUS-INDUSTRIOUS,1
7ØØ DATA HARMFUL-HARMLESS,3

```

1988 -- The Year of the Hard Disk!

The CoCo XT hard disk interface from **Burke & Burke** lets you connect up to 2 low cost, PC compatible 5-120 Megabyte capacity hard drives to your CoCo. You buy the drive, Western Digital WD1002-WX1 or WD1002-27X (RLL) controller, and a case from the PC dealer of your choice. Just plug them into the CoCo XT, plug the CoCo XT into your Multi-PAK, and you have a 20 Meg OS9 hard disk system for **under \$450!**

Great for multi-user systems! The CoCo XT interface uses advanced "NO HALT" hard disk controllers, which do not halt your CoCo and do not disable or use interrupts during hard disk access. You get full type-ahead, and the system clock does not lose time during hard disk access. Fully compatible with most RS-232 expansion ports!

CoCo XT (with anodized housing, 60 page user manual, hard disk back-up utility and new, Version 2.0 drivers for use with both OS9 & HYPER-I/O) -- \$69.95. Or choose the **CoCo XT-RTC** (includes real-time clock / calendar with battery backup) -- \$99.95

CoCo Immortality (and other wonders . . .)

Wouldn't it be nice if OS9 was just "there" whenever you turned on your computer? Wouldn't it be nice if your BBS or home control system would reboot **automatically** after a power failure?

Have you ever wished you could store two **different** OS9 boot files on your hard disk -- one for running games, another for normal operation?

Your CoCo can work these and other wonders if you install Burke & Burke's **XT-ROM** in your CoCo XT hard disk interface. XT-ROM automatically boots and reboots OS9 from your hard disk. Installs in the BIOS ROM socket of your hard disk controller -- \$19.95.

Announcing the Dynamic Disk Interface!

Got the 35-track floppy disk blues? Burke & Burke proudly presents **HYPER-I/O Version 2.0** -- the program that modifies the RS-DOS Disk BASIC in your CoCo 1, 2, or 3 to provide a "Dynamic Disk Interface". This program lets you use your existing BASIC and RS-DOS software with hard disk interfaces (such as the CoCo XT), RAM Disks, and any mix of floppy drives from 160K to 720K each. HYPER-I/O can even read standard disks in those quad-density, 160 track floppy drives. Fully RESET protected, user-configurable, expandable, OS9 compatible, EPROM-able HYPER-I/O may soon be THE RS-DOS enhancement of choice for the CoCo 1, CoCo 2, and CoCo 3!

HYPER-I/O (64K, includes 88 page user manual, BASIC & OS9 utilities) -- \$29.95

Access the full power of your machine! CoCo 3 owners can add a RAM Disk (512K only) and Print Spooler to HYPER-I/O with our HYPER-III package. Supports both parallel and serial printers (special driver required for parallel printer) **HYPER-III** -- \$19.95

OS9 Directory Assistants

WILD lets you use "wild cards" to specify groups of files instead of individual files with OS9's commands. You can even specify that a command be performed on an entire directory tree!

MV moves directory entries from place to place on your hard or floppy disks. MV may be safely used on OS9Boot, HYPER-I/O MSA's, and other special files as well as ordinary OS9 files and directories.

WILD & MV -- one disk, two great utilities, only \$19.95!

Don't miss the Chicago Rainbowfest for great deals and exciting new products from Burke & Burke!



Burke & Burke

P.O. Box 1283 Palatine, IL 60078-1283 (312) 397-2898



ILLINOIS RESIDENTS PLEASE ADD 7% SALES TAX. COD's add \$2.20. Shipping (within the USA) \$2.00 per CoCo XT; \$1.50 per disk or ROM. Please allow 2 weeks for delivery (overnight delivery also available for in-stock items). Telephone orders accepted (312) 397-2898.



NOVICES NICHE



THE RAINBOW is a teaching environment and we realize that the majority of our readers will always be beginners. In our continuing effort to always keep the new user in mind, and in addition to the many beginner feature articles and programs published in every issue, "Novices Niche" contains shorter BASIC program listings that entertain as well as help the new user gain expertise in all aspects of the Color Computer: graphics, music, games, utilities, education, programming, etc.

Cryptogram Contest Update

The response to April's Cryptogram Contest has been overwhelming to say the least, and we wish we could give everybody a copy of *The Third Rainbow Book of Adventures!* Due to the flood of entries we have already received, we cannot notify each cryptologist of the status of his or her entry, but be patient — the lucky winner and everyone else who decoded the message will receive a mention in an upcoming Novices Niche. Again, the deadline is May 1, and the drawing will be held on May 3.

Graphics

Non-Smoking Section

16K
ECB

By Ana M. Rodriguez

Keep your relationship healthy — computers don't like smoke, and neither do your lungs! The next time someone enters your computer room in a puff of smoke, banish him or her with this graphics program (point to the screen). If you have a printer and a screen dump capable of dumping a PMODE 3 graphic, you can make a printout to hang on your door.

The listing: NO SMOKE

```
1 REM **      NO SMOKING      **
2 REM **      BY              **
3 REM ** ANA M RODRIGUEZ **
10 PMODE3,1:PCLS:SCREEN 1,1
30 CIRCLE (128,96),100
40 CIRCLE (128,96),70
50 LINE (185,61)-(65,121),PSET
60 LINE (195,75)-(75,135),PSET
70 LINE (85,88)-(130,88),PSET
80 LINE (85,100)-(106,100),PSET
90 LINE (85,88)-(85,100),PSET
100 LINE (144,100)-(178,100),PSE
T
110 LINE (178,100)-(178,88),PSET
120 LINE (170,88)-(178,88),PSET
130 LINE (79,88)-(79,100),PSET
```

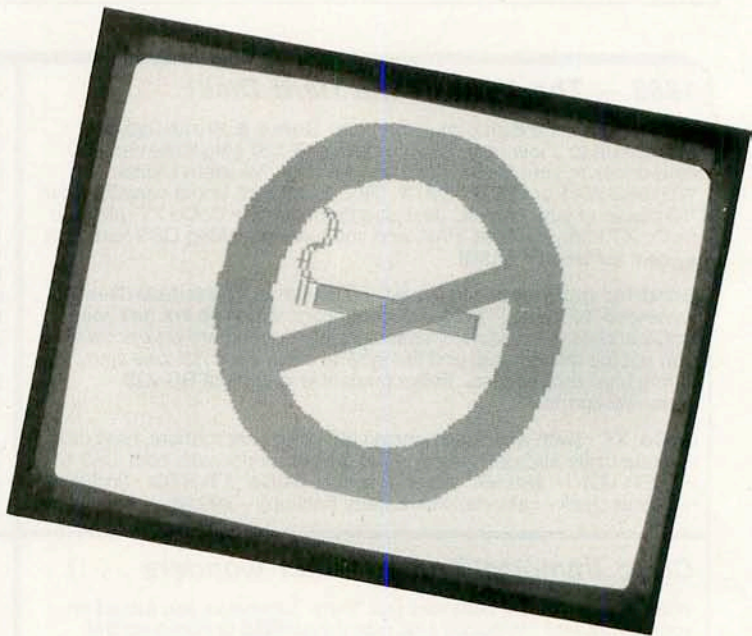

```
140 LINE (75,88)-(75,100),PSET
141 CIRCLE (83,78),12,,1,.30,.70
142 CIRCLE (75,60),12,,1,.80,.20
143 CIRCLE (87,78),12,,1,.30,.70
144 CIRCLE (79,60),12,,1,.80,.20
150 PAINT (128,20),0,0
160 PAINT (185,62),0,0
170 PAINT (86,90),3,0
180 PAINT (176,98),3,0
1000 GOTO 1000
```

CoCo 3 Canvas

CoCo 3

By George and Ellen Aftamonow

Turn your CoCo 3 screen into an easel for this graphics program, and watch as CoCo paints a path into modern art. The longer the program runs, the more colorful and diverse the "canvas" becomes. The program uses only three palettes but continually puts new colors into them.

The listing: CANVAS

```

10 'GEORGE AFTAMONOW
20 CLSRND(8):PRINT@233,"COCO3 CA
   NVAS";
30 FORT=1TO1000:NEXT
40 HSCREEN2
50 G1=RND(64)-1:PALETTE1,G1:G2=R
   ND(64)-1:PALETTE2,G1:G3=RND(64)-
   1:PALETTE3,G3
60 IFG1=G2 OR G1=G3 OR G2=G3 THE
   N50ELSEPALETTE2,G2
70 HCOLOR1,2
80 Z=RND(10)+1
90 FORX=1TO255STEPZ+2:Y=1:X1=1:Y

```

```

1=191-(X/1.5):HLINE(X,Y)-(X1,Y1+
RND(4)),PSET:NEXTX
100 FORX=1TO320STEPZ+2:X1=320:Y1
   =X/1.5:HLINE(X,Y)-(X1,Y1+RND(4))
   ,PSET:NEXTX
110 FORX1=255TO1STEP-Z-2:X=320:Y
   =191-X1/1.5:Y1=191:HLINE(X,Y)-(X
   1,Y1),PSET:NEXTX1
120 FORX1=320TO1STEP-Z-2:X=1:Y=X
   1/2.33:Y1=191:HLINE(X,Y)-(X1,Y1)
   ,PSET:NEXTX1
130 HCOLORRND(16)-1,RND(16)-1:HC
   IRCLE(160,96),R,3,RND(10)*.1
140 FORE=1TORND(9):X=RND(320):Y=
   RND(191):C=RND(9)-1:C1=RND(9)-1:
   HCOLORRND(9)-1,RND(9)-1:HCIRCLE(
   X,Y),RND(100),C,RND(10)*.1
150 HPAINT(X,Y),C1,C:NEXTE
160 FORX=1TO320STEPZ:HLINE(0,191)
   )-(X,0),PSET:NEXT
170 FORX=1TO320STEPZ:HLINE(320,0)
   )-(X,191),PSET:NEXT
180 FOREE=1TO10:PALETTE1,RND(64)
   -1:PALETTE2,RND(64)-1:PALETTE3,R
   ND(64)-1:NEXT
190 GOTO90

```

Printer

Ticket Maker

4K

By Ed Schenck

Has your club ever needed raffle tickets for a fund-raiser or tickets for entrance to a club-sponsored event? If so, then *Ticket* is for you. *Ticket* is adaptable for whatever type of tickets you need. The program prints tickets continuously due to a GOTO loop, so you'll need to press BREAK to stop. Delete Line 116 if you want to print only one ticket at a time.

The listing: TICKET

```

1 CLS
5 PRINT"*****"
10 PRINT"TICKET MAKER"
20 PRINT"BY ED SCHENCK"
25 PRINT"*****"
26 PRINT"PUT A SHEET OF PAPER IN
   YOUR PRINTER AND GET READY"
30 PRINT"WHAT WOULD YOU LIKE ON
   THE FIRST LINE?"
35 INPUT A$
40 PRINT"WHAT WOULD YOU LIKE ON
   YOUR SECOND LINE?"
45 INPUT B$
50 PRINT"WHAT WOULD YOU LIKE ON
   YOUR THIRD LINE?"
55 INPUT C$

```

CoCo Gallery Live Premiere
 Chicago RAINBOWfest May 20
 General Admission Ticket Required
 #-----

```

60 PRINT"WHAT WOULD YOU LIKE ON
   YOUR FOURTH LINE?"
65 INPUT D$
70 PRINT"WHAT WOULD YOU LIKE ON
   YOUR FIFTH LINE?"
75 INPUT E$
76 PRINT"THIS WILL PRINT CONTINU
   SLY."
77 PRINT"NOW PRINTING....."
80 PRINT#-2,A$
85 PRINT#-2,B$
90 PRINT#-2,C$
100 PRINT#-2,D$
110 PRINT#-2,E$
111 PRINT#-2,"#-----"
115 PRINT#-2,"-----"
   -----"
116 GOTO 80
120 PRINT"DONE!!!"

```

Graphics Reference Chart

By Daniel T. Weaver

4K

Tandy supplied me with the formula for figuring out graphics codes when I bought my CoCo, but I quickly got tired of plugging in variables and performing the mathematical functions. GRAFCODE made all those calculations unnecessary. Just run the program while your printer is online to create a handy reference chart. But watch your screen to see the graphics characters!

The listing: GRAFCODE

```
Ø PRINT#-2,TAB(6);"HANDY GRAPHIC
S CODE REFERENCE CHART":PRINT#-2
,TAB(6);"COLOR","+PATTERN","=COD
E#":'INSERT FANFOLD PAPER, TURN
ON PRINTER, BUT WATCH SCREEN!
1 FORC=1TO8:FORP=ØTO15:D=128+16*
(C-1)+P:PRINT"CODE#"D="CHR$(D)C
HR$(13):PRINT#-2,TAB(6);C,P,D:NE
XTP:NEXTC:PRINT#-2,TAB(6);"1=GRE
EN 2=YELLOW 3=BLUE 4=RED 5=BUFF
6=CYAN 7=MAGENTA 8=ORANGE":PRINT
#-2,TAB(6);"FOR PATTERNS CONSULT
COCO OWNER'S MANUAL"
```

A Full-Page Dump for the DMP-105

By John Handis

16K
ECB

I have written several screen dumps in BASIC, and they produced pixels at a one-to-one ratio. In other words, for every pixel on the screen, the printer would produce one dot on the page, which resulted in very small pictures. Also, the printer did not correct for the CoCo's irregularly shaped pixels — the printouts were coming out squashed. I tried sending pixels at larger ratios in order to get a larger picture, but sending code to the printer in anything but a one-to-one ratio requires resorting to machine language or massive calculations in BASIC.

Finally, the answer hit me. If the DMP-105 is put into its condensed character mode, there would be just enough room to do a dump using the block graphics codes (CHR\$ 224 to 239). The printout would fill an entire page, calculations would be cut way down, and there would be no reason to muddle around in the bit-image mode.

Obviously, nothing is perfect — this program does have its drawbacks. First, the dump is still pretty slow, taking about 15 to 20 minutes to do a PMODE 4 screen. The dump should work in any two-color PMODE as long as you change the PMODE value in Line 20, but it will not work in four-color modes. Also, the condensed blocks overcompensate for CoCo's irregularly shaped PMODE 4 pixels — now, instead of being squashed horizontally, they are squashed vertically! And another thing. According to the DMP-105 manual, graphics printing puts a strain on the print head. It suggests stopping every 1/6 page and giving the print head at least one minute's rest to keep it from overheating. If you are worried about overheating the print head, add this line, which will pause the printer for one minute every 1/6 page:

```
55 IF Y/22=INT(Y/22) AND Y>Ø THEN FOR K=Ø TO
36ØØ:NEXT
```

The listing: BIGDUMP

```
5 DIM C(15)
1Ø PRINT#-2,CHR$(27);CHR$(2Ø):'C
```



COMPRESSED MODE

```
2Ø PMODE4,1:SCREEN1,1:PRINT#-2,C
HR$(27);CHR$(28):'1/2 LINEFEED
3Ø FORC=ØTO15:READ C(C):NEXT
4Ø DATA 224,225,226,231,227,233,
23Ø,235,228,229,234,236,232,237,
238,239
45 PRINT#-2,CHR$(224);CHR$(224);
5Ø FORY=ØTO191STEP2:FORX=ØTO255S
TEP2
6Ø C=Ø
7Ø IF PPOINT(X,Y)=Ø THEN C=C+1
8Ø IF PPOINT(X+1,Y)=Ø THEN C=C+2
9Ø IF PPOINT(X,Y+1)=Ø THEN C=C+4
1ØØ IF PPOINT(X+1,Y+1)=Ø THEN C=
C+8
11Ø PRINT#-2,CHR$(C(C));:NEXT:PR
INT#-2,CHR$(13);CHR$(224);CHR$(
24);
12Ø NEXT
13Ø PRINT#-2,CHR$(27);CHR$(19):'
```

Utilities

Color in 32 Columns

By Chuck Katsekas

CoCo 3

Having luxuriated in 80 columns and all the possible combinations of color, do you CoCo 3 owners find yourselves nostalgically reminiscing about the good ol' days of 32-column CoCoing (when the eye strain was not as great)? Do you like being able to sit back — way back — and relax and still be able to read your screen without squinting? So what's keeping you squinting at 80 columns? Color — black on green just does not excite you.

Pal 32 is here to save your eyes. You can have your eye-soothing text and bask in the CoCo 3's palette of colors, too. Just run the program and answer the prompts for the desired foreground and background colors, and your eyes will thank you.

The listing: PAL32

```
10 '32 COLUMN PALETTE UTILITY
20 '(C) COPYRIGHT 1987
30 ' BY CHUCK KATSEKES
40 CLS
50 PRINT@0,STRING$(33,175)
60 PRINT@33,"32 COL. SCREEN PALETTE UTILITY":PRINT@63,STRING$(1,175)
70 PRINT@64,STRING$(32,175)
80 PRINT@98,"X=BACKGROUND Y=FOR
EGROUND"
90 PRINT@132,"<0-63>":PRINT@146,
"<0-63>"
100 FOR X=0 TO 63
110 FOR Y=0 TO 63
120 PRINT:PRINT"X =";:INPUT X
130 PRINT:PRINT"Y =";:INPUT Y
140 CLS:POKE&HFFBD,X:POKE&HFFBC,
Y
150 END
```

Phrase Centerer

By Gip Wayne Plaster, II

16K
ECB

One of the biggest pains for new programmers is trying to program aesthetic text screens. Centering text requires constant reference to the PRINT@ chart in the manual, and also a lot of trial and error. This short program eliminates frantic flipping of pages. Just run the program, type in your phrase and on what line of the screen you would like it to appear (there are 16 lines), and it gives you the proper PRINT@ location. This way you can design your text screen before you program it.

The listing: CENTERER

```
10 '*****
20 '**PHRASE CENTERER*****
30 '**A COCO QUICKY*****
40 '**BY GIP WAYNE PLASTER*****
50 '*****
60 CLS
70 LINE INPUT"STRING:";S$
```

```
80 L=LEN(S$)
90 IFL>32THENPRINT"TOO LONG":GOT
070
100 PRINT"THIS PHRASE HAS"L"CHAR
ACTERS."
110 PRINT"ON WHAT LINE DO YOU WI
SH TO PRINT?"
120 INPUT"ENTER 1-16:";R
130 IFR>16 OR R<1THEN120:' WILL
NOT ALLOW MORE THAN 16 OR LESS T
HAN 1
140 R=R-1:' CONVERT LINE TO COMP
UTER'S NUMBERING SYSTEM
150 LN=R*32:' CONVERTS FOR 32 CO
LUMN SCREEN
160 X=(32-L)/2:' FIND NUMBER OF
SPACES BEFORE PHRASE
170 CC=LN+X:' ADDS SPACES AND LI
NE
180 LC=INT(CC):' MAKES SURE NUMB
ER IS INTEGER
190 PRINT"THE PRINT @ LOCATION I
S";LC
200 PRINT"DO YOU WANT TO TRY AGA
IN?"
210 A$=INKEY$:IFA$=""THEN210
220 IFA$="Y"THEN70
```

Blockout Wipeout

By Tony Owens

Blockout is a short program full of fast and colorful action. The object is to keep the ever-growing blocks from reaching the center rail. To do this, use your right joystick to move your cannon up and down; press the firebutton and move left or right to fire. It is best to go for the longer blocks; if they reach your rail, they will deplete your energy.

The game has two levels and could be modified for more. The high-speed poke was left out but could be added. It's lightning fast with the high-speed poke on the CoCo 3!

The listing: BLOCKOUT

```

10 '-BLOCKOUT-'
20 'BY TONY OWENS'
30 'MONMOUTH, OREGON'
40 DIMA(16):DIMB(16):DIMC(16):DIMD(16):DIME(16):DIMY(16):V=8:LV=0:PLAY"T255L255"
50 CLS0:EG=EG+1:IF EG>2 THEN GOT
O360
60 FORY=1TO14:A(Y)=0:B(Y)=0:E(Y)=0:NEXTY
70 FORX=1TO14:C(X)=0:D(X)=0:E(X)=0:NEXTX
80 T=0:X=0:Y=0:EN=500:C=0:A=0
90 GOSUB160
100 A=0:FORT=1TO15:PRINT@31+A,CHR$(165);CHR$(170);:A=A+32:NEXTT
110 PRINT@1,STRING$(30,172);:POKE1024,174:POKE1024+31,173
120 PRINT@481,STRING$(30,32);:POKE1535,175:POKE1504,171
130 FORX=1040TO1488STEP32:POKEX,175:NEXTX
140 PRINT@481,"SCORE- 0";:PRINT@497,"ENERGY- 500";:POKE1520,175
150 GOTO 210
160 FORY=0TO14:A(Y)=1040+A:A=A+32:NEXTY:A=0
170 FORY=1TO15:Y(Y)=Y(Y)+A:A=A+4.5:NEXTY:A=0
180 C=140-(6*LV):FORX=1TO8:E(X)=C:E(X+8)=C:C=C+16:NEXTX
190 FORX=0TO14:C(X)=1040+A:A=A+32:NEXTX:A=0
200 RETURN
210 Y=RND(14):X=RND(14)
220 PRINT@A(Y)+B(Y)-1039,CHR$(E(Y));:B(Y)=B(Y)+LV+.5
230 IF B(Y)>14 THEN EN=EN-10:B(Y)=13:PLAY"01ABCDCBA"
240 PRINT@C(X)+D(X)-1010,CHR$(E(X));:D(X)=D(X)-LV-.5
250 IF D(X)<-13 THEN EN=EN-10:D(X)=-13:PLAY"01ABCDCBA":PRINT@504

```

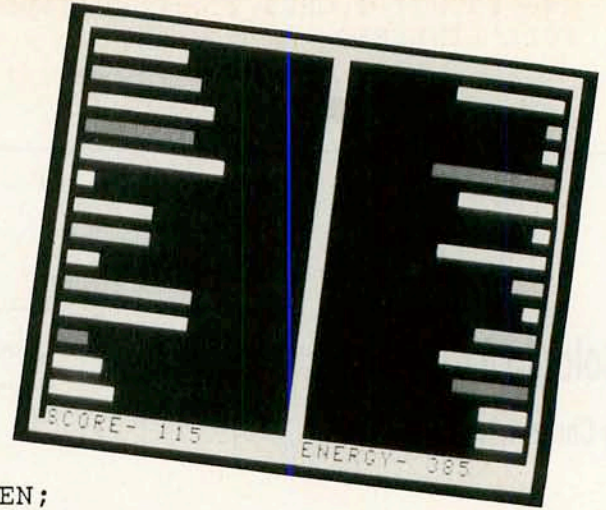

```

,EN;
260 IF EN<0 THEN LV=LV+.5:GOTO350
270 J=JOYSTK(0):IF PEEK(345)=254 THEN 320
280 J2=JOYSTK(1):IF J2<20 THEN V=V-1:IF V<1 THEN V=1
290 IF J2>40 THEN V=V+1:IF V>14 THEN V=14
300 POKEA(V),255:POKEA(V)-32,175:POKEA(V)+32,175
310 IF PEEK(345)=255 THEN 210
320 IF J<33 THEN FORS=A(V)+13 TO A(V)+B(V)+1 STEP-2:PRINT@S-1040,CHR$(125);CHR$(128);CHR$(128);:NEXT:PLAY"04ADG":B(V)=B(V)-2:PRINT@S-1038,CHR$(128);:IF B(V)<0 THEN B(V)=0
330 IFJ>33THENFORS=A(V)+17 TO A(V)+28+D(V)STEP2:PRINT@S-1040,CHR$(128);CHR$(128);CHR$(123);:NEXT:PLAY"02GDA":D(V)=D(V)+2:PRINT@S-1040,CHR$(128);:IFD(V)>0THEN D(V)=0
340 EN=EN-1:SC=SC+1:PRINT@487,SC;:PRINT@504,EN;:GOTO210
350 IFEG=2THEN360 ELSE FORX=1TO30STEP2:PLAY"V+ABC":NEXTX:CLS0:PRINT@106,"next";CHR$(128);"level";:FORX=1TO1000:NEXTX:GOTO50
360 CLS0:PRINT@105,"to";CHR$(128);"play";CHR$(128);"again";:PRINT@137,"press";CHR$(128);"any";CHR$(128);"key";
370 FORX=1TO5000:IF INKEY$=""THEN NEXTELSERUN

```

Submissions to "Novices Niche" are welcome from everyone. We like to run a variety of short programs that can be typed in at one sitting and are useful, educational and fun. Keep in mind, although the short programs are limited in scope, many novice programmers find it enjoyable and quite educational to improve the software written by others.

Program submissions must be on tape or disk. We're sorry, but we cannot key in program listings. All programs should be supported by some editorial commentary, explaining how the program works. If your submission is accepted for publication, the payment rate will be established and agreed upon prior to publication.

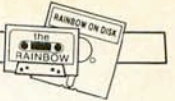

Make eye-catching newsletters with this two-column formatter

Printing In Two Columns

By Charles E. Brown, Jr.

Steve Lai's listing program (May 1985, Page 42) is designed to let you print a program listing in two columns on each page, saving paper and allowing easy comparison of screen to printout. The program works well and fills a need as is, but given minor modifications, it could well serve many other purposes.

Let's look at one example. With very few changes, the program could become valuable for the creation of newsletters by small businesses and clubs. Additionally, they could modify their customary correspondence format, offering polish and pizzazz.

I have redesigned Lai's program in order to give my correspondents letters unlike any they have received from other writers. Writing letters in such a new style is much like wearing a new and different suit, knowing that you'll attract attention on every street corner. You are doing something different and unique, expressing your individuality and personality.

Chuck Brown, who began computing in 1976, is a self-taught programmer interested in artificial intelligence for the Color Computer. He and his wife, Barbara, live in White Stone, Virginia, and own West Bay Company.

My modified program is called LETTERS. It provides enough header space at the top of Page 1 for you to design and insert your own logo or letterhead. Accompanying LETTERS is PERSLOGO, which prints a logo at the top of Page 1. Your examination of PERSLOGO will show how easily the desired text can be printed. A little study of the five data lines for block graphics may be needed to design your own graphics logo. Experiment and enjoy.

LETTERS will accept any ASCII file prepared by your word processor. But you must set your right margin so that you type no more than 36 characters per line (approximately half a page), and you must put a carriage return at the end of each line. Leave no blank lines at the top of the first page, and prepare your ASCII text without header space or embedded word processor printer codes of any kind other than the carriage returns. LETTERS will do all formatting and margin control for you.

There are variations among printers and word processing programs. For yours, some experimenting may be necessary. I use an Epson MX-80 printer with VIP Writer. In VIP Writer, I find that the first character is always lost. So I must insert one blank space at the very beginning of my text.

I have left printer codes out of my program, allowing you to insert your printer's codes at the beginning of LETTERS. If you want your columns to be right justified, you must refer to your printer and word processing manuals.

Up and Running

Use your own modification of the PERSLOGO program, changing the Epson printer codes to match your printer. When the program is run, it will end by showing an OD Error. Reposition

your first page to the top of the page (perforation).

Now load and run LETTER, which will help you input your ASCII text file and will give you the desired two-column output, with each page numbered in sequence. Merely follow the simple instructions on your screen.

Enjoy your letter writing. You will make an impact by giving your correspondence a neat and different appearance that will get your reader's attention. □

Editor's Note: The Personal Logo program is intended for use with an Epson MX-80 printer. Because the data used is that of the author, it will require alteration. The special control codes used are as follows:

```
CHR$(14)      turn on double width till
              next carriage return
CHR$(27)CHR$(69) turn on emphasized mode
CHR$(27)CHR$(70) turn off emphasized mode
CHR$(27)CHR$(71) turn on double-strike mode
CHR$(27)CHR$(72) turn off double-strike mode
```

In addition, the data lines 90 through 120 represent graphics characters which will need to be changed for your own logo. Subtract 32 from each value used since 32 is added by the program in Line 20. You may have to enter the graphics mode to achieve graphics characters on your printer.

✓	45111	42089
	12570	END61
	28024		

Listing 1: LETTER

```
5 'PROGRAM: LETTERS/TWO, GIVES
  TWO COLUMN PRINTING, WITH
  HEADER SPACE
10 CLEAR15000
11 CO=80 'PAGE WIDTH FOR TOTAL
  TEXT
12 NL=45 'LINES PER FIRST PAGE
  (LINE COUNTER)
13 TM=10 'WIDTH OF TOP MARGIN
  (VARY FOR LETTERHEAD)
14 SP=0 'SINGLE PAGE FLAG
  (CONTINUOUS/SINGLE PG)
15 LE=0 'LENGTH OF DATA ENTRY
16 'CN = COUNTER FOR CHARACTER
  S (RD$=INPUT CHARACTER READ)
17 'LF = LINEFEED
18 'PL$ = PRINT LINE STRING
19 'ST = FLAG FOR FINISH OF WO
```

```
RK
20 DIMPL$(116):AL=0:CN=1:Z$=CHR$(
  128):PG=0 '(PG=PAGE COUNTER)
21 BL$=STRING$(32,32) '1 LINE O
  F BLANKS ON SCREEN
22 IN=INT((CO/80)/2) 'DETERMINE
  S PAGE CENTERLINE
25 '-----MAIN MENU
30 CLS:PRINT" TWO COLUMN PROGR
  AM LISTER":PRINTSTRING$(32,131);
40 PRINTZ$"note"Z$" THE FILE TO
  BE USED MUST BE IN 'ASCII
  ' FORMAT."
45 PRINT:PRINTZ$"filename"Z$" ";
50 LINEINPUTDN$:IFLEFT$(RIGHT$(D
  N$,4),1)<>"/"THEN DN$=DN$+"/BAS"
60 IF LEN(DN$)>12 OR LEN(DN$)<5
  THEN30
65 PRINT:PRINTZ$"source"Z$"drive
  "Z$" ";:INPUTDD:DRIVEDD
70 PRINT:PRINTZ$"city"Z$"and"Z$"
  date"Z$" " 'INPUT, NEXT LINE, M
  AY BE UP TO 79 CHARACTERS, CENTE
  RED ON PAGE
80 LINEINPUT " ";NM$:LE=LEN(NM
  $):IFLE>CO THEN70
90 PRINT:PN=INT((CO-LE)/2)
100 PRINTZ$"stop"Z$"for"Z$"each"
  Z$"page"Z$" Y/N "
110 I$=INKEY$:IFLEFT$(I$,1)="Y"
  ORLEFT$(I$,1)="y" THENSP=1 ELSEI
  FLEFT$(I$,1)<>"N" ANDLEFT$(I$,1)
  <>"n" THEN110 ELSESP=0
119 '-----LOAD THE DATAFILE
  TO BE PRINTED
120 CLS:PRINT" LOAD THE FILE
  FROM DISK":PRINTSTRING$(32,131);
125 PRINT:PRINTZ$"insert"Z$"data
  "Z$"disk"Z$"in"Z$"drive"Z$;DD
128 PRINT:PRINT:PRINTZ$"press"Z$"
  "enter"Z$"to"Z$"continue"Z$;:INP
  UTAN$
130 OPEN"D",#1,DN$,1
140 FIELD#1,1 AS RD$
150 LF=LOF(1)
```

```

160 '-----SET UP NEW PAGE F
OR PRINTING
190 CLS:PRINT"      PREPARE FOR
NEW PAGE":PRINTSTRING$(32,131);:
PG=PG+1
200 PRINT:      PRINT" PLEASE WA
IT":PRINT:PRINT" PRINT LINES AR
E BEING COUNTED.":PRINT:PRINT" P
RINTING WILL START BEFORE THIS N
UMBER SHOWS"NL*2+1
205 PRINT@331,CHR$(129);STRING$(
5,131);CHR$(130):PRINT@363,CHR$(
133);:PRINT@369,CHR$(138):PRINT@
395,CHR$(132);STRING$(5,140);CHR
$(136)
210 FOR F=1 TO NL*2:PL$(F)=BL$:N
EXT F
220 FORF1=1TONL*2:PL$(F1)=STRING
$(37,32) '37 SHOWS COLUMN WIDTH
(INCLUDES CR)
230 FORF2=1TO37:CN=CN+1:IFCN>LF
THENST=1:GOTO300 '37 SHOWS COLU
MN WIDTH (INCLUDES CR)
240 GET#1,CN
250 IFRD$=CHR$(13) THEN280
260 MID$(PL$(F1),F2,1)=RD$
270 NEXTF2
280 PRINT@364,F1;:NEXTF1
300 IFSP=1 THENGOSUB400 ELSEIFAL
=0 THENGOSUB400 ELSEPRINT#-2:PRI
NT#-2
310 PRINT@480,      Z$"now"Z$"p
rinting"Z$:FORF=1 TONL:PRINT#-2,
TAB(IN);PL$(F); "      ";PL$(F+NL
)
320 NEXT
325 PRINT#-2:PRINT#-2,TAB(36)"Pa
ge"PG
330 IFST=1THENPRINT#-2,CHR$(12):
GOTO450
340 PRINT#-2,CHR$(12):NL=56:GOTO
190 '56 SHOWS NUMBER OF LINES,
PAGE 2 AND AFTER
390 '-----READY A NEW PAGE
FOR PRINTING
400 AL=1:CLS:PRINT"      INSERT
NEW PAGE":PRINTSTRING$(32,131);
:PRINTZ$"position"Z$"new"Z$"page
"Z$"in"Z$"printer"Z$
405 PRINT:PRINT:PRINTZ$"press"Z$
"enter"Z$"to"Z$"continue"Z$" ";:
LINEINPUTI$
410 PRINT#-2,STRING$(TM,13):PRIN
T#-2,TAB(PN);NM$:PRINT#-2:RETURN
420 '-----JOB IS FINISHED
450 CLOSE:CLS:PRINT"      PRINTI
NG IS FINISHED":PRINTSTRING$(32,
131);:PRINT" THE TWO COLUMN PRIN
TING IS      FINISHED."
455 PRINT:PRINT:PRINT" PRESS 'Y'
FOR ANOTHER PRINTING OR PRESS

```

The RAINBOW

THE COLOR COMPUTER MONTHLY MAGAZINE

Back Issue Availability

For greater convenience, order RAINBOW Back Issues through the Rainbow Magazine Services area of our Delphi CoCo SIG.

BACK ISSUES STILL AVAILABLE

Have you explored the wealth of information in our past issues? From our very first, four-page issue to many with more than 300 pages of material, it's all just for CoCo users — a great way to expand your library!

A WORLD OF INFO AT A BARGAIN PRICE

All back issues sell for the single issue cover price. In addition, there is a \$3.50 charge for the first issue, plus 50 cents for each additional issue for postage and handling if sent by United Parcel Service. There is a \$5 charge for the first issue, plus a \$1 charge for each additional issue on orders sent by U.S. Mail. UPS *will not* deliver to a post office box or to another country.

MOST ISSUES STILL AVAILABLE

Issues July 1981 through June 1982 are available on white paper in a reprint form. All others are in regular magazine form. VISA, MasterCard and American Express accepted. Kentucky residents please add 5 percent state sales tax. In order to hold down costs, we do not bill, and no C.O.D. orders are accepted.

Due to heavy demand, we suggest you order the back issues you want now while supplies last.

To check availability and order, review and fill out the form on the next page and mail it with your payment to:

THE RAINBOW
The Falsoft Building
P.O. Box 385
Prospect, KY 40059

BACK ISSUE ORDER FORM

(See overleaf for instructions.)

Please send me the following back issues:

MONTH/YEAR	PRICE	MONTH/YEAR	PRICE
VOLUME 1		VOLUME 5	
JUL '81 Premier Issue	\$2.00 <input type="checkbox"/>	AUG '85 Games	\$3.95 <input type="checkbox"/>
AUG '81	\$2.00 <input type="checkbox"/>	SEP '85 Education	\$3.95 <input type="checkbox"/>
SEP '81 Education	\$2.00 <input type="checkbox"/>	OCT '85 Graphics	\$3.95 <input type="checkbox"/>
OCT '81 Printer	\$2.00 <input type="checkbox"/>	NOV '85 Data Comm.	\$3.95 <input type="checkbox"/>
NOV '81	\$2.00 <input type="checkbox"/>	JAN '86 Beginners	\$3.95 <input type="checkbox"/>
DEC '81 Holiday	\$2.00 <input type="checkbox"/>	FEB '86 Utilities	\$3.95 <input type="checkbox"/>
JAN '82	\$2.00 <input type="checkbox"/>	MAR '86 Business	\$3.95 <input type="checkbox"/>
FEB '82	\$2.00 <input type="checkbox"/>	APR '86 Home Help	\$3.95 <input type="checkbox"/>
MAR '82	\$2.50 <input type="checkbox"/>	MAY '86 Printer	\$3.95 <input type="checkbox"/>
APR '82	\$2.50 <input type="checkbox"/>	JUN '86 Music	\$3.95 <input type="checkbox"/>
JUN '82	\$2.50 <input type="checkbox"/>	JUL '86 Anniversary	\$3.95 <input type="checkbox"/>
VOLUME 2		VOLUME 6	
JUN '83 Printers	\$2.95 <input type="checkbox"/>	AUG '86 Games	\$3.95 <input type="checkbox"/>
JUL '83 Anniversary	\$2.95 <input type="checkbox"/>	SEP '86 Education	\$3.95 <input type="checkbox"/>
VOLUME 3		VOLUME 7	
AUG '83 Games	\$2.95 <input type="checkbox"/>	SEP '87 Education	\$3.95 <input type="checkbox"/>
SEP '83 Education	\$2.95 <input type="checkbox"/>	OCT '87 Graphics	\$3.95 <input type="checkbox"/>
OCT '83 Graphics	\$3.95 <input type="checkbox"/>	NOV '87 Data Comm.	\$3.95 <input type="checkbox"/>
DEC '83 Holiday	\$3.95 <input type="checkbox"/>	DEC '87 Holiday	\$3.95 <input type="checkbox"/>
MAR '84 Business	\$3.95 <input type="checkbox"/>	JAN '88 Beginners	\$3.95 <input type="checkbox"/>
APR '84 Gaming	\$3.95 <input type="checkbox"/>	FEB '88 Utilities	\$3.95 <input type="checkbox"/>
MAY '84 Printer	\$3.95 <input type="checkbox"/>	MAR '88 Business	\$3.95 <input type="checkbox"/>
JUN '84 Music	\$3.95 <input type="checkbox"/>	APR '88 Home Help	\$3.95 <input type="checkbox"/>
JUL '84 Anniversary	\$3.95 <input type="checkbox"/>	MAY '88 Printer	\$3.95 <input type="checkbox"/>
VOLUME 4			
AUG '84 Games	\$3.95 <input type="checkbox"/>		
SEP '84 Education	\$3.95 <input type="checkbox"/>		
OCT '84 Graphics	\$3.95 <input type="checkbox"/>		
NOV '84 Data Comm.	\$3.95 <input type="checkbox"/>		
DEC '84 Holiday	\$3.95 <input type="checkbox"/>		
JAN '85 Beginners	\$3.95 <input type="checkbox"/>		
FEB '85 Utilities	\$3.95 <input type="checkbox"/>		
MAR '85 Business	\$3.95 <input type="checkbox"/>		
APR '85 Simulations	\$3.95 <input type="checkbox"/>		
MAY '85 Printer	\$3.95 <input type="checkbox"/>		
JUN '85 Music	\$3.95 <input type="checkbox"/>		
JUL '85 Anniversary	\$3.95 <input type="checkbox"/>		

RAINBOW INDEX A complete index to the first three years, July 1981 through June 1984, is printed in the July 1984 issue. Separate copies are available for \$2.50

The Fourth and Fifth Year Indexes including RAINBOW ON TAPE are in the July 1985 and July 1986 issues, respectively. The Sixth Year Index is in the July 1987 issue.

TOTAL _____
 KY RESIDENTS ADD 5% _____
 U.S. MAIL CHARGE _____
 SHIPPING & HANDLING _____
 U.P.S. CHARGE _____
TOTAL AMOUNT _____
ENCLOSED _____

Article Reprints

In instances where a given issue is now out of print and not available for purchase, we do provide photocopies of specific articles. The cost for this service is \$1.50 plus 50 cents S/H per article. This service is provided *only* in the case of out-of-stock issues.

Name _____

Address _____

City _____ State _____ ZIP _____

Payment Enclosed, or

Charge to my: VISA MC AE

CARD # _____

EXPIRATION DATE _____ PHONE () _____

SIGNATURE _____

TO ORDER BY PHONE (credit card orders only) call (800) 847-0309, 8 a.m. to 5 p.m. EST. All other inquiries call (502) 228-4492.

```
'N' TO STOP.":PG=Ø
46Ø I$=INKEY$:IFLEFT$(I$,1)="Y"
ORLEFT$(I$,1)="Y" THENRUN ELSEIF
LEFT$(I$,1)="N" ORLEFT$(I$,1)="n
" THENEND ELSE46Ø
55Ø 'FIRST SPACE ALWAYS LOST. SO
INDENT ONE SPACE TO START.
56Ø 'USE NO PRINT CODES IN TEXT.
CARRIAGE RETURN AFTER LINE.
57Ø 'DO NOT PLACE HEADER SPACES
IN FILE COPY. PROGRAM = 3,
OR 1Ø IF USING LETTERHEAD.
58Ø 'IF DATE IS TO BE PRINTED BY
PROGRAM, TOP CENTER, DO NOT
PLACE DATE IN DATA COPY.
59Ø 'USE VIP/WRITER LINELENGTH
OF 37, NON JUSTIFIED.
199Ø 'NOTE THAT YOU MUST COUNT
ANY 37-CHARACTER LINE AS
INCLUDING THE CARRIAGE
RETURN (36 CHARACTERS +CR)
2ØØØ 'LETTERS/TWO, 87Ø424. WAS
ORIGINALLY '2-COLUMN/BAS' IN THE
MAY 1985 RAINBOW, PAGE 44, BY
STEPHEN LAI. PROGRAM MODIFIED BY
C E BROWN FOR NEWSLETTERS AND
CORRESPONDENCE USE.
```

Listing 2: PERSLOGO

```
5 PRINT#-2:PRINT#-2:PRINT#-2
1Ø PRINT#-2,CHR$(27)CHR$(69)CHR$(
27)CHR$(71)
2Ø READA:IFA>1ØØ THENPRINT#-2,TA
B(8)CHR$(A+32);:GOTO2Ø
3Ø IFA>Ø THENPRINT#-2,STRING$(A,
B+32);:GOTO 2Ø
4Ø IFA=Ø THEN PRINT#-2:GOTO2Ø
5Ø ONABS(A) GOSUB6Ø,7Ø,8Ø:GOTO2Ø
6Ø PRINT#-2,TAB(28)CHR$(14)"CHAR
LES E. BROWN JR":RETURN
7Ø PRINT#-2,TAB(39) "ROUT
E 1, BOX 59Ø":RETURN
8Ø PRINT#-2,TAB(31) "WHIT
E STONE, VIRGINIA 22578-9765":RE
TURN
9Ø DATA 151,131,131,131,131,131,
131,131,131,131,131,171,Ø
95 DATA 149,128,17Ø,151,139,133,
17Ø,151,171,149,128,17Ø,-1
1ØØ DATA 149,128,17Ø,149,16Ø,144
,17Ø,151,171,148,128,17Ø,-2
11Ø DATA 149,128,138,141,142,133
,138, 141,142,133,128,17Ø,-3
12Ø DATA 141,14Ø,14Ø,14Ø,14Ø,14Ø
,14Ø,14Ø,14Ø,14Ø,14Ø,142,Ø
1ØØØ PRINT#-2,CHR$(27)CHR$(7Ø)CH
R$(27)CHR$(72)
2ØØØ 'PERSLOGO/BAS, 87Ø429. WILL
PRINT PERSONAL LETTERHEAD
AND GRAPHICS
```

Only NRI teaches you to service all computers as you build your own fully IBM-compatible microcomputer

NEW!
Training now includes 20 meg hard disk drive!

With more and more new applications being developed for every facet of business, education, and personal computer use, the demand for trained computer service technicians surges forward. The Department of Labor ranks computer service high on its list of top growth fields, with accelerated demand creating more than 30,000 new jobs within the next 10 years.

Total systems training

No computer stands alone . . . it's part of a total system. And if you want to learn to service and repair computers, you have to understand computer systems. Only NRI includes a powerful computer system as part of your training, centered around the new, fully IBM-compatible Sanyo 880 Series computer.

You'll assemble the Sanyo's "intelligent" keyboard, install the power supply and 5 1/4" floppy disk drive, and interface the high-resolution monitor. Plus now you also install a powerful 20 megabyte hard disk drive—today's most-wanted peripheral—to dramatically increase your computer's data storage capacity while at the same time giving you lightning-quick data access. You get more confidence-building, real-world experience as you go on to master programming, circuit design, and peripheral maintenance.

No experience necessary—NRI builds it in

Even if you've never had any previous training in electronics, you can succeed with NRI training. You'll start with the basics, then rapidly build on them to master such concepts as digital logic, microprocessor design, and computer memory. You'll build and test advanced electronic circuits using the exclusive NRI Discovery Lab®, professional digital multimeter, and logic probe. Like your computer, they're all yours to keep as



Your NRI total systems training includes all this: NRI Discovery Lab to design and modify circuits • Four-function digital multimeter with walk-you-through instruction on audio tape • Digital logic probe for visual examination of computer circuits • Sanyo 880 Series computer with "intelligent" keyboard and 360K, 5 1/4" floppy disk drive • 20 megabyte hard disk drive you install internally • High-resolution monochrome monitor • 8K ROM, 256K RAM • Bundled software including GW-BASIC, MS-DOS, WordStar, CalcStar • Reference manuals, schematics, and bite-sized lessons.

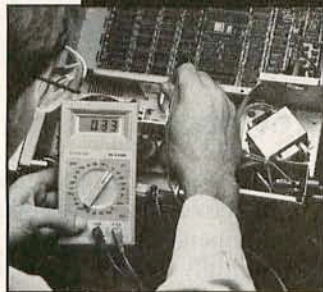

NRI is the only technical school that trains you on a total computer system. You'll install and check keyboard, power supply, disk drive, and monitor, following step-by-step directions.

part of your training. You even get some of the most popular software, including WordStar, CalcStar, GW Basic and MS DOS.

Send for 100-page free catalog

Send the coupon today for NRI's 100-page, full-color catalog, with all the facts about at-home computer training. Read detailed descriptions of each lesson, each experiment you perform. See each piece of hands-on equipment you'll work with and keep. And check out NRI training in other high-tech fields such as Robotics, Data Communications, TV/Audio/Video Servicing, and more.

SEND COUPON TODAY FOR FREE NRI CATALOG!

NRI SCHOOLS

McGraw-Hill Continuing Education Center
3939 Wisconsin Avenue, NW, Washington, DC 20016



- CHECK ONE FREE CATALOG ONLY
- | | | |
|-------------------------------------------------------|-------------------------------------------------------|--------------------------------------------------------------------|
| <input type="checkbox"/> Computer Electronics | <input type="checkbox"/> Electronic Design Technology | <input type="checkbox"/> Air Conditioning, Heating & Refrigeration |
| <input type="checkbox"/> TV/Video/Audio Servicing | <input type="checkbox"/> Industrial Electronics | <input type="checkbox"/> Small Engine Repair |
| <input type="checkbox"/> Robotics | <input type="checkbox"/> Communications Electronics | <input type="checkbox"/> Electrician |
| <input type="checkbox"/> Electronic Music Technology | <input type="checkbox"/> Basic Electronics | <input type="checkbox"/> Locksmithing & Electronic Security |
| <input type="checkbox"/> Satellite Electronics | <input type="checkbox"/> Bookkeeping and Accounting | <input type="checkbox"/> Travel Careers |
| <input type="checkbox"/> Digital Electronic Servicing | <input type="checkbox"/> Building Construction | <input type="checkbox"/> Telephone Servicing |
| | <input type="checkbox"/> Automotive Servicing | <input type="checkbox"/> Paralegal |

For Career courses approved under GI Bill
 check for details.

Name (Please print) _____ Age _____
Street _____
City/State/Zip _____ We'll give you tomorrow. Accredited by the National Home Study Council 205-058

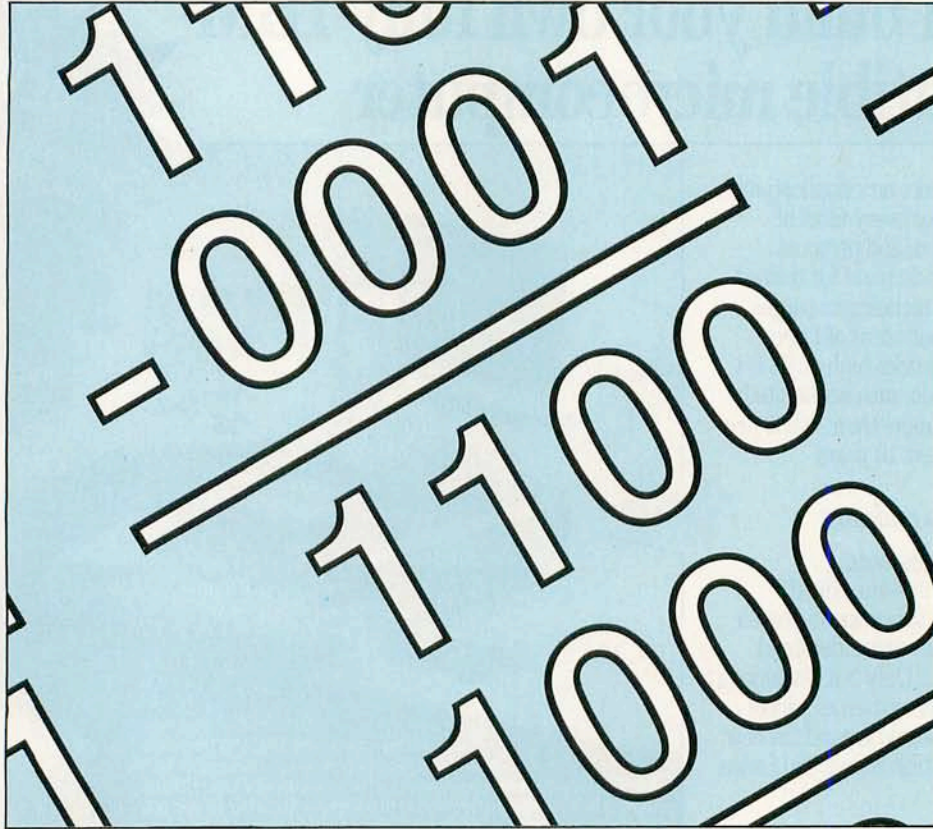

The Ins and Outs of Boolean

By Eric Levinson

This program was designed to test students in Boolean addition, multiplication and subtraction. There are 20 questions and you must answer the question correctly by pressing either a 0 or 1. The 0 stands for a binary "off" state while the 1 stands for a binary "on" state. The right arrow allows you to make corrections by completely erasing your answer.

When the program is run, the computer asks for your name. This allows a whole classroom to use and store each student's results on disk or cassette. Student records may then be called up by typing PRINT SCORES at the first prompt.

The first five problems ask you to add

two 4-digit binary numbers, and the next five ask you to subtract two 4-digit numbers. The following five ask you to multiply two 4-bit numbers, and the last five problems ask you to add two 8-bit numbers. Notice that the last five problems are timed, but the results of the timing are not recorded on disk.

Cassette operation may be used by changing the following lines:

```
1560 OPEN"0",#-1,LEFT$(N$,8)
1570 PRINT#-1,R,R1,R2,R3,W,
W1,W2,W3,N$
1580 CLOSE #-1
1670 OPEN"I",#-1,N$
1680 INPUT#-1,R,R1,R2,R3,W,
W1,W2,W3,N$
1690 CLOSE #-1
```

Eric Levinson is studying to be an electronics engineer. Previously, he was a service technician for Apple, IBM, Zenith and Compaq.

(Questions or comments may be addressed to the author at 151 Hearstone, Irvine, CA 92714. Please enclose an SASE when requesting a reply.) □

✓	240186	12207
	500115	1470251
	75036	160083
	970170	END172

The listing: BOOLEAN

```

10 ' PROGRAM DEVELOPED AND W
RITTEN BY
20 ' ERIC LEVINSON
30 ' 1039 NEVADA STREET
40 ' GLENWOOD, IL 60425
50 ' (312) 799-6747
60 ' COPYRIGHT (C) 1987
70 CLEAR 5000
80 DIM B$(255)
90 CLS
100 PRINT"BINARY ARITHMETIC"
110 PRINT"BY ERIC LEVINSON"
120 PRINT"WHAT IS YOUR NAME";
130 INPUT N$
140 IF N$="PRINT SCORES" THEN 16
30
150 PRINT"STANDBY"
160 AA=0
170 FOR A=0 TO 1
180 FOR B=0 TO 1
190 FOR C=0 TO 1
200 FOR D=0 TO 1
210 IF A=1 THEN A$="1"ELSE A$=""
"
220 IF B=1 THEN B$="1"ELSE B$=""
"
230 IF C=1 THEN C$="1"ELSE C$=""
"
240 IF D=1 THEN D$="1"ELSE D$=""
"
250 B$(AA)=A$+B$+C$+D$
260 AA=AA+1
270 NEXT D,C,B,A
280 FOR A=1 TO 5
290 CLS
300 A1=RND(16)-1:A2=RND(16)-1
310 IF A1+A2>15 THEN 300
320 PRINT@0,"PROBLEM #"A
330 PRINT@172,B$(A1)
340 PRINT@203,"+"B$(A2)
350 PRINT@235,"-----"
360 B$=""
370 GOSUB 1160
380 ANS$=B$(A1+A2)
390 FOR B=0 TO 15
400 IF B$=B$(B) THEN 410 ELSE NE
XT B
410 IF B=A1+A2 THEN PRINT@267,"R

```

Hardware Special Communications Package

300/1200 baud Fully Hayes
compatible

Modem - 1 Year Warranty

\$109.00

[Modem & Cable]

300/1200/2400 baud
Fully Hayes

Compatible Modem - CCITT
1 Year Warranty

\$179.00

[Modem & Cable]

Software

'KEEP-TRAK' General Ledger Reg. \$69.95—Only \$39.95

"Double-Entry" General Ledger Accounting System for home or business: 16k, 32k, 64k. User-friendly, menu-driven. Program features: balance sheet, income & expense statement [current & 'YTD'], journal, ledger, 899 accounts [2350 entries on 32k & 64k [710 accounts & entries on 16k] [disk only]. Version 1.2 has screen printouts. Rainbow Review 1.1 - 9/84 : 1.2-4/85

"OMEGA FILE" Reg. \$69.95—ONLY \$24.95

Filing data base. File any information with Omega File. Records can have up to 16 fields with 255 characters per field [4080 characters/record]. Sort, match & print any field. User friendly menu driven. Manual included [32k/64k disk only].

Rainbow Review 3/85. Hot CoCo 10/85

BOB'S MAGIC GRAPHIC MACHINE

Can generate BASIC code to use in your programs. Easy drawing and manipulation of circles, ellipses, boxes, lines and ARCS. Single joystick operation with on line HELPS at all times. Allows text on the graphics screen & movement of objects on the screen. Can be used as a stand-alone graphics editor. Instruction Manual. **GRAPHICS EDITOR. REG. \$39.95—ONLY \$24.95** for disk or tape. 64k ECB.

Rainbow Review 7/85. Hot CoCo 9/85 **"The graphics bargain of the year"**

'KEEP-TRAK' Accounts Receivable.

Features: auto interest calculation, auto ageing of accounts, installment sales, total due sales, explanation space as long as you need, detailed statements, 'KEEP-TRAK' General Ledger tie in, account number checking, credit limit checking & more. User friendly/menu driven. Includes manual. **\$39.95** or **\$49.95** General Ledger & Accounts Receivables. [Disk Only].

'COCO WINDOWS'

With hi-res character display and window generator. Features an enhanced key board [clicks] and 10 programmable function keys. Allows the user to create multiple windows from basic. Includes menu driven printer setup and auto line numbering. Four function calculator, with memory. The above options can be called anytime while running or writing in BASIC. APPLE PULL YOUR DRAPES. YOU DON'T WANT TO SEE THIS. **\$24.95** [disk or tape] includes manual.



THE OTHER GUYS CoCo

55 North Main Street
Suite 301-D
PO Box H
Logan Utah 84321



(801) 753-7620
(800) 942-9402

[Add \$3.00 for postage & handling]

C.O.D., Money Order, Check in U.S. Funds [Please specify if J&M controller]

**NEW FREE
CATALOG**

```

IGHT":R=R+1
420 IF B<>A1+A2 THEN PRINT@267,"
WRONG":W=W+1
430 FOR AA=0 TO 1000:NEXT AA
440 NEXT A
450 FOR A=6 TO 10
460 CLS
470 A1=RND(16)-1:A2=RND(16)-1
480 IF A1-A2<0 THEN 470
490 PRINT@0,"PROBLEM #"A
500 PRINT@172,B$(A1)
510 PRINT@203,"-"B$(A2)
520 PRINT@235,"-----"
530 B$=""
540 GOSUB 1160
550 ANS$=B$(A1-A2)
560 FOR B=0 TO 15
570 IF B$=B$(B) THEN 580 ELSE NE
XT B
580 IF B=A1-A2 THEN PRINT@267,"R
IGHT":R1=R1+1
590 IF B<>A1-A2 THEN PRINT@267,"
WRONG":W1=W1+1
600 FOR AA=0 TO 1000:NEXT AA
610 NEXT A
620 FOR A=11 TO 15
630 CLS
640 A1=RND(16)-1:A2=RND(16)-1
650 IF A1*A2>15 THEN 640
660 IF A1=0 OR A2=0 THEN 640
670 PRINT@0,"PROBLEM #"A
680 PRINT@172,B$(A1)
690 PRINT@203,"*"B$(A2)
700 PRINT@235,"-----"
710 B$=""
720 GOSUB 1160
730 ANS$=B$(A1*A2)
740 FOR B=0 TO 15
750 IF B$=B$(B) THEN 760 ELSE NE
XT B
760 IF B=A1*A2 THEN PRINT@267,"R
IGHT":R2=R2+1
770 IF B<>A1*A2 THEN PRINT@267,"
WRONG":W2=W2+1
780 FOR AA=0 TO 1000:NEXT AA
790 NEXT A
800 PRINT:PRINT"THE NEXT TEST WI
LL BE TIMED."
810 PRINT"STANDBY FOR 8 BIT NUMB
ERS."
820 AA=16
830 FOR E=1 TO 15
840 FOR A=0 TO 1
850 FOR B=0 TO 1
860 FOR C=0 TO 1
870 FOR D=0 TO 1
880 IF A=1 THEN A$="1" ELSE A$="
0"
890 IF B=1 THEN B$="1" ELSE B$="
0"
900 IF C=1 THEN C$="1" ELSE C$="
0"
910 IF D=1 THEN D$="1" ELSE D$="
0"
920 B$(AA)=B$(E)+A$+B$+C$+D$
930 AA=AA+1
940 NEXT D,C,B,A,E
950 FOR A=0 TO 15:B$(A)=""0000"+B
$(A):NEXT A
960 FOR A=16 TO 20
970 CLS:TT=0
980 A1=RND(256)-1:A2=RND(256)-1
990 IF A1+A2>255 THEN 980
1000 PRINT@0,"PROBLEM #"A
1010 PRINT@170,B$(A1)
1020 PRINT@201,"+"B$(A2)
1030 PRINT@233,"-----"
1040 B$=""
1050 TIMER=0
1060 GOSUB 1280
1070 ANS$=B$(A1+A2)
1080 FOR B=0 TO 255
1090 IF B$=B$(B) THEN 1100 ELSE
NEXT B
1100 IF B=A1+A2 THEN PRINT@265,"
RIGHT":R3=R3+1
1110 IF B<>A1+A2 THEN PRINT@265,"
WRONG":W3=W3+1
1120 PRINT"TIME:"TT"SECONDS."
1130 FOR AA=0 TO 1000:NEXT AA
1140 NEXT A
1150 GOTO 1410
1160 FOR AT=271 TO 268 STEP -1
1170 A$=INKEY$
1180 IF A$=CHR$(9) THEN 1710
1190 PRINT@AT,CHR$(128);
1200 FOR T=0 TO 10:NEXT T
1210 PRINT@AT,CHR$(207);
1220 FOR T=0 TO 10:NEXT T
1230 IF A$=""0" OR A$=""1" THEN 12
40 ELSE 1170
1240 B$=A$+B$
1250 PRINT@AT,A$;
1260 NEXT AT
1270 RETURN
1280 FOR AT=273 TO 266 STEP -1
1290 A$=INKEY$
1300 IF TIMER>59 THEN TIMER=0:TT
=TT+1
1310 IF A$=CHR$(9) THEN GOTO 176
0
1320 PRINT@AT,CHR$(128);
1330 FOR T=0 TO 10:NEXT T
1340 PRINT@AT,CHR$(207);
1350 FOR T=0 TO 10:NEXT T
1360 IF A$=""0" OR A$=""1"THEN 137
0 ELSE 1290
1370 B$=A$+B$
1380 PRINT@AT,A$;
1390 NEXT AT

```



```

1400 RETURN
1410 CLS
1420 IF RR=1 THEN PRINT N$
1430 PRINT"EVALUATION"
1440 PRINT"    PROBLEM        NUMBER
NUMBER"
1450 PRINT"    NUMBER        WRONG
RIGHT"
1460 PRINT"-----
-----"
1470 PRINT "  1 THRU 5      "W"
"R
1480 PRINT "  6 THRU 10     "W1"
"R1
1490 PRINT "11 THRU 15     "W2"
"R2
1500 PRINT "16 THRU 20     "W3"
"R3
1510 PRINT:PRINT"YOU GOT"W+W1+W2
+W3"WRONG"
1520 PRINT"OUT OF 20 QUESTIONS F
OR A"
1530 P=((R+R1+R2+R3)/20)*100
1540 PRINT"PERCENTAGE OF"P"%."
1550 IF RR=1 THEN 1610
1560 OPEN"O", #1, LEFT$(N$, 8)
1570 WRITE#1, R, R1, R2, R3, W, W1, W2,

```

```

W3, N$
1580 CLOSE #1
1590 PRINT"THANK YOU "N$
1600 PRINT"PRESS ANY KEY TO BEGI
N NEW TEST"
1610 IF INKEY$="" THEN 1610 ELSE
1620
1620 IF RR=0 THEN 10
1630 CLS:RR=1
1640 PRINT"NAME OR <E>XIT"
1650 INPUT N$
1660 IF N$="E" THEN 10
1670 OPEN"I", #1, N$
1680 INPUT #1, R, R1, R2, R3, W, W1, W2
,W3, N$
1690 CLOSE #1
1700 GOTO 1410
1710 FOR TA=268 TO 271
1720 PRINT @TA, " ";
1730 NEXT TA
1740 B$=""
1750 GOTO 1160
1760 FOR TA=266 TO 273
1770 PRINT@TA, " ";
1780 NEXT TA
1790 B$=""
1800 GOTO 1280

```



CoCo Cat
Says
Drugs Are
NOT
User-Friendly



The LLISTing Formatter

By Clay Howe

Most LLIST formatting utilities require that the BASIC program to be LLISTed first be saved as an ASCII file, then read from disk or cassette and output to a printer in the required line lengths. *BestList* uses a machine language routine to handle the LLISTing and is controlled by the user through a BASIC program.

BestList's machine language code is contained in DATA lines, which are read in by the program. The user is therefore able to modify the code.

When you run the program, it will determine if the system is disk or cassette and configure itself for the system in use. You are then presented with the main menu and its three options:

- 1) Set Printer Baud
- 2) Change Defaults
- 3) LLIST Program

Pressing 1 brings up another menu, which permits you to set the printer baud rate to 600, 1200, 2400, 4800 or 9600. The default printer baud rate is

Clay Howe is a self-taught electronic and computer hobbyist. He has developed several hardware modifications for both the CoCo and radio control systems. When he can get away from his CoCo, and weather permits, he enjoys flying RC sailplanes.

9600, so this option may be bypassed if you want to use that rate. After a selection is made, the program returns to the main menu.

Pressing 2 displays the default menu, which shows the current values for the following: column width, indentation, printout length and the lines to skip.

Column width is the number of characters per line that you want your LLISTing to have. It may be changed to any value from 1 to 255. The default value is 80.

Indentation comes into play if a program line is longer than the width you have selected. The second row of the program line will be LLISTed below the first portion of the line, but it will be indented from the left margin the number of spaces you have selected. This value must be greater than or equal to 1. The default is 4, which LLISTs only line numbers at the left margin.

Printout length is the number of lines to be printed before a "skip over perforation" is performed. The program is set up to a page length of 66 lines, because most printers print six lines per inch. The printout length may be anything from 1 to 65. The default is 60.

The "Skip Lines" option sets the number of blank lines that will be printed as the program skips over the perforation. It will always equal 66 minus the printout length value. The default is 6.

A note about printout length and

skipping lines: Entering a value into either of these options automatically reconfigures the other so that the sum of the two always equals 66. If one is changed, the other will take care of itself. *BestList* will not accept a value of zero for any of the four default options.

Pressing 3 at the main menu displays another screen, which will ask for input concerning the program you want to LLIST. If you are using a cassette system, you need only enter the filename and then press ENTER when the tape with the program to be LLISTed is in place and the cassette Play button is pressed. Pressing ENTER at the filename prompt will load the next file on the cassette.

If a disk system is in use, you must enter a filename and extension at the first prompt (enter the extension only if it is other than .BAS); otherwise, only the filename is required. Then the number of the drive containing the program to be LLISTed is prompted. Pressing ENTER at that prompt will access Drive 0.

An added feature when using disk is the ability to press ENTER at the filename/extension prompt, followed by the drive number entry at that prompt, and have a disk drive directory pop onscreen. Pressing ENTER after the directory is displayed returns you to the filename/extension prompt.

The program will execute the machine language routine when Option 3 (LLIST Program) is selected from the

Special: Calligrapher font set #7 - Five new small fonts (this is "Roman"). \$18.50 - Specify tape/disk; OS9/RSDOS. Deduct \$5 on ANY additional program thru May 31, 1988.

CALLIGRAPHER

CoCo Calligrapher - (Hybrid BASIC/ML) Turn your CoCo and dot-matrix printer into a calligrapher's quill. Make beautiful invitations, flyers, certificates, labels and more. Includes 3 fonts: *Gay Nineties*, *Old English* and *Cartoon*. The letters are 1/2 inch high and variably spaced. Works with many printers including Epson, Gemini, Radio Shack, Okidata 92A, Banana and Prowriter. Additional fonts are available (see below). Tape/Disk; \$24.95.

OS9 Calligrapher - (C) Although a different program from the CoCo Calligrapher, the OS9 Calligrapher prints all the same fonts. It reads a standard text file which contains text and formatting directives. You may specify the font to use, change fonts at any time, centering, left, right or full justification, line fill, margin, line width, page size, page break and indentation. Similar to *troff* on UNIX™ systems. Includes Gay Nineties, Old English and Cartoon fonts. Additional fonts are available (see below). Disk only; OS9 Level I or II; \$24.95.

Calligrapher Fonts - Requires Calligrapher above. Each set on tape or disk; specify RSDOS or OS9 version; \$14.95 each. Set #1 - (9 fonts) Reduced, reversed and reduced-reversed versions of Gay Nineties, Old English and Cartoon; Set #2 - (8 fonts) Old Style and Broadway; Set #3 - (8 fonts) Antique and Business; Set #4 - (8 fonts) Wild West and Checkers; Set #5 - (10 fonts) Stars, Hebrew and Victorian; Set #6 - (8 fonts) Block and Computer;

Economy Font Packages on disk; specify RSDOS or OS9; 20.95; **Font Package #1** - Above font sets 1, 2 and 3 (25 fonts) on one disk. **Font Package #2** - Above font sets 4, 5 and 6 (26 fonts) on one disk. Both Packages #1 and #2 (51 fonts) on one disk; 40.95.

Calligrapher Combo Package - *Everything!*; specify RSDOS or OS9; Includes the Calligrapher and both Font Packages on two disks; \$69.95.

UTILITIES

Piratorator - (100%ML) Utility to allow your own disk-based BASIC or ML programs to display a graphics title screen and then self-start after loading. Adds copy protection to your programs but still allows users to create non-executable backups! Includes Semigraf. Disk only; CoCo 1, 2, 3 (except Semigraf); \$30.95.

Super Screen Machine - (100% ML) Put your CoCo into high resolution mode for your own BASIC or ML programs. Smooth scroll, key click, lower case with colored characters. Tape/Disk; 32K CB; CoCo 1, 2, 3 (except 64K mode); \$19.95.

Color Disk Manager - (100%ML) Disk utility with these features: Disk repair, selective track initialization, verify sectors, backups, tape to disk transfer, ROM Pak execution from disk, much more! Tape/Disk; CoCo 1, 2, 3 (except for 64K mode); \$24.95.

Color Tape Manager - (100% ML) Tape utility with these features: display start, end and exec address of ML programs, convert ML programs into DATA statements, append ML to BASIC, much more! Tape/Disk; 16K ECB; CoCo 1, 2, 3 (except for 64K mode); \$19.95.

OS9 Patcher - (C) Display and modify the contents of a file or memory module. Hexidecimal, decimal and ASCII modes. Search feature. Calculates module CRCs; Generates patch command files. Disk only; OS9 Level I or II; \$19.95.

INFORMATION MGT.

TIMS (The Information Management System) - (Hybrid BASIC/ML) Tape or disk, fast and simple general data base program. Create files of records that can be quickly sorted, searched, deleted and updated. Powerful printer formatting. Up to 8 user fields, sort on up to 3 fields. Tape/Disk; \$19.95 (see combo pkg below).

TIMS Mail - (Hybrid BASIC/ML) Tape or Disk based mailing list management program. Files are compatible with TIMS. Fast and simple to use. Supports labels 1, 2 or 3 across, 2 1/2 to 4 inches wide. Tape/Disk; \$19.95 (see combo pkg below).

TIMS Utility - (Hybrid BASIC/ML) Utility companion for TIMS and TIMS Mail to allow multi-term search (AND and OR logic), global change and delete, split large files and more! Tape/Disk; \$14.95 (see combo pkg below).

TIMS Combo Package - All three of the above programs: TIMS, TIMS Mail and TIMS Utility on one disk - \$34.95.

SPORTS STATISTICS

Statistics programs for the coach, team manager or avid fan who wants to keep accurate team and opponent records. Printer output supported. The following are available: Baseball, Basketball, Football and Soccer. Disk only; \$19.95 each.

EDUCATIONAL

Trig Attack - (100%ML) Ages 9 and up. In this educational arcade game, enemy *trigs* travel along math curves. Players learn important mathematical concepts as they play. Sound effects, colorful graphics. Excellent manual includes an introduction to trigonometry. Tape 16K CB/Disk 32K ECB; CoCo 1, 2, 3; \$19.95.

Silly Syntax - (Hybrid BASIC/ML) Ages 5 and up. Story creation game; output to screen or printer; includes 2 stories or create your own. Tape/Disk; \$19.95 or disk with 62 stories for \$20.95. Sets of 10 stories on tape/disk for \$4.95; Fairy Tales, Current Events, X-Rated, Sing-Along, Adventure, Potpourri.

Bible Stories Adventure - (Hybrid BASIC/ML) Ages 4 & up. A graphics adventure game for young children & their families. Old testament. Tape/Disk; \$19.95.

The Presidents of the USA - (100%ML) Ages 10 and up. Two trivia games, user modifiable, printer output supported. Tape/Disk; 16K ECB; \$19.95.

The Great USA - Ages 9 and up. Trivia game of the 50 states. Capitals, nicknames, abbreviations, flowers, trees and birds. Tape/Disk; 16K ECB; \$19.95.

Galactic Hangman - Ages 7 and up. Exciting new twist to the popular word game. Outstanding graphics; 700 word vocabulary. Tape/Disk; 16K ECB; \$19.95.

PreReader - (Hybrid BASIC/ML) Ages 3-5 (level 1); Ages 5-7 (level 2); Great graphics and music. Level 1: match colors, shapes, letters and numbers; Level 2: match letters and consonant blends with their sounds. Tape/Disk; Joystick; \$19.95.

Statgraf - High school and college level; Linear regression analysis program combined with a plotting and line graphing system. Up to 250 x/y pairs; data transformation; residuals; regression line; print graph with screen print program (not supplied); Tape/Disk; \$19.95.

SPECIAL INTEREST

Rental Property Income and Expense Management Package - Maintain your rental property income and expense records. Print output supported. 28 expense categories. *This program may be tax deductible.* Disk only; \$29.95.

Radio Systems Design Calculations - Performs 14 different calculations commonly used in design or evaluation of land mobile radio systems, satellite TV, etc. Tape/Disk; \$19.95.

CoCo Knitter - Easy to use program to display or print instructions to knit a sweater: Cardigan or Pullover; Round or V-neck; Raglan or Set-in Sleeve; 3 weights or yarn; 8 sizes from baby to man. Tape/Disk; \$19.95.

Flying Tigers - (100% ML) Fast *Defenders* style arcade game. 5 levels of difficulty; Outstanding graphics and sound effects. Tape/Disk; Joystick; \$19.95.



SUGAR SOFTWARE
P.O. Box 7446
Hollywood, Florida 33081
(305) 981-1241

All programs run on the CoCo 1, 2 and 3, 32K Extended Basic, unless otherwise noted. Add \$1.50 per tape or disk for shipping and handling. Florida residents add 6% sales tax. COD orders add \$5. Dealer inquiries invited. Orders generally shipped in 24-48 hours. No refunds or exchanges without prior authorization.

main menu. After the program to be LLISTed is loaded, the normal screen OK prompt will let you know that you may proceed with the normal LLISTing process. When the printer is online and the paper is properly set (a perforation a little above the print head will do), simply type LLIST and press ENTER, and your hard copy will be made using the column width, indentation, printout length and line skip values that were last in effect at the Change Defaults menu.

“The column width, indentation, printout length and line skip defaults may also be easily modified with just a few changes to the program.”

You can use *BestList* without going to any of the configuration menus if all of the defaults match your requirements. Selecting the LLIST option at the main menu causes the program to jump to the READ DATA and initialization routine before it displays the LLIST Program menu. If you select the Change Defaults option, it will also jump to the initialization routine before the default menu appears.

After an LLIST has been made, you can do another with the same defaults by entering EXEC before entering LLIST — this resets the line counter in the machine language routine to zero. If you want to do another LLIST but with different defaults, just load and run the program again. If your CoCo has not been powered down, chances are the machine language routine will still be intact; and an initialization will not be performed at any prompt. You can make any desired default changes and proceed with the next LLISTing.

If, by rare chance, the screen blanks or the CoCo hangs up when trying to do a second LLIST, just turn the machine off for a few seconds, then start over again.

Machine language programs that are normally loaded with the command LOADM or CLOADM cannot be LLISTed using this program.

Whatever drive number you select

when loading a program from the LLIST Program menu will become the default drive number until it is changed at that menu, or by entering DRIVE n (n =drive number desired) after an LLISTing is complete.

Customizing the Program

There are several things you can do to the program that will make it easier for you to use if you find that most of your LLISTing is done using the same configuration.

The first change you may want to make is the default printer baud rate. Some popular printers will work only at 600 or 1200 baud. Line 100 sets the baud rate with a poke to memory address 150; in this case a 1 is poked. The poke value is set up as the variable BD. To use another baud rate, just change the 1 in BD=1 to the value for the rate you want to use: 600 baud, BD=B7; 1200 baud, BD=41; 2400 baud, BD=1B; 4800 baud, BD=7.

The column width, indentation, printout length and line skip defaults may also be easily modified with just a few changes to the program. Any value that you want to change must first be converted from decimal to hexadecimal. For example, if you want the default column width to be 64, you would first convert 64 to Hex by entering on your CoCo the command ?HEX\$(64). The screen would display the number 40, which is the Hex equivalent of decimal 64. The 40 would then be edited into the proper DATA position.

The value for column width is the 50 (Hex, remember?) at DATA position 4 in Line 530. The value for indentation is the 04 at DATA position 15 in Line 530. The printout length value is the 3C at DATA position 13 in Line 540. The line skip value is the 06 at DATA position 17 in Line 540.

Lines 530 and 540 each contain 18 DATA “positions,” from 1 to 18. Reconfigure the *BestList* defaults by inserting the new Hex value at the appropriate DATA line position. Do not use zero when changing any of the default values in the DATA lines.

Program lines 530 and 540 are listed below with the DATA positions indicated:

```
530 DATA 96,9C,81,50,25,13,
86,0D,BD,A2,BF,B6,20,C6,04,
BD,A2,BF
540 DATA 5A,26,FA,6C,8D,FF,
CE,AG,8D,FF,CA,81,3C,25,CF,
C6,06,86
```

Don't forget to save the customized version before you proceed with LLISTing. If you don't save it, you'll lose it!

Lines	Description
100-150	set up both numeric and string variables for later use. Line 120 determines if the system is cassette- or disk-based.
500-550	contain the data that is read in by the READ DATA routine and poked into memory. It will then be the machine language LLIST routine.
1000-1090	used for the main menu.
1500-1640	used for the printer baud menu. Line 1610 contains a short string that is converted by a MID\$ function to select a baud rate. Be sure that a character (0 is used) precedes the B7 in the string.
2000-2120	the READ DATA routine. This is where the DATA in lines 500 and 550 are converted to the machine language LLIST routine.
2500-2660	take care of the default menu and any changes you make while using this option. Lines 2620 through 2650 do the actual pokes when changes are made. Note that lines 2640 and 2650 poke two locations to match the printout length to the line skips.
3000-3150	contain the LLIST menu and the routine to get the program you want to LLIST, do a directory and select a drive number if a disk system is being used, or prompt the proper cassette setup for such a system, and load the program to be LLISTed.
3500-3510	the subroutine that waits for a key press and is accessed by almost all of the input prompts.

(Questions or comments about this program may be directed to the author at 310 S. Jefferson St., Sturgis, MI 49091. Please enclose an SASE when writing for a reply.) □

53028 2650151
 1540193 END202
 252061

The listing: BESTLIST

```

10 *****
20 **      LLIST FORMATTER      **
30 *****
40 **      BASIC LOADER FOR      **
50 **      FLIST/BIN             **
60 **      ML CODE BY C.ROSLUND  **
70 **      DECEMBER 1982 ISSUE   **
80 **      OF THE RAINBOW        **
90 *****
100 BD=1:POKE150,BD:** BAUD RAT
E **
110 A$=STRING$(32,188):B$=STRING
$(32,179)
120 DV=PEEK(188):ST=DV*256
130 FORX=ST TO ST+103:POKEX,&HFF
:NEXTX
140 IF DV=6 THEN C$="CASSETTE" E
LSE IF DV=14 THEN C$=" DISK":PO
  
```

```

KE&H95A,0
150 L$="* * * LOADING * * *":L1$
="READY PRINTER-LLIST AT OK PROM
PT"
160 *****
500 DATA 6F,8D,00,19,BE,01,68,AF
,8C,11,30,8C,11,BF,01,68,86,7E
510 DATA B7,01,67,86,39,A7,8C,EA
,39,00,00,00,34,17,D6,6F,C1,FE
520 DATA 27,06,35,17,6E,9D,FF,EF
,81,0D,26,06,6C,8D,FF,E9,20,F0
530 DATA 96,9C,81,50,25,13,86,0D
,BD,A2,BF,86,20,C6,04,BD,A2,BF
540 DATA 5A,26,FA,6C,8D,FF,CE,A6
,8D,FF,CA,81,3C,25,CF,C6,06,86
550 DATA 0D,BD,A2,BF,5A,26,F8,6F
,8D,FF,B8,20,BF,XX
560 *****
1000 CLS:PRINT:PRINT:PRINTA$;
1010 PRINT"          **** MAIN MENU
****"
1020 PRINTA$;
1030 PRINT:PRINT"          <1> SET P
RINTER BAUD"
1040 PRINT:PRINT"          <2> CHANG
E DEFAULTS"
1050 PRINT:PRINT"          <3> LLIST
  
```

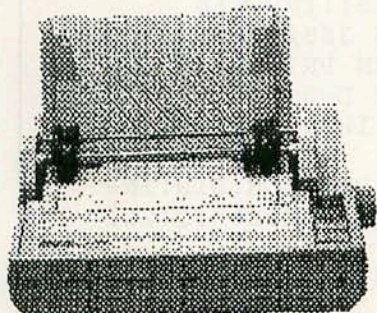

Hardware

2 Drive System(2 DSDD Drives in one case) \$329.95
 Drive 1 Upgrade(1 DSDD for your 26-3129 or 3131) Specify Catalog# when ordering !! \$119.95
 Drive 0-SSDD Full Height \$209.95
 Drive 1-SSDD Full Height \$135.95
 COCO 3 512K Upgrade(New Low Price)-\$99.95
 COCO 3 Keyboard \$34.95

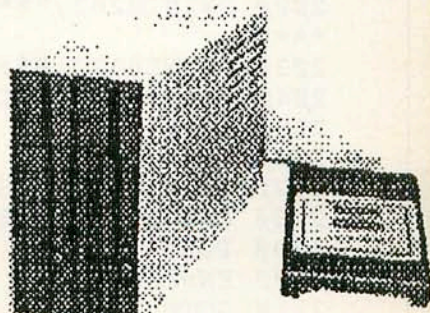

Software & Misc.

Art Deli(440 Pix on 10 disks) \$99.95
 COCO Graphics Designer \$29.95
 ADOS - \$29.95 ADOS 3 - \$39.95
 Monitor Interface \$29.95
 Serial to Parallel Converters \$54.95
 FKEYS III - \$19.95 Sixdrive - \$19.95
 Telewriter 64 - \$59.95 COCO-Util - \$39.95
 Gauntlet - \$28.95 Pyramix - \$24.95
 Disto Super Controller \$99.95
 COCO in Stitch (X-Stitch Patterns)- \$ 3.95

Epson LX-800
Printer
\$219.95
 180 CPS - DRAFT
 30 CPS - NLD
 3K BUFFER
 REQUIRES SERIAL TO
 PARALLEL INTERFACE

Specify R.S. or Disto Controller.

The Computer Center

IF YOU DON'T SEE IT, ASK US!

5512 Poplar Ave. Memphis, TN 38119 901-761-4565

Add \$4.90 for Shipping & Handling. VISA, Master Card, & Money Orders Accepted.
 Allow 3 Weeks for personal checks, NO CODS. Prices may change without notice.

ALL DISK DRIVES CARRY A 90 DAY WARRANTY.



```

PROGRAM"
1060 PRINT:PRINTB$;
1070 GOSUB 3500
1080 A=VAL(Q$):IFA<1 OR A>3 THEN
1090 ON A GOSUB 1500,2500,3000
1100 '*****
1500 CLS:PRINT:PRINT:PRINTA$;
1510 PRINT"      **** BAUD MENU
****"
1520 PRINTA$;
1530 PRINT:PRINT"      <1> -
600"
1540 PRINT"      <2> - 1200"
1550 PRINT"      <3> - 2400"
1560 PRINT"      <4> - 4800"
1570 PRINT"      <5> - 9600"
1580 PRINT:PRINTB$;
1590 GOSUB 3500
1600 Q=VAL(Q$):IFQ<1 OR Q>5 THEN
1610 E$="08741180701"
1620 BD=VAL(MID$(E$, (Q*2), 2))
1630 POKE 150, BD
1640 GOTO 1000
1650 '*****
2000 CLS:PRINT@128, A$;
2010 PRINT@198, "***** READING **
****"
2020 PRINT@262, "***** D A T A **
****"
2030 PRINT@320, B$;
2040 PRINTTAB(11) C$:PRINTB$;
2050 EN=ST
2060 READ D$
2070 IF D$="XX" THEN 2120
2080 C=VAL("&H"+D$)
2090 POKE EN, C
2100 EN=EN+1
2110 GOTO 2060
2120 RETURN
2130 '*****
2500 IF PEEK(ST)<>&H6F THEN GOSU
B 2000
2510 CLS:PRINT:PRINT:PRINTA$;
2520 PRINT"      **** DEFAULT MENU
****":PRINTA$;
2530 PRINT:PRINT"      <1> - COLUMN
WIDTH ---->"PEEK(ST+57)
2540 PRINT"      <2> - INDENTATION -
---->"PEEK(ST+68)
2550 PRINT"      <3> - PRINTOUT LENG
TH ->"PEEK(ST+84)
2560 PRINT"      <4> - SKIP LINES --
---->"PEEK(ST+88)
2570 PRINT"      <5> - MAIN MENU"
2580 PRINT:PRINTB$;
2590 GOSUB 3500
2600 Q=VAL(Q$):IFQ<1 OR Q>5 THEN
2610 ON Q GOTO 2620,2630,2640,26
50,1000
2620 PRINT@217, ;:INPUTCW:IFCW<1
OR CW>255 THEN2620 ELSE POKEST+5
7, CW:GOTO 2510
2630 PRINT@249, ;:INPUTID:IFID<1T
HEN2630 ELSE POKEST+68, ID:GOTO 2
510
2640 PRINT@281, ;:INPUTPL:IFPL<1
OR PL>65 THEN2640 ELSE POKEST+84
, PL:POKEST+88, (66-PL):GOTO 2510
2650 PRINT@313, ;:INPUTSL:IFSL<1
OR SL>65 THEN2650 ELSE POKEST+88
, SL:POKEST+84, (66-SL):GOTO 2510
2660 RETURN
2670 '*****
3000 IF PEEK(ST)<>&H6F THEN GOSU
B 2000
3010 CLS:PRINT:PRINT:PRINTA$;
3020 PRINT"      **** LLIST MENU
****":PRINTA$;
3030 IF PEEK(ST)<>&H6F THEN GOSU
B 2000:GOTO 3010
3040 IFDV=14 THEN F1$=" FILENAME
/EXT" ELSE F1$=" FILENAME"
3050 PRINT@384, B$;
3060 PRINT@192, F1$;:INPUTF$
3070 IFDV=14 THEN 3080 ELSE 3130
3080 IF F$="" THEN PRINT@210, "di
rectory":D=1 ELSE D=0
3090 PRINT@224, ;:INPUT" DRIVE NU
MBER - ";DN
3100 IF D=1 THEN DRIVEDN:DIR:INP
UT"      PRESS <enter>";Q:GOT
O3010
3110 PRINT@294, L$:PRINTL1$;:PRIN
T@416, ;:
3120 EXECST:DRIVEDN:LOAD F$
3130 PRINT@224, ;:INPUT" READY CA
SSETTE - <enter>";Q
3140 PRINT@294, L$:PRINTL1$;:PRIN
T@416, ;:
3150 EXECST:CLOAD F$
3160 '*****
3500 Q$=INKEY$:IFQ$=""THEN3500
3510 RETURN
3520 '*****
3530 '** BASIC LOADER BY: **
3540 '** CLAY HOWE **
3550 '** STURGIS, MICHIGAN **
3560 '** (616)-651-4248 **
3570 '*****
3580 '** NOVEMBER 1985 **
3590 '*****

```

DIGISECTOR DS-69B **NEW** VIDEO DIGITIZER FOR THE COCO 3 (AND ALL OTHER COCOS . . .)

**SUPER
RESOLUTION !!!**



COCO 3 SCREEN

USE YOUR COCO 3 TO ITS FULL POTENTIAL!

Use The Micro Works' DIGISECTOR™ DS-69 or DS-69B and your COCO 3's high resolution graphics to capture and display television pictures from your VCR or video camera. The DIGISECTOR™ systems are the only COCO video digitizers available that accurately capture and reproduce the subtle shades of gray in TV pictures!

- **COLOR:** Add color to your screen for dramatic special effects.
- **HIGH RESOLUTION:** 256 by 256 spatial resolution.
- **PRECISION:** 64 levels of grey scale.
- **SPEED!** 8 images per second on DS-69B, 2 images per second DS-69.
- **COMPACTNESS:** Self contained in a plug-in Rompack.
- **EASY TO USE:** Software on disk will get you up and running fast!
- **COMPATIBLE:** Use with a black and white or color camera, a VCR or tuner.
- **INEXPENSIVE:** Our low price puts this within everyone's reach.

POWERFUL C-SEE 3.3 SOFTWARE

This menu-driven software will provide 5 and 16 shades of gray to the screen and to the printer with simple joystick control of brightness and contrast. Pictures taken by the DIGISECTOR™ may be saved on disk by C-SEE 3.3 and then edited by our optional MAGIGRAPH, or by COCO MAX or GRAPHICOM. This versatile new software is included in both DIGISECTORS™



DS-69B and C-SEE 3.3	\$149.95
DS-69 and C-SEE 3.3	\$ 99.95

TRADE IN YOUR OLD DIGISECTOR™

If you already have one of The Micro Works' DS-69 or DS-69A DIGISECTORS™, you may return it to us and we will upgrade your unit to a DS-69B.

UPGRADE DS-69A to DS-69B	\$49.95
UPGRADE DS-69 to DS-69B	\$69.95

The DS-69B comes with a one year warranty. Cameras and other accessories are available from The Micro Works.

NO RISK GUARANTEE

If you are not completely satisfied with the performance of your new DS-69B, you may return it, undamaged, within ten days for a full refund of the purchase price. We'll even pay the return shipping. If you can get any of our competitors to give you the same guarantee, buy both and return the one you don't like. We know which one you'll keep.

Purveyors of Fine Video Digitizers Since 1977.

**THE
MICRO
WORKS**

Terms: Visa, Mastercard, Check or C.O.D.

P.O. Box 1110 Del Mar, CA 92014 (619) 942-2400

PRINTER OVERVIEW

By Ed Ellers

Rainbow Technical Editor

You might think the typical RAINBOW reader would have upgraded his or her system to include a 512K CoCo 3, an RGB monitor, a 1200 baud modem and a dot matrix printer, but a lot of our readers are just starting out and haven't worked their way up yet. It is still probably safe to say the typical CoCo user either has a printer, wants to buy one, or wants to upgrade to a better one. Rather than try to give a detailed buyer's guide, this will be an overview of the six basic types of printers (dot matrix, daisy wheel, laser, thermal, ink-jet and pen plotter) that CoCo users might be interested in, with an explanation of common features and what to look for.

Dot Matrix

This is the most popular type of printer among CoCo users, as well as the most common type of printer for personal computers in general. Why? Because it's also the most versatile type of printer; a good dot matrix printer can

Ed Ellers, a RAINBOW and PCM staff member, is a self-confessed electronics fanatic who takes time off to pursue other interests including science fiction.

usually serve all but the most specialized applications you may have for a printer.

Dot matrix impact printers use a series of wires in the print head to transfer the image through an inked ribbon to the paper. This type of printer is versatile because it's not limited to printing a fixed set of characters; it can also print any image that can be converted to a dot pattern. A typical dot matrix printer uses this capability to print both "bit-image" graphics that are fed into the printer and various sizes of type, ranging from type so small that it can barely be read to type big enough for almost any headline.

The most common difference between printers is the available resolution, and that usually depends on the number of wires in the print head. A low-end printer like the Tandy DMP-130 will usually have a nine-wire print head; since the wires in a print head normally extend over a one-eighth inch area, this works out to 72 dots per inch. Resolution can be extended by multiple-pass printing to a typical limit of 216 dpi, though this does tend to slow down the printing process. The high-speed print modes of such a printer typically use a 7-by-9 character set,

giving rather coarse "computer-style" type; but the trend in recent years has been to add a two-pass "near letter-quality" mode that provides a more attractive 14-by-18 font. Most nine-wire printers today have this feature.

More expensive printers often have an 18- or 24-wire print head, which gives higher resolution and greater speed than a nine-wire printer. The 18-wire type, such as the Okidata Microliner 292, gives the same resolution at full speed as a nine-wire printer would when slowed down; at higher resolutions (288 dpi is practical here) they do slow down somewhat. The 24-wire printers give even better resolution; 360 or 384 dpi is not unheard-of here, and that's starting to get into laser territory. Some corporations are using 24-pin printers for important correspondence, because their character sets aren't so easily identified as having come from a computer. (High-quality carbon film ribbons, like the ones used with office typewriters and daisy wheel printers, are becoming available for dot matrix printers.)

The other new feature that's starting to catch on, though slowly, is color printing. Some of the latest dot matrix printers can use a four-color ribbon

Computer Island Educational Software

BEYOND WORDS

32K Ext. - \$19.95 tape/\$24.95 disk
These Language Arts programs cover common misspellings, and synonyms/antonyms on each level. Additionally, Level 1 tests contractions and abbreviations, Level 2 tests homonyms, and Level 3 tests analogies. Each program has three parts and contains over 400 questions and uses over 800 words. All tests are grade appropriate. User modifiable (directions included). Printer option. Specify Level.

- Level 1 Grades 3-5
- Level 2 Grades 6-8
- Level 3 Grades 9-12



VOCABULARY BUILDER

32K. Ext. - \$19.95 tape/\$24.95 disk
200 Vocabulary questions on appropriate grade levels in a 4 part multiple choice format. 1000 words used. Extensive research has provided challenging words on all levels. When mastered, the words may be changed by the user (full directions included). Printer option. Specify Level.

- Level 1 Grades 3-5
- Level 2 Grades 6-8
- Level 3 Grades 9-12

CONTEXT CLUES - 4, 5, 6, 7

16K Ext. - \$17.95 tape/\$22.95 disk
Each reading program contains about 50 situational paragraphs with one key word missing. Child uses context clues to find correct answer in multiple choice format. Random selection of readings each round. Specify 4th, 5th, 6th, or 7th grade.

CONTEXT CLUES - 2-3

32K Ext. - \$19.95 tape/\$24.95 disk
A reading program wherein the child uses the context to choose the correct answer. Multiple choice format. Hi-res screen. Grades 2-3.

TRIGONOMETRY TUTOR

32K Ext. - \$19.95 tape/\$24.95 disk
A step by step tutorial for learning to compute the sides and angles of right triangles. All examples have graphic representation. Help commands and cursor aids assist throughout.



OPENING A BANK ACCOUNT

32K Ext. - \$24.95 disk only
A set of programs designed to introduce and provide practice in the skills of filling out bank applications, deposit and withdrawal slips, and computing bank account balances. Loaded with graphic presentations. Grades 3-6.

EQUATIONS TUTOR

32K Ext. - \$19.95 tape/\$24.95 disk
Elementary-Intermediate algebra. Step by step tutorials. Multi-level. SPECIFY Linear or Quadratic.

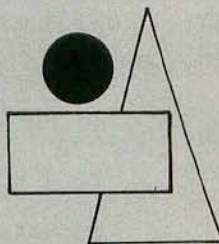

AREA & PERIMETER

32K Ext. - \$19.95 tape/\$24.95 disk
Triangles, rectangles, and circles and covered in this Hi-res text and graphic program.

COCO WHEEL OF FORTUNE

32K Ext. - \$19.95 tape/\$24.95 disk
Hi-res graphics and screen in this version of the popular TV show. One to six players. Spin the wheel for points and guess a letter to solve the puzzle. Over 200 puzzles. Have fun while strengthening language arts skills.

MATH INVADERS

32K Ext. - \$17.95 tape/\$24.95 disk
A multi-level "Space Invaders" type game to reinforce the 4 basic math operations (addition, subtraction, multiplication and division). Problems become more difficult as your progress. Hi-res graphics. Joystick required.



(718) 948-2748



Dept. R 227 Hampton Green, Staten Island, N.Y. 10312

Send for catalog with complete descriptions.

Please add \$1.00 per order for postage. N.Y. residents, please add proper tax. FREE set of BINARY DICE, including full directions, with orders of 2 or more items.

Dealer Inquiries Invited.

TRS-80 Color Computer

All Payments in U.S. Funds.

(black, yellow, magenta and cyan) that moves up and down on command. Although this type of printing is fairly slow, requiring four times the number of passes as a straight black-and-white printout, amazingly good results can be obtained. (These printers generally will accept a standard black ribbon that can be used for normal work, so that you don't waste the color ribbon by using up the black portion prematurely.)

As for compatibility, the Epson printer code set is so well accepted these days — even by IBM, whose standard printer codes are similar to those of Epson printers — that almost all dot matrix printers, including the present Tandy line, support either Epson or IBM printer control codes. New CoCo software packages often support Epson printers and compatibles as well, so most of the printers you'll come across should work well with the Color Computer. On the hardware side, most of Tandy's dot matrix printers (all but the most expensive models) do support the CoCo's serial I/O port, though the speed is limited to a typical value of 1200 or 2400 baud. With other brands of printers you'll need either an RS-232 board that mounts inside the printer (and which is only available for some printers) or an external serial-to-parallel converter box, like the ones from Metric Industries and Dayton Associates, that just connects between the CoCo and a parallel printer.

Daisy Wheel

These printers (and some related types, such as the NEC Spinwriter and IBM Selectric) used to be the most common way to obtain letter-quality text, because they print actual characters from a type element rather than bit images. Unfortunately, they tend to be rather slow and noisy, and for that reason (as well as their inability to print graphics images well) they're being

steadily replaced by the better dot matrix printers and by laser printers. If you do have a real need for letter-quality type, some daisy wheel printers are selling for under \$300 these days; but you might also consider putting the

both the IBM Proprinter and Tandy's dot matrix printers) and can therefore be used reasonably well with the CoCo as long as you can set the printer for the auto line feed mode that the CoCo uses. Some laser printers (such as HP) won't allow this mode change at all, so check the manual before buying.

Thermal

These printers were introduced a number of years ago in an attempt to produce a less expensive type of printer. The original thermal printers required special (and somewhat expensive) paper and produced relatively poor printouts, so they quickly fell from favor as soon as dot matrix printer prices became more competitive. A variation on the basic theme is the thermal transfer printer, which uses a special ribbon to print on plain

paper; the Okimate 10 and 20 are examples of this type of printer, which can also be used with thermal paper. The major advantage of thermal transfer printers (aside from somewhat lower cost) is their very low noise level.

Ink-Jet

These printers use a thin jet of ink to draw a bit image on paper. They were originally developed to provide a low-cost way to print multiple-color images (as in the now-discontinued Tandy CGP-220), but most of the ones still on the market, such as the HP ThinkJet, are used in applications where low noise levels are needed, such as in search-and-retrieval systems in libraries.

Pen Plotters

These have long been used in engineering applications to make detailed drawings, but with one exception — the Tandy CGP-115 introduced a few years ago — they haven't made much of a dent in the personal computer market. Their main drawback is the rather poor text they produce, since they "draw" the characters as a series of pen strokes. ☺

Laser Printer (Courier type)

The quick brown fox jumped over the lazy dog's back.

Daisy Wheel Printer (Courier type)

The quick brown fox jumped over the lazy dog's back.

9-Pin Dot Matrix Printer (Two-Pass NLQ Mode)

The quick brown fox jumped over the lazy dog's back.

9-Pin Dot Matrix Printer (Speed Mode)

The quick brown fox jumped over the lazy dog's back.

24-Pin Dot Matrix Printer

The quick brown fox jumped over the lazy dog's back.

Figure 1

money toward a high-quality dot matrix unit instead.

Laser

Laser printers have become increasingly popular in recent years as a high-quality, highly flexible way of printing text and graphics. These printers combine a scanned laser beam and a copier mechanism, creating a bit image in RAM and then using a solid-state laser to draw that image on the copier drum, which then transfers the image to plain paper in the usual copier fashion. Even though prices have come down somewhat within the past year, they still normally run over \$2,000 and would therefore seem to be a bit expensive as an adjunct to a Color Computer system.

Nearly all of the less-expensive laser printers are designed to emulate the Hewlett-Packard LaserJet Plus, although in many cases (Tandy's LP-1000, at \$2,199, being one of them) the printer either does not accept HP font cartridges or doesn't use cartridge fonts at all. A number of these printers also emulate either Epson or IBM dot matrix printers (the LP-1000 emulates



Making the **MicroWorld** of

CoCo's AFFORDABLE

CoCo III	\$145
Drive 0	\$175
Drive 0 (NEW)	\$199
CM-8 Monitor	\$248
Deluxe Joystick	\$ 24
Mouse	\$40
Joysticks (pair)	\$13
Disk storage box (50)	\$12.50
CCR-81 Cass. Rec.	\$42

Disks (SS)	\$7.00/box
Disks (DS)	\$7.50/box
*Includes free library case	
DMP-106	Special Offer \$145
DMP-130A (120 CPS)	\$265
DMP-440	\$545
Special Offer	
Tandy 1000 SX	\$499
Tandy 1000 HX	\$555
Tandy 1000 TX	\$899
VM-4 Monitor	\$ 99
CM-5 Monitor	\$240
CM-11 Monitor	\$325

CoCo 3 512K Upgrade	\$130
MultiPak Upgrade (26-3024)	\$ 10
MultiPak Upgrade (26-3124)	\$ 10
OS-9 Level 2	\$ 63.95

Minimum Order \$15.00

* Please Note - Our ads are submitted early, so prices are subject to change!!! We appreciate your cooperation & understanding in this matter.

Method of Payment:
MC, Visa, Am.Ex. - Sorry, No Citiline!
Certified Check or Money Order.
Personal Checks - Allow 1 week to clear!

FREE PRICE LIST AVAILABLE

20 % OFF ALL TANDY SOFTWARE
MIN. 15% OFF ALL TANDY HARDWARE

- * Full TANDY Warranty ==> CALL <== In Pa: 215 863-8911
- * 100% TANDY PRODUCTS In N.J.: 201 735-6138
- * FREE UPS Shipping †on orders over \$50.00 under \$50 add \$2.00



COMPUTER CENTER

MicroWorld

230 Moorestown Road, Wind Gap, PA 18091

Laneco Plaza, Clinton, N.J. 08809

C.O.D. ADD \$5.00

ALL PRICES INCLUDE SHIPPING †!!!
(In Continental US)

100% TANDY EQUIPMENT WITH FULL RADIO SHACK WARRANTY

Transferring centered headings to the DMP-110

Center That Header

By Doug Anderson

Centering a heading is easy enough on the video monitor: Just use the PRINT TAB or PRINT@ commands. Transferring a centered heading onto your printer may require more work, however. In this tutorial, you'll get a simple one-line subroutine, plus the necessary background to successfully incorporate this into your own programs.

Unless you are using special fonts (like elongated italics), you can use the following command:

```
PRINT TAB(80-LEN(R$)/2)R$
```

This will work in any case where you are using standard printing (and if your printer has an 80-character line). In other cases, where the length of the line differs, you may need something that

looks a little more elaborate (but really isn't):

```
10 R=LEN(R$)
20 S=R*Z
30 T=960-S
40 U=T/2
50 N1=U/256
60 N1=INT(N1)
70 N2=U-(N1*256)
80 PRINT #2, CHR$(27);CHR$(26);CHR$(N1);CHR$(N2);R$
```

This really isn't as intimidating as it looks. We'll break it down step by step. First, a word of caution: This works on a CoCo 2 with a DMP-110 printer. If you have other equipment, you'll need to change some of the parameters that appear in this tutorial. We'll explain as we go along.

The first step is to ascertain the total width of the printed line (in dots). For the DMP-110, this is 960 dots. If you have another type of printer, the value may differ. Check your printer manual.

The second step is to determine the

width of the character that you will be using. This is the value of Z in Line 20. For a DMP-110, a standard character is nine dots wide; italics are 12 dots wide, and elongated characters are twice the usual width (18 for standard print, and 24 for elongated italics). If you will be using only one type font for your headers, just replace Z with an appropriate value. Otherwise, specify a value for Z within the program.

In this tutorial, R\$ is the line that we want to print on the form we are designing. We want to center R\$. So, the first step is to find the length of the line (the number of characters). We find this from 10 R=LEN(R\$).

Next, we want to find the length of R\$ as measured by the number of dots each character will occupy in the line. Let's say that we want to print our heading in elongated italic type. As we learned above, each character in elongated italic is 24 dots wide. Thus, 20 S=R*Z.

Now, we want to find the total

Doug Anderson is an attorney who loves computers, roses and science fiction.

number of spaces left over on the line after we have printed our string. On the DMP-110, the total length of the line is 960 dots. From Line 20, the value of S is the total number of dots our heading will use. Thus, the amount of blank space will be $30 T=960-S$.

To center the string, we want a value that is one-half of the value of T derived from Line 30. The next calculation that we need to perform is $40 U=T/2$.

The value of U in Line 40 is the amount of space that we need to TAB in order to center our header. However, we need to transform this value into two numbers that the printer will recognize. For the DMP-110, the print command is:

```
80 PRINT#-2,CHR$(27);CHR$(16);
CHR$(N1);CHR$(N2);R$
```

Those of you who are familiar with printer codes will recognize that the first part of the command tells the printer we want to center R\$. (For the rest of us, it's that part of Line 80 that reads: PRINT#-2,CHR\$(27);CHR\$(16);).

The last half of this command, CHR\$(N1);CHR\$(N2);, is our next

concern. This gets a bit complicated, so reread the next couple of paragraphs until you are comfortable with what we are going to do. If you need additional help, check your printer manual, or *How to Use Your Radio Shack Printer*, by William Barden, Jr.

The value N1 is a multiple of 256. N2 is the remainder. Together, these values tell the printer how far to TAB. We determine the value of N1 by finding out how many times 256 may be divided into the value of U (which we determined in Line 40). This calculation is $50 V=U/256$.

Because N1 must be an integer, we need Line 60: $60 N1=INT(V)$. N2 is the remainder. This is the difference between $N1*256$ and U (the amount of space we want before we start printing R\$). Therefore, $70 N2=U-(N1*256)$. If it's easier, you might want to think of the N1/N2 combination as a number expressed in Base 256.

Let's look at these steps again.

```
10 R=LEN(R$):REM THE NUMBER
OF CHARACTERS IN R$
20 S=R*24:REM 24 IS THE
LENGTH OF EACH CHARACTER IN
ELONGATED ITALIC
```

```
30 T=960-S:REM THIS IS HOW
MUCH SPACE IS LEFT OVER AFTER
WE PRINT R$
```

```
40 U=T/2:REM THIS IS THE
NUMBER OF SPACES BEFORE WE
START PRINTING A CENTERED R$
50 N1=U/256:REM HOW MANY
TIMES CAN 256 BE DIVIDED
INTO U
```

```
60 N1=INT(N1):REM N1 HAS TO
BE AN INTEGER
70 N2=U-(N1*256):REM N2 IS
THE REMAINDER
80 PRINT#-2,CHR$(27);CHR$(
16);CHR$(N1);CHR$(N2);R$
```

When we put it all together, it looks like this:

```
100
R=LEN(R$):S=R*24:T=960-S:U=T/
2:V=U/256:N1=INT(V):N2=U-(N
1*256):PRINT#-2,CHR$(27);
CHR$(16);CHR$(N1);CHR$(N2)
;R$
```

(Questions or comments regarding this tutorial may be directed to the author at 1038 NE 21st St., Apt. 24, Hillsboro, OR 97124. Please enclose an SASE when requesting a reply.)

New, Lowest Prices Ever On Interfaces

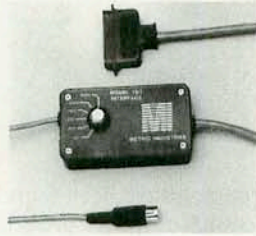

Model 101 Serial to Parallel Printer Interface

- ★ Works with any COCO
- ★ Compatible with "Centronics" Parallel Input Printers
- ★ Just turn the knob to select any one of 6 baud rates 300-9600
- ★ Comes complete with cables to connect to your printer and computer
- ★ Can be powered by most printers



Model 104 Deluxe Interface with "Modem Switch"

- ★ Same Features as 101 Plus
- ★ Built in Serial Port for your Modem or other serial device
- ★ Switch between Serial Output and Parallel Output
- ★ Comes with cables to connect to your computer and printer
- ★ Can be powered by most printers



Model 105 Serial Switch

- ★ Connects to your COCO to give you 2 switch selectable Serial Ports
- ★ Comes with a 3 foot cable to connect to your computer
- ★ Now you can connect your Printer (or printer interface) and your Modem (or other serial device) to your COCO and flip the switch to use either device
- ★ Does not require power



Cassette Label Printing Program

- ★ New Version 2.1 prints 7 lines of information on Cassette labels
- ★ Comes on Tape with instructions to transfer to disk
- ★ Menu driven, very easy to use
- ★ Save and Load Labels from Tape and Disk
- ★ Uses the features of your printer to print standard, expanded, and condensed characters
- ★ Automatically Centers Each Line of Text
- ★ Allows editing of label before printing
- ★ Program comes with 24 labels to get you started
- ★ 16K ECB required

Some of the Printers That Can -

Supply power for the 101 and 104 are Radio Shack, Star, Okidata, Brother, Juki, and Smith Corona.

Some of the Printers That Cannot -

Supply power for the interfaces are Epson, Seikosha, Panasonic, Silver Reed and NEC. If your printer cannot supply power to the interface you can order your interface with the "P" option or you can supply your own AC adapter. We recommend the Radio Shack 273-1431 AC adapter with a 274-328 connector adapter.

Write or call for more information or for technical assistance.

Price List

Model 101	35.95
Model 101P	41.95
Model 104	44.95
Model 104P	51.95
Model 105	14.95
Cassette Label Program	6.95
Pin Feed Cassette Labels:	
White	3.00/100
Colors (specify)	3.60/C
Red-Blue-Yellow-Tan	
C-10 Cassette	
Tapes	7.50/dozen
Cassette Storage	
Boxes	2.50/dozen
4 Pin Din Serial	
COCO Cables:	
Male/Male 6 foot	4.49
Male/Female 6 foot	4.49
Female/Female 6 foot	4.49
Other Lengths Available.	

All items covered by a 1 year warranty

Ordering Info

- ★ Free Shipping in the U.S.A. and Canada (except AK and HI) on all orders over \$50
- ★ On orders under \$50 please add \$2.50 for shipping and handling
- ★ On orders outside the U.S.A. and Canada please write or call for shipping charges

You Can Pay By:

- ★ VISA or MasterCard
- ★ C.O.D. - add \$2.25
- ★ Or send check or money order payable in U.S. funds

Metric Industries Inc.
Cincinnati, OH 45242
P.O. Box 42396
(513) 677-0796



RAINBOWfest
Chicago '88
May 20-22

Sample printout

Bulletin Board Standout

By George Quellhorst

For several years, I have been searching for a Color Computer program to print a neat little bulletin board-type poster as opposed to the many banner printers floating around.

Never once did I have the inclination to write such a program myself, until Radio Shack put the DMP-130 printer on sale, and I saw all those small triangles and squares built into the printer's ROM, the perfect building blocks for alphanumeric characters. The result is this program, which uses the graphics blocks of the DMP-130 to form every keyboard character, except one, to print those little posters.

When the program was first written, it would only work on the Color Computer 3, but I have reworked the program into two parts sharing the same

George Quellhorst lives in Painesville, Ohio, and has had a CoCo since the 4K days. He enjoys writing programs on his two CoCo 2s and a CoCo 3 with RGB monitor.

DATA statements and printing routines. One makes use of the 32-column screen and the inverse video of the Color Computer 1 and 2, and the other takes full advantage of the CoCo 3's 40- and 80-column screens with the true lowercase.

The Program

With the exception of the left, right and down arrows, all the keyboard characters are printable, including the SHIFT-CLEAR or reversed slash. The SHIFT-up arrow is used as the only control key in the program.

A total of 98 "blocks," or modules of six graphics characters, were needed to construct all of the characters on the keyboard. The sixth one in each module is CHR\$(224) or a space. By changing the printer codes, a total of four different character widths, or line lengths, are available. Making the spaces between characters part of each character results in a space between characters that is always proportional to the character being printed. Therefore, the resulting final product will have nice uniform spacing at any character width or line length.

Lines 100 through 112 contain the data for our modules, which are read in the first part of Line 279. After the data is read, we have 98 variables in memory, each containing a group of six graphics characters, A\$(X,Y), the last one being A\$(98,6).

Lines 150 through 240 hold the DATA statements for each one of the 90 characters this program is capable of printing. For example, Line 201 is the capital 'S'. In order to print an 'S', modules 1,14,14,34,15,15,4,11 and 11 have to be printed. The second half of Line 279 puts the variables for each of the 90 characters in memory using the variable L(X,Y), L(90,9) being the last one (the lowercase 'z').

The first printable character is the exclamation mark or CHR\$(33). The last one is the lowercase 'z' or CHR\$(122). By putting the character data in order of their ASCII value, all we have to do is subtract 32 from this in order to be able to read the corresponding DATA statement for any given character. We do that in Line 19 of the program.

If we just had to print a single character, this program would be done by now. However, we may have to print up to 22 characters across the width of the paper. In that case we have to print the top module of each of the 22 characters, do a line feed, and go back to print the

next row of 22 modules. This process is repeated until all 22 characters on the first line of the poster are printed. If you have trouble visualizing multidimensional arrays, I recommend you check out the program by Robert E. Laun in the April 1987 RAINBOW called "Enter the Fifth Dimension." This will give you a good idea as to how this program works, since we are dealing with a four-dimensional array.

BASIC programming can be a lot of fun, once you teach yourself how to "think" like a computer.

The Input Sections

Up to 11 lines of material may be printed on a single sheet of printer paper, in line widths of 8, 13, 16 and 22 characters per line. The height, however, will remain constant. By changing

the printer codes, the width of each character is either elongated or compressed. Therefore, an eight-column character is twice the width of a 16-column character.

When I was working on the input section, it occurred to me that it would be nice if you could design and lay out an entire poster before it was actually printed. On the wide 80-column screen of the CoCo 3, it was easy enough to do. The 32-column screens on the CoCo 1 and 2 were a little harder, however. The layout alone consumes the entire 32-column screen.

Since some of the early model CoCos would not work with the speed-up poke, it is not in effect in the CoCo 1 mode.

The CoCo 3 has to be in the CoCo 2 or 32-column screen mode when the program is run for the first time. The



Sample printout (reduced 60 percent)

title screen asks you to press 1, 2 or 3 to indicate which model you have. Depending on the number entered, the program then switches to either a 32- or 80-column input screen.

The input screen displays the numbers 1 through 11 and a cursor immediately behind the number 1. The first thing you must enter is the line width for the first line. Take into consideration what you want to print and how big you want your letters to be. For example, if the first line is a header and all you want to print is "SALE," use the largest character available to make it stand out better. The line width input will not accept anything other than 08, 13, 16 or 22. I wrote it that way since 23, for example, would result in an FC or OD Error, should you try to print your poster. Note that you must enter a leading 0 before the 8.

After you type in the line width and press ENTER, the program will print two brackets on the screen immediately behind this number. The spaces between the brackets equal the line width plus one. If you type the word SALE and press ENTER, *Poster Printer* will center "SALE" on your printer paper. However, pressing ENTER just before the right bracket prints the word "SALE" on the left side of the paper. Therefore, to center a word or sentence, press ENTER immediately after that word or phrase. To justify left, press ENTER in front of the last bracket.

To print an "empty line," enter any line width and press ENTER-ENTER. Presto! A line containing nothing but spaces is entered. To stop the input and start printing a poster, enter any line width and press the SHIFT-up arrow and ENTER. The screen will show a left arrow, and the program will be routed to a display screen. You'll be asked whether or not you want to print.

Line up the perforation on your paper with the print head, and the poster will also be centered vertically. Once the first poster is printed, the paper will line itself up to print the next one.

Once your poster has been printed, you have three options. You may print the same poster again, enter a new poster, or quit.

Line 273 starts the 32-column screen input. POKE282,0 puts your computer in the lowercase mode. A POKE282,255 returns it to all uppercase. The next line prints the numbers 1 to 11 and the available line widths on the screen. Since we want to be able to lay out an entire poster at one time, we must put

all of the inputs inside a FOR-NEXT loop in order to assign a variable to each line. Line 274 does that.

Our first input is B\$(F), the line width. This is used to calculate the margin in conjunction with the length of the next input, A\$(F), which is the actual text for the first line. The last part of Line 275 checks to see if you entered a valid line length. Line 276 makes sure your input is not a CHR\$(95) or SHIFT-up arrow. If it is, your input is terminated, and the program jumps to Line 278, which restores the uppercase, resets the speed-up poke and creates a flag, CT=1, to let the program know that it is in the CoCo 2 mode. If A\$(F) <> CHR\$(95), then S=S+32:NEXTF adds 32 to S, the next input's printout location, and routes the program back to get the second line of the poster we are creating.

Once you have typed in 11 lines of copy or entered a CHR\$(95), the input is finished. All the variables we need to print the poster are in memory, and lines 9 to 13 display the input on the screen. You are asked if you want to print this poster the way it was entered. If you do not, we return to Line 273 to start over again. If you do, all sorts of things happen.

First of all, your printer may still be in its elongated mode from printing a previous poster or line. This command must be cancelled, just in case your next line does not need elongation. Second, we have to send a half-forward line feed. Because this has to be done each time a new line is printed, the printer codes are placed inside the FOR-NEXT loop that does the actual printing. We created two new variables in Line 9, PC(D) and LC(D). PC(D) is the line width and LC(D) is the line length for the line being printed.

In Line 15, DQ determines the position of the print head at the start of each line. Presuming a line length of 13, the program does a GOSUB304, thus sending out the control codes for the line width wanted, in this case a standard 10 cpi character. By taking a look at the printer handbook, we see that in this mode there are a total of 960 dots across the width of the paper, of which every other one can be addressed, leaving us with $960 \div 2 = 480$ dots. By printing a line full of characters, we discover that it requires 13 poster characters to fill a page from left to right. Therefore, one character is $480 \div 13 = 36$ dots wide. In order to calculate the left margin and center this line on your paper, multiply LC(D), the line length, by 36 and sub-

tract the result from 480. After this is divided by 2, we have our variable DP, which will determine the start position of the print head when we return to Line 16.

Even though we have sent the start position of the print head to the printer, there are still a few things left to check before we can start with the actual printing of the first line. The program comes back to this same place every time a new line needs to be printed. Therefore, we must first make sure that there is something left to be printed.

A\$(D), our line to be printed, is checked in Line 17. If A\$(D)="", we are dealing with an empty line. FORI=1TO11:PRINT#-2:NEXTI takes care of that chore and the NEXTD in Line 23 routes us back for the next line.

Remember that CHR\$(95) or SHIFT-up arrow in the input section? Well, Line 18 checks for that and stops the printing in case A\$(D) happens to be CHR\$(95). This line also checks the value of CT, our flag that lets the program know what kind of computer you have. If CT=1, the program goes to Line 28, and if CT=0, it jumps to Line 24. In both cases, you'll have the three end options discussed earlier.

Printing the Poster

Lines 19 through 23 are the soul of *Poster Printer* because your entire poster is being printed in these four lines.

First of all, we should look at all the variables we told the computer to remember. Line 279, A(X,Y), the first thing read into the memory of our machine, holds the graphics used to construct characters. Since X=1TO98 and Y=1TO6, A(1, 1 through 6) will contain a block of six graphics characters. Ninety-eight such blocks are now in memory with the very last of these being A(98, 1 through 6), for a grand total of 98×6 or 588 separate graphics DATA statements.

Secondly, we have L(X,Y) containing the data for each one of the 90 characters this program is capable of printing. After this second READ statement, we also have L1 through L90 in memory, each holding nine-character DATA statements, L(1, 1 through 9) being the first character, the exclamation point and L(90, 1 through 9) being the last one, the lowercase 'z'. Thus, a total of 90×9 or 810 DATA statements.

If that were not enough, we also have cramped the entire poster in our poor computer's memory. The poster is

Still pounding away at that keyboard?



Save Time and Money with a Combination Subscription!

SAVE up to 19%

when you buy a joint subscription to the magazine and either RAINBOW ON TAPE or RAINBOW ON DISK! A one-year subscription to THE RAINBOW and RAINBOW ON TAPE is only \$91 in the U.S., \$108 in Canada, \$153 foreign surface rate and \$188 foreign airmail. A one-year subscription to THE RAINBOW and RAINBOW ON DISK is only \$115 in the U.S., \$138 in Canada, \$183 foreign surface rate and \$218 foreign airmail.*

Every month, these convenient services bring you as many as 24 ready-to-run programs. Using the current issue of THE RAINBOW as documentation, all you have to do is load and run them. A one-year combination subscription to THE RAIN-

BOW and RAINBOW ON TAPE or RAINBOW ON DISK give you more than 230 new programs! The typing time you save can be spent enjoying your CoCo!

RAINBOW ON TAPE For No-Fuss Fun

Back issues of RAINBOW ON TAPE are available beginning with the April 1982 issue. A single copy of RAINBOW ON TAPE is \$10 within the United States; U.S. \$12 in all other countries. The annual subscription rate for RAINBOW ON TAPE is \$80 within the U.S.; U.S. \$90 in Canada; and U.S. \$105 for all other countries.*

RAINBOW ON DISK Offers OS-9 Programs

In addition to all the programs offered on tape, part of one side of RAINBOW ON DISK is formatted for the OS-9 operating system. That means you can now get all the OS-9 programs from the magazine — programs that cannot be put on tape. Back issues of RAINBOW ON DISK are available beginning with October 1986. Subscriptions to RAINBOW ON DISK are \$99 a year in the U.S. Canadian rate is U.S. \$115. All other countries, U.S. \$130. Single copy rate is \$12 in the U.S.; U.S. \$14 in Canada; and U.S. \$16 in all other countries.*

To order by phone (credit card orders only), call (800) 847-0309, 8 a.m. to 5 p.m. EST. All other inquiries call (502) 228-4492.

Look for our envelope located between pages 66 and 67 for ordering individual subscriptions to THE RAINBOW, RAINBOW ON TAPE and RAINBOW ON DISK.

YES! Sign me up for a joint 1-year subscription (12 issues) to:

- THE RAINBOW and RAINBOW ON TAPE
 THE RAINBOW and RAINBOW ON DISK
 NEW RENEWAL (attach labels)

Name _____

Address _____

City _____ State _____ ZIP _____

Payment Enclosed (*payment must accompany order)

Charge: VISA MasterCard Am. Express

Account Number _____

Signature _____ Exp. _____

*U.S. currency only, please. In order to hold down costs, we do not bill. Kentucky residents add 5% sales tax. Please allow 6 to 8 weeks for delivery of first copies. Joint subscriptions to THE RAINBOW and RAINBOW ON TAPE or RAINBOW ON DISK begin with the current issue.

Please note: While group purchases of RAINBOW ON TAPE and RAINBOW ON DISK are permitted (and multiple subscriptions are even discounted, if purchased in one order from a club), no license to make copies is conveyed or implied. Yes, your group may even purchase a subscription to our disk/tape services, but such purchase in no way authorizes that any copies be made of that original disk/tape. Specifically, this means that the original disk/tape itself may indeed be kept in a club library for use by members. However, a group purchase *does not* entitle club members, individually or as a group, to copy that disk/tape.

Unauthorized copying of any copyright product is strictly illegal. The copyright (right to make copies) is in no way conveyed in the purchase transaction.

stored in A\$(1 through 11) where A\$(1) is the first line of our copy, and A\$(11) the last line. Now that all that stuff is loaded and stored in variables, we can bring it together and tell the computer to print our poster.

Because a single poster may contain up to 11 lines of copy, we use the first FOR-NEXT loop in Line 14, FORD=1TO11, to hold those lines. Then we open another FOR-NEXT loop inside the previous one for the nine lines of data each printed line requires, FORT=1TO9 in Line 16. Because this is the start of each of the nine lines of graphics data, the command that positions the print head is inserted next. FORQ=1TOLEN(A\$(D)), which is the third loop, simply states FOR Q=1 TO (the length of this line). The last one, FORY=1TO6, is for the six blocks of graphics that make up the modules we constructed earlier.

If we put all those loops within loops together, it would look like this: FORD=1TO11:FORT=1TO9:FORQ=1TOLEN(A\$(D)):FORY=1TO6:NEXTY:NEXTQ:NEXTT:NEXTD. As you may know, FOR-NEXT loops within FOR-NEXT loops are executed in reverse order. In our case, the computer will first count all the Ys, then the Qs, followed by the Ts, and finally the Ds.

Now we have all the information necessary to tell the computer what to print. Presuming the first line of our poster reads "SALE," the following occurs: Y=1, Q=1, T=1 and D=1. Since D is still equal to 1, A\$(D) is really A\$(1), in this case the word "SALE." If we take a look at Line 19, we see that V is the ASCII value of the first character in A\$(D)-32. V, therefore, is the ASCII

value of S-32 or (83-32)=51. The next time around, Q will be 2 and V will equal the ASCII value of M (D, 2, 1) or the second letter, the 'A'.

Line 20 does the actual printing: PRINT#-2,CHR\$(A(L(V,T),Y));. We have two arrays in memory containing data, the A array, which holds the data for the graphic characters, while the L array holds the data needed to print each keyboard character. The data we want to send to the printer is held within the A array. The value of V is like a pointer telling the A array which data to print. Since the character data is arranged in ascending order according to their ASCII value, and V equals 51, the 51st line in those DATA statements contains the information we need to print the letter 'S'. Remember all our variables in the FOR-NEXT loops are still one. L(51,T) is therefore the first number in that line, which is in this case a 1 (the data for the 'S' is in Line 201).

Now let's take another look at Line 20, replacing the L(V,T) in our mind with the number 1. The result is PRINT#-2,CHR\$(A(1),Y). Here again, Y still equals one, thus CHR\$(A(1,1)), which just happens to be the first DATA statement in the graphics data, is dumped to the printer.

NEXTY will print the remainder of the graphics blocks needed to print the top of the 'S'. After all the Ys are printed, we start with the Qs. Since Q is now 2, V will equal the ASCII value of the A. This continues until the whole top row of the word "SALE" has been printed and Q is equal to the length of A\$(D). As you know, we are using a 9-by-6 matrix; therefore, it will take nine passes to print "SALE." NEXTT finishes

printing the rest of our first line. NEXTD starts the whole thing all over again and prints lines 2, 3, 4, etc.

I would like to mention one more thing. Look at Line 19: IFV=0THEN PRINT#-2:CHR\$(32):GOTO 21. Because we subtract 32 from the ASCII value of our character, V will equal 0 only when the ASCII value of the character is 32 or a space. In this case, we have to print six "blocks" of spaces rather than graphics characters. The PRINT#-2,CHR\$(32) does just that; and since we GOTO 21 or NEXTY, six spaces will be printed, which is the exact width of a character.

Finally, if you look through the DATA statements, you will see two lines containing nothing but 0s. They are CHR\$(95) and CHR\$(96). One is the SHIFT-up arrow, which we use as our only control key. And the last one is the underline, which would be a printable character except that it is not a keyboard character; therefore, it cannot be used because there is no keyboard key that sends a CHR\$(95) to the printer. The 0s were needed to keep the count of V in line. Lines 300 to 307 are the printer code GOSUBS. You will notice a single- and double-strike line for each line width. You may change the line numbers in Line 15 to print your poster in the double-strike mode.

If you don't have an RGB monitor, change the PALETTEGB in Line 254 to PALETTECMP.

(Questions or comments regarding this program may be directed to the author at 63 South State Street, Painesville, OH 44077. Please enclose an SASE when writing for a response.) □

✓	10216	209205
	20141	225229
	3055	250215
	10469	256228
	10971	265200
	150117	277113
	167132	END113
	183245		

The listing: POSTRPTR

```
1 PCLEAR1: CLEAR20000: DIMA(98,6), L
(90,9), A$(11), B$(11), PC(11), LC(1
1)
2 POKE150,18: GOSUB250: Z$=STRING$(30,32)
3 CLS: LOCATE9,0: ATTR3,2: PRINT"PR
INT THIS <"; ATTR3,2, B: PRINT"Y";
```

```
:ATTR3,2: PRINT"> OR <"; ATTR3,2,
B: PRINT"N"; ATTR3,2: PRINT">O"; A
TTR1,0: LOCATE38,0
4 FORD=1TO11: PC(D)=VAL(B$(D)): LC
(D)=LEN(A$(D)): IFPC(D)=8THENB$(D
)="08"
5 D$=STR$(D): IFVAL(D$)<=9THEND$=
"0"+RIGHT$(D$,1) ELSE D$=RIGHT$(D$
,2)
6 K$="Line:"+D$+".( "+B$(D)+"): "
+A$(D): LOCATE2,(D*2): ATTR0,0: PRI
NTK$: NEXTD: ATTR1,0: LOCATE38,22
7 ATTR0,0: P$=INKEY$: IFP$="Y"THEN
8ELSEIFP$="N"THEN256ELSE7
8 PRINT#-2: PRINT#-2: LOCATE8,0: PR
INTZ$: LOCATE8,0: ATTR3,2, B: PRINT"
N O W P R I N T I N G"; ATTR1,
```

```

Ø:LOCATE38,Ø:ATTR1,Ø:GOTO14
9 S=64:CLS:PRINT@4,"PRINT THIS <
Y>ES OR <N>Ø":PRINT@32,STRING$(3
2,45);:FORD=1TO11:PC(D)=VAL(B$(D
)):LC(D)=LEN(A$(D)):IFPC(D)=8THE
NB$(D)="Ø8"
1Ø D$=STR$(D):IFVAL(D$)<=9THEND$
="Ø"+RIGHT$(D$,1)ELSED$=RIGHT$(D
$,2)
11 S=S+32:PRINT@S,D$;"."(;B$(D);
"):";A$(D):NEXTD
12 P$=INKEY$:IFP$="Y"THEN13ELSEI
FP$="N"THEN273ELSE12
13 PRINT#-2:PRINT#-2:PRINT@4,"N
O W P R I N T I N G";
14 FORD=1TO11:PRINT#-2,CHR$(27);
CHR$(28);CHR$(27);CHR$(15);CHR$(
27);CHR$(85);CHR$(Ø);
15 DQ=Ø:IFPC(D)=8THENGOSUB3Ø2ELS
EIFPC(D)=13THENGOSUB3Ø4ELSEIFPC(
D)=16THENGOSUB3Ø6ELSEIFPC(D)=22T
HENGOSUB3Ø7
16 FORT=1TO9:PRINT#-2,CHR$(27);C
HR$(16);CHR$(DQ);CHR$(DP);:FORQ=
1TOLEN(A$(D)):FORY=1TO6
17 IFA$(D)=" "THENFORI=1TO11:PRIN
T#-2:NEXTI:GOTO23
18 IFA$(D)=CHR$(95)ANDCT=1THEN28
ELSEIFA$(D)=CHR$(95)ANDCT=ØTHEN2
4
19 V=ASC(MID$(A$(D),Q,1))-32:IF
V=Ø THEN PRINT#-2,CHR$(32);:GOTO
21
2Ø PRINT#-2,CHR$(A(L(V,T),Y));
21 NEXTY:NEXTQ
22 PRINT#-2:NEXTT:PRINT#-2:PRINT
#-2
23 NEXTD:FORT=1TO9:PRINT#-2:NEXT
:CLS:FORT=1TO1Ø:SOUND18Ø,1:NEXTT
:IFCT=1THEN28ELSE24
24 CLS:LOCATE5,3:ATTR3,2:PRINT"Y
OU HAVE THE FOLLOWING OPTIONS";:
ATTR1,Ø:LOCATE38,Ø
25 LOCATE9,8:ATTRØ,Ø:PRINT"1. PR
INT ANOTHER COPY":LOCATE9,1Ø:PRI
NT"2. START A NEW POSTER":LOCATE
9,12:PRINT"3. QUIT":LOCATE9,16:A
TTR3,2,B:PRINT"PRESS NUMBER DESI
RED";:ATTR1,Ø:LOCATE38,16
26 ATTRØ,Ø:P$=INKEY$:IFP$=""THEN
26ELSEP=INSTR(1,"123",P$):CLS:IF
P=1THEN3ELSEIFP=2THEN27ELSEIFP=3
THENWIDTH32:ENDELSE26
27 FORT=1TO11:FORM=1TO11:A$(M)="
":B$(M)="":NEXTM:GOTO256
28 WIDTH32:PRINT@33,"YOU HAVE TH
E FOLLOWING OPTIONS":PRINT@64,ST

```

Run VIP on your Color Computer 1, 2 or 3!

VIP Calc

"MORE USEABLE FEATURES"-Feb 1985 "Rainbow"

Now every CoCo owner has access to a calculating and planning tool better than VisiCalc, containing all its features and commands and then some. *VIP Calc* displays 32, 51, 64 or 85 characters by 21 or 24 lines right on the screen. *VIP Calc* allows up to a 33K worksheet with up to 512 columns by 1024 rows! In addition, *VIP Calc* has multiple windows which allow you to compare and contrast results of changes. Other features include 16 DIGIT PRECISION • trig. functions • averaging • algebraic functions • column and row ascending or descending SORTS • locate formulas or titles in cells • block move and replicate • global or local column width • limitless programmable functions • works with any printer, Embed printer control codes for customized printing. Combine spreadsheet tables with *VIP Writer* documents to create ledgers, projections, statistical and financial budgets and reports. Requires 64K. TAPE \$49.95 DISK \$59.95

VIP Database

"ONE OF THE BEST" JULY 1984 "RAINBOW"

The *VIP Database* features selectable screen displays of 51, 64 or 85 characters by 24 lines for maximum utility. It will handle as many records as will fit on your disks and is structured in a simple and easy to understand menu system with full prompting for easy operation. Your data is stored in records of your own design. All files are fully indexed for speed and efficiency. Full sort of records is provided for easy listing of names, figures, addresses etc., in ascending or descending alphabetic or numerical order. Records can be searched for specific entries, using multiple search criteria. With *Database mail-merge* you may also combine files, sort and print mailing lists, print form letters, address envelopes - the list is endless. The built-in *MATH* package even performs arithmetic operations and updates other fields. *VIP Database* also has unlimited print format and report generation with embeddable control codes for use with all printers. DISK \$49.95

Coming Soon: VIP Database III

VIP Terminal

RATED BEST IN JANUARY 1984 "RAINBOW"

For your important communications needs you've got to go beyond software that only lets you chat. You need a smart terminal so that you can send and receive programs and messages and print them! The *VIP Terminal* features 32, 51, 64 or 85 characters by 21 or 24 lines on the screen and has a 43,000 byte buffer in a 64K computer to store information. Requires 32K TAPE \$29.95 DISK \$39.95

CoCo 3 owners upgrade your *VIP Calc*, *Database* or *Terminal* to run on the CoCo 3 for \$30 +\$3 S/H. Send original product.

VIP Disk-Zap

RAVED ABOUT IN THE APRIL 1983 "RAINBOW"

VIP Disk-Zap is the ultimate repair utility for simple and quick repair of most disk errors. Designed with the non-programmer in mind, the *VIP Disk-Zap* will let you retrieve all types of bashed files, BASIC and Machine Code programs. The 50 page tutorial makes the novice an expert. DISK \$24.95

SD Enterprises POB. 1233 Gresham, Or. 97030 (503) 663-2865
Please add \$3.00 for shipping. COD orders add an additional \$2.25. Personal checks allow 3 weeks for delivery. All other orders shipped the same day.

```
RING$(32,42);:PRINT@165,"1. PRIN  
T ANOTHER COPY":PRINT@229,"2. ST  
ART A NEW POSTER":PRINT@293,"3.  
QUIT"
```

```
29 P$=INKEY$:IFP$=""THEN29ELSEP=  
INSTR(1,"123",P$):CLS:IFP=1THEN9  
ELSEIFP=2THEN30ELSEIFP=3THENENDE  
LSEEND
```

```
30 FORM=1TO11:A$(M)="":B$(M)="":  
NEXTM:GOTO273
```

```
100 ' Graphics blocks data
```

```
101 DATA 252,239,239,239,254,224  
,236,239,239,239,254,224,239,224  
,224,224,239,224,253,239,239,239  
,251,224,224,224,224,253,239,224  
,239,251,224,224,224,224,239,239  
,239,239,239,224,234,233,224,224  
,239,224
```

```
102 DATA 239,239,239,224,224,224  
,239,224,224,239,239,224,224,224  
,224,224,224,224,224,224,239,224  
,224,224,238,239,239,239,251,224  
,239,224,224,224,224,224,224,224  
,224,224,239,224,254,224,224,224  
,239,224
```

```
103 DATA 234,239,239,239,239,224  
,239,224,224,252,239,224,239,224  
,252,251,224,224,239,252,251,224  
,224,224,239,239,254,224,224,224  
,239,224,253,254,224,224,239,224  
,224,253,254,224,239,254,224,252  
,239,224
```

```
104 DATA 239,253,239,251,239,224  
,239,224,239,224,239,224,239,254  
,224,224,239,224,239,253,254,224  
,239,224,239,224,253,254,239,224  
,239,224,224,253,239,224,239,239  
,239,239,251,224,224,224,224,224  
,253,254
```

```
105 DATA 253,239,239,239,239,224  
,253,239,239,239,254,224,253,254  
,224,252,251,224,224,253,239,251  
,224,224,239,254,239,252,239,224  
,224,252,239,254,224,224,252,251  
,224,253,254,224,224,224,224,252  
,251,224
```

```
106 DATA 224,224,252,251,224,224  
,224,252,251,224,224,224,252,251  
,224,224,224,224,252,239,239,239  
,239,224,239,239,239,239,254,224  
,224,224,252,239,239,224,224,239  
,239,239,224,224,224,239,239,224  
,224,224
```

```
107 DATA 252,251,253,254,224,224  
,239,252,239,239,254,224,239,251  
,224,224,239,224,239,251,239,224  
,239,224,239,232,232,232,232,224  
,231,231,231,231,239,224,252,239  
,239,254,239,224,239,224,224,239
```

```
,239,224
```

```
108 DATA 253,239,239,251,239,224  
,224,224,224,253,254,224,239,232  
,232,232,239,224,239,231,231,231  
,231,224,224,239,224,224,252,224  
,224,253,239,239,251,224,224,239  
,224,224,224,224,239,224,239,252  
,239,224
```

```
109 DATA 224,224,224,239,224,224  
,254,224,224,239,224,224,253,239  
,239,251,224,224,224,239,224,239  
,224,224,239,224,239,224,224,224  
,224,224,239,224,239,224,235,236  
,224,224,252,224,237,238,224,252  
,251,224
```

```
110 DATA 252,251,224,235,236,224  
,251,224,224,237,238,224,239,224  
,224,252,253,224,224,224,252,239  
,224,224,224,224,253,239,224,224  
,224,253,254,224,224,224,224,239  
,254,224,224,224,224,224,253,254  
,224,224
```

```
111 DATA 224,239,251,224,224,224  
,253,254,239,252,251,224,252,251  
,239,253,254,224,224,224,224,224  
,252,224,251,224,224,224,224,224  
,252,239,239,239,251,224,239,224  
,224,239,224,224,239,224,252,239  
,239,224
```

```
112 DATA 239,224,253,239,251,224  
,253,254,224,224,224,224,251,224  
,224,252,251,224,251,224,239,224  
,253,224,254,224,224,224,252,224  
,251,224,224,224,253,224,239,251  
,224,253,239,224,239,252,239,254  
,239,224,254,224,224,224,224,224  
,224,224,224,224,253,224
```

```
150 ' Characters data
```

```
151 DATA 12,12,12,12,12,11,12,11  
,11
```

```
152 DATA 68,68,68,11,11,11,11,11  
,11
```

```
153 DATA 68,68,7,68,7,68,68,11,1  
1
```

```
154 DATA 12,1,69,34,70,4,12,11,1  
1
```

```
155 DATA 11,71,72,41,42,73,74,11  
,11
```

```
156 DATA 38,68,36,38,39,75,67,11  
,11
```

```
157 DATA 63,43,11,11,11,11,11,11  
,11
```

```
158 DATA 76,42,63,63,63,78,77,11  
,11
```

```
159 DATA 79,80,65,65,65,41,81,11  
,11
```

```
160 DATA 11,11,11,82,36,38,83,11  
,11
```

```
161 DATA 11,11,12,12,7,12,12,11,
```

11
 162 DATA 11,11,11,11,11,11,63,43
 ,11
 163 DATA 11,11,11,11,7,11,11,11,
 11
 164 DATA 11,11,11,11,11,11,63,11
 ,11
 165 DATA 11,84,40,41,42,43,85,11
 ,11
 166 DATA 1,3,3,3,3,3,4,11,11
 167 DATA 48,12,12,12,12,12,47,11
 ,11
 168 DATA 1,15,15,86,14,14,7,11,1
 1
 169 DATA 1,15,15,17,15,15,4,11,1
 1
 170 DATA 87,87,87,33,65,65,65,11
 ,11
 171 DATA 7,14,14,34,15,15,4,11,1
 1
 172 DATA 1,14,14,45,3,3,4,11,11
 173 DATA 7,40,41,42,43,14,14,11,
 11
 174 DATA 1,3,3,7,3,3,4,11,11
 175 DATA 1,3,3,33,15,15,4,11,11
 176 DATA 11,11,11,12,11,11,12,11
 ,11
 177 DATA 11,11,11,12,11,11,12,42

,11
 178 DATA 40,41,42,63,78,80,58,11
 ,11
 179 DATA 11,11,11,7,11,11,7,11,1
 1
 180 DATA 78,80,58,15,40,41,42,11
 ,11
 181 DATA 1,3,91,41,12,11,12,11,1
 1
 182 DATA 1,3,88,26,89,90,36,11,1
 1
 183 DATA 1,3,3,7,3,3,3,11,11
 184 DATA 2,8,8,17,8,8,13,11,11
 185 DATA 1,3,14,14,14,3,4,11,11
 186 DATA 2,8,8,8,8,8,13,11,11
 187 DATA 1,3,14,9,14,3,4,11,11
 188 DATA 1,3,14,9,14,14,14,11,11
 189 DATA 1,3,14,14,10,3,4,11,11
 190 DATA 3,3,3,7,3,3,3,11,11
 191 DATA 47,12,12,12,12,12,47,11
 ,11
 192 DATA 5,15,15,15,16,3,4,11,11
 193 DATA 18,19,20,21,22,23,3,11,
 11
 194 DATA 6,14,14,14,14,3,4,11,11
 195 DATA 93,24,25,26,3,3,3,11,11
 196 DATA 3,27,28,29,30,3,3,11,11
 197 DATA 1,3,3,3,3,3,4,11,11

CocoTech

Presents...

ULTIMAX

NEW

Don't buy a high priced CoCo III interface that can only change between two CoCo III Max-type graphics programs!

With ULTIMAX you can switch between two popular CoCo III Max-type programs and also select the sensitivity of your joystick! You can use

ULTIMAX as a normal Hi-Res joystick interface or switch it to be used with a popular Max-type graphics program. The other feature of ULTIMAX is the Sensitivity Selector for added accuracy in your drawings! So why pay more for an interface with one option when with ULTIMAX you get two options for a cheaper price than our competitors!

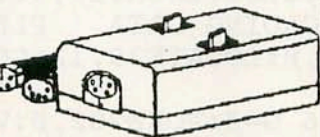

The ULTIMAX interface is only \$ 29.95

CocoTech
 208 Cathy Ann Drive
 Reading, PA 19606

Please make checks or money orders payable to: Thomas E. Keller

Shipping & Handling - USA and Canada add \$2.50
 - Other countries add \$5.00

PA residents add 6% Sales Tax

Sorry no credit cards or COD's Yet!

ARE YOU TIRED OF BEING TOLD THAT YOU NEED OS-9 TO RUN A HARD DISK

ON YOUR COLOR COMPUTER?

WELL, THE SEARCH IS OVER!
 ANNOUNCING THE BEST HARD DISK SYSTEM FOR THE COCO 1, 2 AND 3 THAT FULLY SUPPORTS DISK BASIC

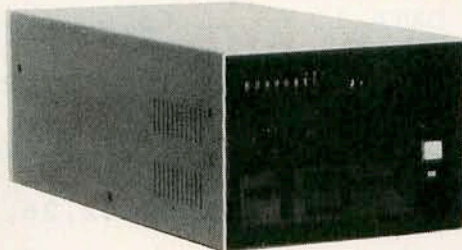

TOP QUALITY COMPONENTS, ALL GOLD CONTACTS, PROFESSIONAL SOFTWARE

STEP UP TO A LIGHTENING FAST HARD DISK - CALL NOW!

RGD COMPUTER SYSTEMS

294 STILLWELL AVE
 KENMORE, N.Y. 14217

(716) 876-7538

```

198 DATA 1,3,3,31,14,14,14,11,11 11
199 DATA 1,3,3,3,3,29,33,32,11 235 DATA 11,11,11,3,3,18,57,11,1
200 DATA 1,3,3,31,22,23,3,11,11 1
201 DATA 1,14,14,34,15,15,4,11,1 236 DATA 11,11,11,3,3,35,36,11,1
1 1
202 DATA 7,12,12,12,12,12,12,11, 237 DATA 11,11,11,26,26,64,57,11
11 ,11
203 DATA 3,3,3,3,3,3,4,11,11 238 DATA 11,11,11,35,36,38,39,11
204 DATA 3,3,3,3,3,35,36,11,11 ,11
205 DATA 3,3,3,26,96,95,94,11,11 239 DATA 11,11,11,3,3,18,57,15,6
206 DATA 3,35,36,12,38,39,3,11,1 2
207 DATA 93,35,36,12,12,12,12,11 240 DATA 11,11,11,31,41,42,44,11
,11 ,11
208 DATA 7,40,41,42,43,14,7,11,1 250 CLS3:PRINT@0," BULLETIN BOAR
1 D POSTER PRINTER":PRINT@32,STRIN
G$(32,42);:PRINT@102,"FOR COLOR
209 DATA 47,63,63,63,63,63,47,11 COMPUTERS";:PRINT@134," I - II
,11 - III ";:PRINT@166,"AND DMP-
210 DATA 11,97,90,78,80,58,98,11 130 PRINTER";:PRINT@229,"BY: GEO
,11 RGE QUELLHORST";
211 DATA 47,65,65,65,65,65,47,11 251 PRINT@288,"INDICATE WHICH CO
,11 MPUTER YOU HAVE":PRINT@325," PR
212 DATA 38,83,92,12,12,12,12,11 ESS <1> <2> <3> ":PRINT@384,"IF
,11 YOUR MACHINE DOES NOT OPERATE";
213 DATA 0,0,0,0,0,0,0,0,0 :PRINT@416,"WITH THE SPEED-UP PO
214 DATA 0,0,0,0,0,0,0,0,0 KE,(65495,0)":PRINT@455,"YOU MUS
215 DATA 11,11,11,58,55,56,57,11 T PRESS <1>"
,11 252 P$=INKEY$:IFP$=""THEN252ELSE
216 DATA 14,14,14,45,3,3,4,11,11 IFP$="1"THENCLS:GOTO253ELSEIFP$=
217 DATA 11,11,11,1,14,14,4,11,1 "2"THENCLS:GOTO254ELSEIFP$="3"TH
1 ENCLS:GOTO255ELSE252
218 DATA 15,15,15,44,3,3,4,11,11 253 PRINT@259,"LOADING DATA PLE
219 DATA 11,11,11,1,59,60,4,11,1 ASE WAIT":GOSUB279:GOTO273
1
220 DATA 46,12,12,47,12,12,12,11 254 POKE65495,0:PRINT@259,"LOADI
,11 NG DATA PLEASE WAIT":GOSUB279:G
221 DATA 11,11,11,1,3,3,33,15,4 OTO273
222 DATA 14,14,14,50,51,3,3,11,1 255 POKE65497,0:WIDTH40:PALETTER
1 GB:CLS1:LOCATE7,12:ATTR0,0:PRINT
223 DATA 11,12,11,48,12,12,47,11 "LOADING DATA PLEASE WAIT":ATT
,11 R1,0:LOCATE38,12:GOSUB279:GOTO25
224 DATA 11,65,11,65,65,65,65,66 6
,67 256 G=0:POKE282,0:WIDTH80:PALETT
225 DATA 14,14,18,19,9,22,23,11, ERGB:PALETTE1,0:CLS2:LOCATE11,0:
11 ATTR3,2:PRINT"SELF CENT
226 DATA 48,12,12,12,12,12,47,11 ERING POSTER PR
,11 I N T E R";:ATTR2,1:LOCATE78,0:
227 DATA 11,11,11,50,52,26,26,11 ATTR3,1
,11 257 FORF=2TO12STEP2:G=G+1:LOCATE
228 DATA 11,11,11,50,51,3,3,11,1 5,F:PRINTG;:H=G+6:IFH=12THEN258E
1 LSELOCATE40,F:PRINTH:NEXTF
229 DATA 11,11,11,1,3,3,4,11,11 258 LOCATE3,15:ATTR3,2:PRINT"
Input the amount of characters f
230 DATA 11,11,11,1,3,3,31,14,14 or line number one and press ENT
231 DATA 11,11,11,1,3,3,33,15,15 ER. ";:ATTR3,1
232 DATA 11,11,11,50,51,14,14,11 259 LOCATE3,16:ATTR3,2:PRINT"The
,11 following line lengths are avai
233 DATA 11,11,11,1,53,54,4,11,1 lable: < 8 > - < 13 > - < 16 > -
1 < 22 >";:ATTR3,1
234 DATA 63,63,63,9,63,61,62,11, 260 LOCATE3,17:ATTR3,2:PRINT"You

```

```

must stay within the [brackets
]. Press ENTER before the last b
racket." ;ATTR3,1
261 LOCATE8,19:ATTR3,3:PRINT"Pre
ss ENTER immediatly after the me
ssage to center your message." ;
ATTR3,1
262 LOCATE8,20:ATTR3,3:PRINT"
Press ENTER just before the last
bracket to left justify. " ;
ATTR3,1
263 LOCATE10,22:ATTR3,2:PRINT"EN
TER ANY LINE LENGTH AND PRESS EN
TER-ENTER FOR AN EMPTY LINE." ;A
TTR3,1
264 LOCATE10,23:ATTR3,2:PRINT"
ENTER ANY LINE LENGHT AND SHIFT
/UP - ENTER TO QUIT INPUT " ;A
TTR3,1
265 ATTR3,1:G=1:B=9:C=13:FORF=2T
O12STEP2:GOTO267
266 G=7:FORF=2TO12STEP2
267 LOCATEB,F:LINEINPUT"";B$(G):
IFG<6THENLOCATE40,F:IFG+6<12THEN
PRINTG+6
268 A=VAL(B$(G)):IFA<>8 ANDA<>13
ANDA<>16 ANDA<>22 THENLOCATEB,F
:PRINTSTRING$(25,32);:GOTO267
269 A=A+C:LOCATEA,F:PRINT"]";:LO
CATEB+2,F:PRINT"[ ";:LINEINPUT"";
A$(G):IFA$(G)=CHR$(95) THEN272ELS
ELOCATEA,F:PRINT"]":IFG+6<12THEN
LOCATE40,F:PRINTG+6
270 G=G+1:IFG=12THEN272ELSENEXTF
271 B=B+35:C=48:GOTO266
272 PALETTERGB:WIDTH40:CLS1:ATTR
0,0:POKE282,255:POKE65496,0:GOTO
3
273 CLS:POKE282,0:PRINT@1,"SELF
CENTERING POSTER PRINTER":PRINT@
32,STRING$(32,42);
274 S=96:FORF=1TO11:PRINT@S,F:S=
S+32:NEXTF:PRINT@481,"LINE WIDTH
S ARE: [8-13-16-22]";:S=100:FORF
=1TO11
275 PRINT@S,"";:LINEINPUT"";B$(F
):A=VAL(B$(F)):IFA<>8ANDA<>13AND
A<>16ANDA<>22THENPRINT@S,STRING$(
25,32):GOTO275ELSEPRINT@S+2,"["
276 A=(A+S+4):PRINT@A,"]";:PRINT
@S+3,"";:LINEINPUT"";A$(F):IFA$(
F)=CHR$(95) THEN278ELSEPRINT@A,"]
"
277 S=S+32:NEXTF
278 POKE282,255:POKE65494,0:CT=1
:GOTO9
279 FORX=1TO98:FORY=1TO6:READ A(
X,Y):NEXT:NEXT:FORX=1TO90:FORY=1
TO9:READL(X,Y):NEXT:NEXT:RETURN

```

```

300 'Printer codes gosubs
301 PRINT#-2,CHR$(27);CHR$(29);C
HR$(27);CHR$(14);:DP=INT((576-(L
C(D)*72))/2):RETURN' 8 Character
s double strike.
302 PRINT#-2,CHR$(27);CHR$(23);C
HR$(27);CHR$(14);:DP=INT((576-(L
C(D)*72))/2):RETURN' 8 Character
s single strike
303 PRINT#-2,CHR$(27);CHR$(18);:
DP=INT((480-(LC(D)*36))/2):RETUR
N' 13 Double st.
304 PRINT#-2,CHR$(27);CHR$(19);:
DP=INT((480-(LC(D)*36))/2):RETUR
N' 13 Single st.
305 PRINT#-2,CHR$(27);CHR$(29);:
DP=INT((576-(LC(D)*36))/2):IFDP>
255THENDQ=1:DP=DP-255:RETURNELSE
RETURN' 16 Double str.
306 PRINT#-2,CHR$(27);CHR$(23);:
DP=INT((576-(LC(D)*36))/2):IFDP>
255THENDQ=1:DP=DP-255:RETURNELSE
RETURN' 16 Single st.
307 PRINT#-2,CHR$(27);CHR$(23);C
HR$(27);CHR$(20);:DP=INT((960-(L
C(D)*42))/2):IFDP>255THENDQ=1:DP
=DP-255:RETURNELSERETURN

```



EZ WRITER

Leonardo's Pencil

For
Your
CoCo
1, 2, & 3

(Reviewed in Oct. 87 RAINBOW) Makes programming sensation-
looking graphics as easy as moving a joystick! Converts
precision drawings into "DRAW" commands which can be stand-
alone BASIC programs or merged into other programs. Also
includes "DEMO" and "PAINT" programs. Requires a spring-
centered joystick or touch-pad. 32k ECB tape or disk \$14.95

? ENIGMA?

Transform your computer into an ultra-secret code machine cap-
able of enciphering and deciphering in over 12 million virtually
unbreakable codes! (not simple substitution codes). Print hard
copy or store & retrieve coded data on tape or disk. Only the per-
son who has the password can read it! 32k ECB tape or disk \$12.95

New! EZ Writer

Just answer the prompts & type your message; "EZ WRITER" will
put it into perfect letter form and send it to your DMP or DWP.
Professional-quality, single-page letters every time! Do one letter
or multiple copies for "personalized" mailings. Saves letters and
mailing lists. Even does labels. Menu-driven. Undoubtedly the
EZ-est letter writing system available! Free sample on request!
32k ECB tape or disk \$19.95

EZ MATH PACKAGE

FOUR superior educational "games": "RACEWAY", "GO TO THE
TOP" (multiplication tables drill), "WORD PROBLEMS", & "PYRA-
MID". Covers addition, subtraction, multiplication, & division.
Different levels of difficulty. Exciting graphics & sounds. EZ and
fun! 32k ECB tape or disk \$19.95

KEYBOARD COMMANDER New!

Probably the most exciting typing tutor available for your CoCo.
You are the commander of a space ship & it's your job to shoot
down alien letters & words as they speed toward you & attack your
spaceship. Exciting Hi-Res action! 32k ECB tape or disk \$24.95

E.Z. FRIENDLY SOFTWARE

HUTTON & ORCHARD STS. • RHINECLIFF, NY 12574 • (914) 876-3935
(Add \$1.50 s/h to all orders. NY residents add state sales tax.)



Software

CoCo 3

Laser Surgeon: The Microscopic Mission — The Cutting Edge

"Cardiac arrest, doctor!"

"Bicarb! EPI! Defibrillate — 20 watt/seconds! Joystick!"

"Joystick?"

Absolutely! Pass the joystick, open your mind, and prepare to think, learn, and be entertained at a furious pace. As a cardiovascular physiologist, I always knew that medicine and anatomy were fun. There were a few problems, however, in convincing anyone else that this was, indeed, the case. With the programming wizardry of Mark Easter and Greg Zumwalt, and the medical expertise of Robert Clardy and Alan Zalta, M.D., *Microscopic Mission* should go

a long way toward changing this perception. The CoCo 3 is making a house call.

Bearing in mind that one is working within the limitations of a computer-simulated environment, *Microscopic Mission* proceeds with a startling aura of reality. Each player begins his "rotation" as a medical trainee sorely in need of polishing his or her medical skills. In view of this fact, the program assigns cases based on the recorded skill level of each player, a strategy that encourages inquisitive would-be doctors to continue to play, sharpening their skills even further. As these skills are dependent on real-life medical knowledge,

including anatomy, physiology, etiology (the study of the causes and origins of illness) and the treatment of human disease, the potential for learning is truly phenomenal.

The game begins with the assignment of a life-threatening case (patient) requiring successful microsurgical treatment within a specified period of time. Pertinent facts about the patient are displayed on a replica of a hospital chart. Details about the injury, lifestyle (smoker/non-smoker, alcohol use), allergies to medications and any other medical information vital to the case are contained on the patient's chart.

"Doctors" would be well-advised to follow the suggestions provided in the documentation and take adequate notes about their particular case before proceeding. Once the game starts, you cannot return to this screen and all its vital information until the patient either dies or is successfully treated.

Actual play begins with the injection of a microscopic probe into the patient's common iliac vein. All you old-timers out there may note that this Simulation is very similar to the movie *Fantastic Voyage* (sans Raquel Welch).

The probe is a well-equipped but rather fragile craft. Sensors detect and display the heart rate, blood pressure, and EKG of the patient on a continuous basis. A visual monitor is your view into this internal world, while other gauges and indicators display power status, laser condition, drug supplies, and other vital information.

Your task is a simple one: Pilot the craft through the venous system, through the right side of the heart, through the lungs (where you cross over to the arterial side of the circulatory system), back through the left side of the heart and up to the brain, where you finally perform your surgery!

Along the way you have to deal with invading bacteria, viruses, and the body's own immune system. The craft is a foreign body, and the patient's body will try to reject it, especially if he or she has been ill recently (remember to read the chart and take notes). Each of these attempts at rejection causes damage to the craft, which can result in partial loss of visual reception, loss of drugs stores, and damage either to the engines (reducing speed) or to the control system (reducing the craft's maneuverability). Eventually, encounters with these hostile forces will cause the outright destruction of the ship, the death of the patient, and the end of the game.

But medicine is based on knowledge and hope! And *Microscopic Mission* provides the player with both of these essential tools. There is an on-board library that can readily identify and explain the proper uses of the various tools, drugs, and instruments necessary to treat all the medical emergencies you will encounter. Whenever an invading microorganism is targeted within the laser sight, a press of the F1 key will prompt the ship's onboard library for more detailed information. Sequential screens detail the organism, describing where it originated, what diseases it can cause, and the proper treatment. The organisms are quite real, and the recommended treatments are medically accurate.

Points are awarded for correctly identifying an invading microorganism and dispensing the appropriate pre-

scription. However, the reverse is also true. Failure to correctly diagnose a disease (or to successfully treat a physical problem such as an irregular heart beat) results in the loss of points. Indeed, the first game I played resulted in an ego-shattering score of -2,000. Fortunately, the cumulative score log does not recognize values less than zero. Whew!



As the ship cruises through the various arteries and veins, the view constantly changes; erythrocytes (red blood cells) are numerous and constantly stream by the craft, as do the less numerous basophils, eosinophils, lymphocytes, etc. Even occasional immune globulins are seen! Throw in a spirochete or two, some *yersinia pestis* . . .

The anatomy lesson is equally impressive, replete with animated valvular leaflets in both ventricles of the heart. Also, atherosclerotic plaque abounds (hardening of the arteries). Incidentally, you can perform a real service for your patient by blasting those little grease spots with your laser (points never offend someone who once scored -2,000!).

By now you get the idea — the terminology is imposing. Those last paragraphs are but a sample of the treasures that have been planted within this program. I prefer to think of any learning experience in positive terms, but exposure to medical terminology may truly be a death sentence to some. If the terms that were thrown around so liberally a few sentences ago are a turn-off, I suspect that *Microscopic Mission* will be a disappointment for you. Be forewarned, and factor this into any purchase decision.

While we're on the subject of medical terminology and personal preferences, the matter of what age group would benefit from exposure to *Microscopic Mission* becomes quite important. While the terminology is certainly at the

high school level and beyond, there is at least one other consideration that many parents will want to know about. I've witnessed far too many people express offense when sexual information — no matter how it is displayed, or how important the message (consider AIDS) — is discussed. On your travels through the body, you will encounter noxious, sexually transmitted gremlins such as neisseria gonorrhoea and treponema palladium. The library accurately identifies these organisms as sexually transmitted, and offers advice on their treatment and avoidance. You have already been exposed to some of this terminology. A few paragraphs ago, the term *spirochete* was used. If you didn't recognize that clue . . .

Microscopic Mission breaks the mold in several other respects, not the least of which is the implementation of the CoCo 3 and OS-9 Level II. No toy business here, not at all! (Hello, Fort Worth, are you listening?)

This program was initially written for MS-DOS computers and ported over to the CoCo via OS-9 Level II. As I own an MS-DOS engine, as well as a 512K CoCo 3, I purchased both the MS-DOS and CoCo 3 versions of *Microscopic Mission* and ran them side by side. Both of these computers (and their operating systems) have their respective strengths and weaknesses.



MS-DOS machines are simply horrid at animation. Much of this is due to the fact that programmers insist on writing for the lowest common denominator in MS-DOS graphics, which is a standard called CGA (a resolution comparable to the CoCo 3 with an RGB monitor). But the MS-DOS machines have no provision for decent sound. Indeed, the cardiac arrest alarm in *Microscopic Mission* sounds like a mouse with a bad cold — hilarious, not alarming, and quite distracting.

Games are also speed-dependent, and

even with the processor set to 8 MHz, *Microscopic Mission* lagged terribly. Compared to the OS-9, Level II version, the MS-DOS version played in *slow*, disappointing motion. The documentation is the same for both versions, and aside from sound and speed differences, it was impossible to tell which version was which merely by looking at the monitors.

These variations highlight the subtle differences that go into a great program. While I would give the OS-9 version a 9.8 out of 10, the MS-DOS program would rate a "do not buy," in spite of the program's obvious merit.

A rating of 9.8 is hallowed ground, but some aspects of the program are a bit cumbersome. *Microscopic Mission* is active, at times too much so. I often found myself working the joystick (not required, but *highly* recommended), banging the < and > keys (to change direction), dispensing a drug (press D), and stopping the screen to prescribe a lifestyle change, *all at once*.

The CoCo 3 is an impressive machine, but it can handle only one input at a time. This leads to commands stacking up or getting lost, and the operator getting confused. Take it slow and easy until you become comfortable with the controls and their limitations. And one other tip — if you score in the negative range (or zero, as the cumulative scorekeeper sees it), just exit the game and restart the program. By doing this, a hard-fought skill rating can be saved from an instant demotion.

In addition to becoming familiar with medical terminology, the operator must also solve the anatomical riddle of the human circulatory system. Once is fun, twice is satisfying, but puzzling your way through it in every game can become a drag. Follow the tips in the manual and draw a map of the lungs. Once you have this in hand, you can sail through every time, and get on with the show. Everyone is allowed one oversight, and this needless, static repetition of the same maze is a major flaw, but one that can easily be overcome.

Microscopic Mission is supplied on a single floppy disk. The OS-9 Level II boot routine is on Side 1, as is the game initialization scheme. Follow the prompts, flip the disk over, and the game executes from the second (flip) side of the distribution disk. Interestingly, Side 1 may be backed up by the conventional BACKUP command, but Side 2 is apparently copy-protected.

Minimum system requirements are a 128K CoCo 3 (512K optional) and a

single disk drive. The use of an RGB monitor is a must, as the visual displays are extraordinary. The optional joystick is also a virtual requirement; there is simply too much keyboard *work* involved without it. The documentation is supplied as a bound 30-page manual, and is on par with the overall quality of the program (OS-9 version). A little perseverance, some luck and a steady hand are your keys to a memorable experience. The life you save may be your own.

(Activision, Inc., P.O. Box 7287, Mountain View, CA 94039, 415-960-0518; \$29.95. Available in Radio Shack stores nationwide.)

— Henry Holzgrefe

Software

CoCo 3

Data Master — Friendly OS-9 Filer

One of the major reasons given for the purchase of a computer is the organization of information. Usually, the new owner wants to organize a music or video tape collection, a stamp/coin collection, recipes, etc. There are specialized programs for such needs (some have appeared in THE RAINBOW), but there is nothing like a good generic database management system that can handle a variety of information applications.

Computerware's *Data Master* is such a program. Running on the CoCo 3 under OS-9 Level II, *Data Master* is a much friendlier version of two of its previous incarnations. Some years ago, Computerware published a program called *Data Bank*. Shortly after its publication, Tandy licensed the program from Computerware and renamed it *OS-9 Profile*. *Data Master* is fundamentally the same as *OS-9 Profile* in terms of overall capability, but is easier to use due to the windowing capability of OS-9 and the CoCo 3.

I have been using *OS-9 Profile* for a number of years and was pleased to see this update, although I still have some complaints. Fortunately, there is complete compatibility among the three programs. By the way, there is an upgrade option for those who have either *Profile* or *Data Bank* and want to obtain *DM*.

After copying *Data Master* into the

CMDS directory, you boot the program by typing *dm*. A startup file is provided but is not necessary if your system sets up a standard 80-column text window. Once *DM* has booted, the screen resembles a typical MS-DOS database screen. The top line of the screen is a menu bar from which pop-down menus appear at the press of certain keys. Within the menu bar are the following options: Desk, File, Work, Output, Edit, and Template. Access to these options from the menu bar are accomplished by typing the slash (/) key followed by 'D', 'F', 'W' or 'T'. The slash key always brings up the last selected pop-down menu. Selecting an item from the menu bar summons a dialog box, which acts as a submenu or requests further information of the user.

The menu bar provides access to all the major tools needed to set up and use a database. The Desk option provides the capability to change or view a directory, invoke a shell, set auto update, and change the printer path and monitor type. The File option takes care of opening, closing, renaming, deleting, and backing up files. In addition, there are options to save data in a *DynaCalc* spreadsheet format as well as load data from a spreadsheet. When starting a new database, you choose the Open option and tell *DM* the new filename.

After you have opened a new file, you must design the record structure, i.e., the number and type of fields that comprise a record. For example, I maintain a database of public domain software, a simple file containing the program's name, type, disk number, source, and a brief description.

Using the Edit option from the menu bar, you can add, modify, delete, and view the fields in the database as well as view the entire record structure.

When the record format is complete, the next step is to set up screen, access and report formats from the Templates menu. *DM* maintains up to nine screen, access and report formats that can be selected through the dialog boxes at any time. A use of the screen format may be to design various screens for data display. Designing these screens is very easy using the arrow keys to add descriptive information to the screen format. With the report formats, the user has control of the layout — margins, line width and lines per page — and can even send printer codes to the printer. The access formats allow you to sort the database up to three fields deep for each format. In my public domain program database, I have an index

sorted by disk number and program name, another by program type and disk number, and still another by just a program's name.

The Output menu allows you to examine all the records or a specific selection in the database using the current access method. Records can be displayed on the screen according to the current screen template, or they can be presented in spreadsheet style (one record per line). I like the spreadsheet option, as you can review a lot of data easily.

The documentation provided with *Data Master* consists of a 42-page manual, which gives a clear and concise description of all aspects of the program. The manual also contains an appendix that provides a tutorial using a file provided on disk. Another appendix gives technical information on *Data Master* files and on accessing them from BASIC09.

I have two problems with *Data Master*. The first is that field lengths cannot exceed 64 characters, and the second concerns report formatting. A maximum of five printed lines is allotted per record, which I find rather limiting. These two limitations probably won't affect most users in average use, but can

be problems for larger application. In any case, I do strongly recommend *Data Master* as a good generic database manager that is easy to use and provides a lot of capability. The frosting on the cake is that *Data Master* maintains downward compatibility with *OS-9 Profile* and *Data Bank*.

(Computerware, 4403 Manchester Ave., Suite 102, Box 668, Encinitas, CA 92024, 619-436-3512; \$64.95)

— Donald D. Dollberg

Software

CoCo 1, 2 & 3

Tomb of T'ien — Adventure in the Far East

Tomb of T'ien is a graphics Adventure game set in the far eastern part of Asia. As in many graphics Adventures, this one uses the split-screen feature displaying the current surroundings on the top half of the screen and the text description and action prompt on the bottom.

The scenario casts you as an adventurer trying to recover treasure that was stolen from your village. You must find the sacred shrine and conquer the evil dragon before he burns your village again. You experience many obstacles during this trek and will frequently call on the great Guru for advice.

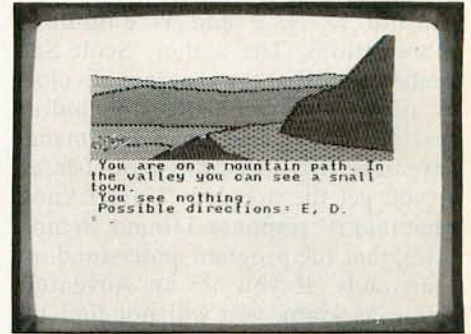

T'ien is written for a 64K Color Computer with Extended Color BASIC, but runs on the CoCo 3, as well. It is available on either disk or tape. If you have the CM-8 RGB monitor connected, you will get a black-and-white picture. If you use a TV set or color composite monitor, you will see the Adventure in full color. The program is copy-protected, but a procedure is

Clearbrook Software Group



Information Management System

CSG IMS is a full featured relational database manager for the Color Computer and OS9.

- Interactive access to databases for quick queries.
- User defined screen and report formats.
- Includes a structured compiled language
- Record, index, and file sizes are virtually unlimited.
- supporting program modules with full parameter passing and recursion.
- Text, BCD floating point (14 digits), short and long integer, and date data types.

CSG IMS for CoCo3 OS9-L2 512K (single user) \$169.95
 CSG IMS for OS9-L2 or 68000(multi user) \$495.00
 CSG IMS demo with manual \$30.00

OTHER CSG PRODUCTS:

ERINA Symbolic User-mode Debugger for OS9 \$69.00
 SERINA System-mode Debugger for OS9 Level 2 \$139.00
 MSF MS-DOS File Manager for CoCo3/OS9 L2 \$45.00
 MSF with SDISK3 \$65.00

Shipping — N. America: \$5, Overseas: \$10

Clearbrook Software Group, Inc.

U.S.: P.O. Box 8000-499, Sumas, WA 98295
 CANADA: P.O. Box 8000-499, Abbotsford, B.C. V2S 6H1

Phone: (604)853-9118

OS9 is a trademark of Microware Systems Corp.,
 MS-DOS is a trademark of Microsoft Corp.



PROGRAMS FOR PEOPLE

CoCo CHECKBOOK

More than a checkbook maintenance program. Handles budgeting, cash and teller machine transactions and automatic bank payments. Customizable with up to 64 expense accounts of your own choosing. Reconciles your checkbook with your bank statements; summarizes transactions by account, month or YTD, and permits searches on every field. Up to 1,500 transactions on a single disk system. An easy to use menu driven program \$25.00 plus \$2.50 shipping and handling. See review in December 1987, Rainbow Magazine.

CoCo ADDRESS BOOK

A mailing list manager, a personal phone book and an address book all in one program. The address book will store, sort, retrieve or print mail labels, either the whole file or one at a time, for friends, family or acquaintances. A year round help but especially helpful during holiday seasons. You can search the file on the last name, city, state/province, zip code, telephone area code or remarks. Up to 100 name/file and 78 files/disk. An easy to use menu driven program. A printer is recommended but not required. \$20.00 plus \$2.50 shipping and handling.

MASTER DISK VERSION 2.1

A computerized catalog of program names and disk names. Each entry in the catalog has the program name, extension and a 9 character disk name. To find that special program look it up in the alphabetized listing on the screen or a printout or have your Co Co search for it by name. Program names can be loaded by the disk full or entered 1 at a time. Up to 250 program names per file and up to 18 files per disk. An easy to use menu driven program. A printer is optional. \$15.00 plus \$2.50 shipping and handling. See review in January 1988 Rainbow Magazine

ALL PROGRAMS REQUIRE 32K CoCo 1,2 or 3 and 1 DISK DRIVE

SEND CHECK OR MONEY ORDER TO:
BOB'S SOFTWARE
 P.O. BOX 391 CLEVELAND, OHIO 44107

provided to a make a non-executable backup that can be used to restore the original if necessary. If trouble persists, the company will send you another copy free of charge.

The Adventure is challenging and incorporates many scenes and objects for you to GET, EXAMINE and DROP. Movement is accomplished using the familiar N, S, E and W command abbreviations. The author, Scott Settembre, says that the program has close to a 200-word vocabulary including over 100 nouns. That means commands have to be very specific in a lot of cases, or you get the dreaded "I don't know what that is" response. I found, in most cases, that the program understood my commands. If you are an Adventure junkie as I am, you will not find the commands unusual. Besides, an Adventure with a smaller vocabulary is very challenging to communicate with.

Tomb of T'ien is not a snap to solve. I spent many hours playing with it for this review and finally sneaked a peek at the solution the author provided before I was able to complete the Adventure. (Don't look for the solution if you purchase *T'ien*, because it's not part of the package.) Like anything challenging, you will do your best if you solve the Adventure a step at a time and keep a map of your progress. You can save your work on disk and pick up where you left off, so there's no need to try to solve it in one sitting.

Tomb of T'ien is an exciting Adventure with good graphics. I'd like to see a CoCo 3-specific version that could take advantage of the machine's enhanced graphics.

(Valkyrie Software, P.O. Box 2120, Monroe, NY 10950, 914-783-0191; \$19.95 plus \$2 S/H)

— Jerry Semones

Software

CoCo 1, 2 & 3

Lot-Pro — CoCo Helps You Pick Six

To win the lottery in my state, you must pick six numbers out of 40, and those six must match the numbers that the Lotto machine picks. In choosing these numbers, some people use their birthdays or social security numbers, or

they just play a hunch. Not very scientific. After looking into the situation, I wondered if my Color Computer could assist me in choosing winning Lotto numbers in a more logical manner.

Evidently Carl Nicita also thought computerized forecasting of lottery numbers has merit because he has released a program titled *Lot-Pro* to assist owners of Tandy Color Computers in becoming millionaires.

The principle of the program seems to be that although the "Magical Lottery Number Picker" is supposed to generate totally random numbers, there might be a repeating pattern that can be analyzed to determine what numbers will be most likely to appear in the future. Sounds logical enough, doesn't it? Let's take a closer look at the process.

First, you have to do some homework and get a list of numbers that have hit during the past 15 games for the lottery you want to analyze. You can get this list from your State Lotto Office.

Next, you enter the amount of numbers used in the lottery game, and the computer asks you a series of questions about how often this number has been a winner and the sequences in which these numbers have won. Your CoCo crunches this data and gives you a list of the hottest numbers down to the duds.

Lot-Pro gives you the option of using a wheeling system to add your favorite lucky number to these "hot numbers" to generate strings of six numbers.

By analyzing this printout and placing appropriate bets on these combinations, your odds of picking a winner can be greatly increased, or so the documentation implies.

Operation of *Lot-Pro* is easy. Screen prompts assist the user in the steps necessary to generate a printout. The program is also well-documented with a five-page instruction manual that describes how to operate the program, how it optimizes your chances of winning and how to analyze previous winning numbers to generate your data.

Does the program work? Well, the program runs, and it generates the series of numbers as promised. Does it produce winners? There was only one sure way to find out, by betting hard cash.

Here's how I did. Of the six numbers picked by the program, I hit two out of six. No bucks, but not bad. Realizing that a single bet would not prove or disprove the system, I also placed imaginary bets on the 41 other combinations that were generated by the wheeling system.

The results of these 41 bets were:

0 hits	13
1 hit	19
2 hits	6
3 hits	3
4 hits	0
5 hits	0
6 hits	0

	41 bets

These bets would have generated no winnings. Can you do better? I don't know. But you can easily find out by trying *Lot-Pro*.

(CJN Enterprises, P.O. Box 40487, Bakersfield, CA 93384, 805-836-1323; \$25.95)

— Bruce Rothermel

Software

CoCo 1, 2 & 3

The Astro Fortune Teller — Portents of Your Destiny

The Astro Fortune Teller is a machine language program written for the ECB Color Computer 1, 2 or 3. The author, R.J. Babich, Ph.D., is a sociologist and astrologer, and the program is based on his astrological principles.

If you run *The Astro Fortune Teller* on a CoCo 3 and the Tandy CM-8 RGB color monitor, the graphics title screen appears in black and white. This does not present a problem, however, as the title screen provides no useful function other than appearance (which is quite attractive). If this bothers you, you can always hook your CoCo 3 to a color TV set or use a composite color monitor.

The Astro Fortune Teller uses the standard 32-column screen to display questions and answers.

The program is supplied on a copy-protected disk, but the instruction sheet that comes with the software tells you how to make a non-executable backup copy to be used to restore the original disk if a problem arises. If the program develops a problem that cannot be fixed by a restoration, the company will send you another for \$3 to cover postage and handling.

The Astro Fortune Teller fills up an entire disk. In checking for the amount of free memory left on disk (`?FREE(0)`),

I got a response of 0 — this is due to the many data files (astrological tables) that comprise the various answers to your questions.

There are 30 pre-written questions to select from. After loading the program, you are asked for the day of your birth, your first name, and the current day of the week. You can then page through the various screens of questions to select the one you would like the fortune teller to answer. Such questions as "What day of the week or month will be the most important to me?"; "Is my absent friend happy or in trouble?"; and "In what calling or business will I prosper?" are typical. I would prefer asking my own questions, but I am sure such a program would be difficult to write given the memory constraints of the CoCo 1 and 2. Besides, the questions available pretty much cover the waterfront in terms of their scope. I must admit that I was surprised that many of the answers were very descriptive of some of my own situations and lifestyle.

I found *The Astro Fortune Teller* to be fun and interesting, and probably typical of the kinds of responses one would expect from a real fortune teller. It's not the kind of program that really fills a need in one's business or personal life, but can be used as an entertainment device. Who am I, though, to question the all-wise *Astro Fortune Teller*? Maybe if I heeded his advice I wouldn't have to work for a living!

(The Saint John Gallery, P.O. Box 613, Mt. Sinai, NY 11766, 516-928-6991; \$19.95 plus \$1.75 S/H)

— David Gerald

Software

CoCo 1, 2 & 3

Textform — Outputting Text in Two Columns

Have you ever needed to create a printout of a file in two columns? Or wanted to LIST BASIC programs in double-column format? I need to do things like that all the time. For one of my physics classes, I like to print a set of instructions that can be folded into a small booklet. Programming for two-column text output required a lot of time and creativity — until now.

Textform from R.A.D. Products takes the work out of formatting text in two columns. The input text can be

from any ASCII text file such as a BASIC program listing, word processor, or even a list. The author solves a programming problem in an elegant way.

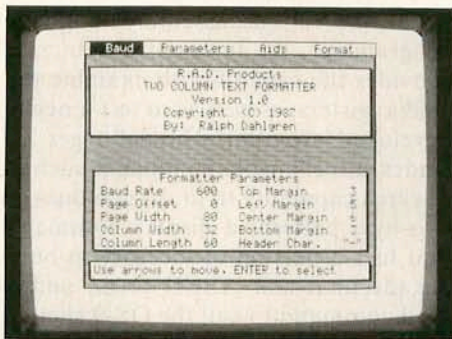

Textform comes on a single, unprotected disk and includes three files. TEXTFORM.BIN is the main program and does all the work. FONT.BIN is, I presume, a font file for the screen display. DEFAULT.PRF contains default settings for formatting text output. *Textform* is very easy to use even though it has many options and is quite flexible. The user interface is similar to the Apple Macintosh interface.

Input to the program is accomplished by an option bar and pull-down menus, which can be accessed via the arrow keys, joystick, mouse, Hi-Res input pack or digitizer pad. The program works just fine from the keyboard; the rest of the options are handy for those who prefer other input devices. Giving the user a choice is a professional touch I'd like to see in more programs.

Printer rates from 600 to 9600 baud can be set using the menu bar option Baud; specifying the file to print is done within Format. The two remaining menu bar options are Parameters and Aids. Parameters contains settings that affect the final look of the document. There are inputs for left, right, center, top and bottom margins; page and column widths; page offset; column length; and header characters.

Some of the options I found to be redundant. For example, I don't see the need to specify the column length if the top and bottom margins, header and page length have been specified. In fact, if all the settings don't agree, some pretty odd output is produced. This is only a minor inconvenience, however.

The author discusses how to choose parameters in the instruction manual and even gives equations for calculating them. Once preferences have been set within Parameters, they can be stored for future use. Different preference files can be created for different jobs. This way, when the output looks good, you

never have to remember how it was done. All you have to do is save the settings — another handy, professional feature.

The program also allows you to send printer codes directly to the printer. This is an essential feature if your printer requires special codes for different typefaces or type widths. This ability could have been coded into the program, but that would mean you would need a different version for each printer you use. I much prefer the manual approach; I've had a few oddball printers that refused to work with certain programs. That wouldn't be a problem with *Textform*.

Once the preferences are set, all that is left to do is select a file and answer a couple of questions. Then output begins. Before printing, word wrap can be turned on or off. Just after choosing the file to process, you are asked if you want to output to printer or a disk file. I wish more programs allowed this choice. With it, *Textform's* flexibility is multiplied manifold. With a word processor you can "massage" the output from *Textform* any way you like. This allows boldfacing, underlining, etc., in two-column format. I really have a lot of uses for this option.

If *Textform* stopped here it would be worth buying, but it doesn't. If you enter "slash" commands (command lines preceded by /) in your text, you can modify the output as the text is processed. The slash commands allow you to control header line text, page numbering, word wrap and forced page ejection. The manual clearly shows how all of these are done, providing several examples.

This wouldn't be a review if I didn't have a complaint or two. I already mentioned the "overlapping" parameter settings above. They are easy enough to work around that I don't find them a real problem. The only other complaint I have is also a small one: I can't find a way to get a directory listing from within *Textform*. If I remember to look at a directory and write down filenames before I start, that isn't a problem. Unfortunately, I never seem to remember to do that. I also seem to be good at forgetting the exact name of a text or parameter file just before I need it. It would be really handy to be able to look at a directory listing without exiting *Textform*. I can live with the problem — it's just a nuisance.

My recommendation is clear. If you do much text processing, you probably need *Textform*. If you do any two-

column text processing, you definitely need *Textform*.

(R.A.D. Products, 194 Hotchkiss St., Jamestown, NY 14701, 716-665-2124; \$34.95 plus \$3 S/H)

— Donald L. McGarry

Software

CoCo 3

OS-9 Development System — Completing the OS-9 Trilogy

When Tandy released the OS-9 Level II Operating System for the Color Computer 3, it soon became obvious that it was only a part — although a major part — of the full system. Careful review of the Tandy catalog revealed two additional packages: *Multi-View* and the *OS-9 Development System*. These three packages make up what I consider to be the complete OS-9 Operating System. Some users will run out and buy all three packages, while others will be content with the basic operating system. Although it is not possible to cover all the details of each item because of space limitations, I'll try to provide sufficient information so that you can determine your own needs.

First of all, the *Development System* is a package of programs for the advanced OS-9 user who programs in assembly language.

The *Development System* comes in a three-ring binder like the Level II package, with a "flippy" disk to accommodate all of the programs. These programs include an interactive debugger, screen editor, relocating macro assembler, several utilities to simplify assembly language programming, and 12 additional commands that were left out of the basic package but are familiar to all Level I users.

The interactive debugger is essentially the same as the Level I *Debug* command, so those familiar with the Level I version know what to expect. For the new user, a major function of *Debug* is to patch programs and other modules. For Level II, this can be accomplished using the *ModPatch* command, although *Debug* is more versatile because you can scan memory and look at specific memory addresses. *Debug* also contains a built-in calculator that

displays results in both hexadecimal and decimal. The calculator mode is intended for quick calculations pertinent to the development of an assembly language program.

For the serious assembly language programmer, the interactive debugger provides the capability to examine the 6809 registers, as well as to test a newly developed program. The debugger includes miscellaneous commands such as a search capability to look for a one- or two-byte pattern, a display command that lists a portion of memory in both hexadecimal and ASCII form, and a shell command to call the OS-9 shell.

The Level II screen editor, known as *ScRed*, is a screen-oriented text editor designed to prepare program text for the assembler or other high level languages. The major features of *ScRed* include adjustable screen and workspace size; cursor positioning by characters, words and line; cut and paste; change, find and search strings; and wild cards. While *ScRed* has most of the features of a good word processor and can be used for preparing typical text documents, it does not contain features such as word wrap and text formatting.

ScRed has three modes of operation — Command, Edit and Insert. Command mode provides the capability for manipulating files such as load and save. Edit mode provides for text modification in the edit buffer, and the Insert mode allows direct insertion of new text. *ScRed* comes with a file called *TermSet*, which allows for several different terminal types to use *ScRed*. Support is provided for both the VDG screen (the 32-by-16 CoCo screen) and the standard windows, as well as the terminal types KT7, ANSI, ABM85 and ABM85H. The manual provides enough information for writing additional terminal types for unsupported terminals.

The relocatable macro assembler, the heart of the *Development System*, is unlike the assembler (ASM) provided in the Level I system. RMA allows the programmer to assemble sections of assembly language code independently. The assembled sections are referred to as relocatable object files (ROF). With the linkage editor (RLINK), any number of ROF's can be combined into a single, executable OS-9 module. The features of RMA include built-in functions for calling OS-9 system routines; position-independent, re-entrant code support; creation of standard subroutine libraries, which can be written separately and then linked together; conditional as-

sembly and library source file support; and OS-9 modular, multitasking environment support.

RMA is a two-pass assembler. In the first pass through the source code, RMA creates the symbol table. During the second pass, RMA adds the machine language instructions and data into the relocatable object file.

Included with RMA is the all-important DEFS directory. Files included in this directory contain definitions of symbolic names for all system calls. The file *OS9Defs.a* provides definitions for all system functions under Level II. For programmers who might prefer to use the Level I ASM assembler, the DEFS directory contains the files *DefsFile*, *DefsFile.dd*, *OS9Defs* and *SysType*. These files contain Level II information in the correct format for ASM. Also included in DEFS are the files *Wind.h*, *Mouse.h* and *BufFs.h*, which contain data structures for window, menu, mouse and buffer manipulation using the C language. Still another file, *CgFx.l*, provides Level II graphics routines for the C language.

Space does not permit an in-depth discussion of RMA and RLINK, but I would like to mention that RMA is not just for the advanced assembly language programmer. As everyone is aware, there are some very interesting utility programs published in THE RAINBOW and available on bulletin boards. Without RMA and the DEFS files, it would be impossible to obtain an executable module. This may be reason enough to consider the purchase of the *Development System*.

The modular concept of OS-9 makes program development much simpler, especially with tools like RMA. However, keeping track of the various modules and ensuring that you are working with the most current versions becomes somewhat difficult. Enter the *Make* and *Touch* utilities, which are standard UNIX tools used during program development to make sure all modules are up-to-date. *Make* also simplifies the process of recompiling the entire program when one module is updated.

Also included in the *Development System* is a virtual disk driver, commonly known as a RAM disk. A RAM disk is simply a part of memory formatted to operate as a standard disk drive, but at a much faster speed. RAM disks are useful when dealing with very disk-intensive operations, such as assembling or compiling programs, or for editing large text files. I find it partic-

ularly useful when downloading from bulletin boards.

To use the RAM disk, all you have to do is load the driver RAM and an appropriate r0 descriptor. The disk comes with three versions of r0: a 96K version, 128K version and a 192K version. The manual provides information on how to change the r0 descriptor for other memory sizes. Once RAM and r0 are loaded, all that is needed is to initialize r0, and the RAM disk is ready to go.

When the original Level II package was released, many people were disappointed that a number of Level I commands were not included. However, all of the missing commands are included in the *Development System*. The commands are Binex, Dump, Exbin, Login, Park, Save, TSmom, Tee and Verify.

Although most of these commands are not often used, I have had need for the Save, Dump and Verify commands and would have liked to have seen them included in the basic Level II package.

The *OS-9 Development System* is certainly a must for all assembly language programmers. Other users should weigh the cost versus the need for this capability. Overall, Tandy has provided

an excellent package for program development with all the supporting tools needed for this endeavor.

(Tandy Corporation; \$99.95. Available in Radio Shack stores nationwide.)

— Donald D. Dollberg

Software

CoCo 3

Telewriter-128 — 80 Columns, Lightning Speed and New Power Enhance the "Old Standard"

In my opinion, the one program that has made the Color Computer the popular small computer that it is today is *Telewriter-64* from Cognitec. *TW-64* introduced thousands of us to the world of word processing and enabled us to use these inexpensive computers in new and imaginative ways.

Now Cognitec, in conjunction with

Bob van der Poel, has released *Telewriter-128* for the CoCo 3. They have incorporated the best features of *Telewriter-64*, *Telepatch* and *Ultra-Telepatch* into this exciting version, while adding many new features and refinements.

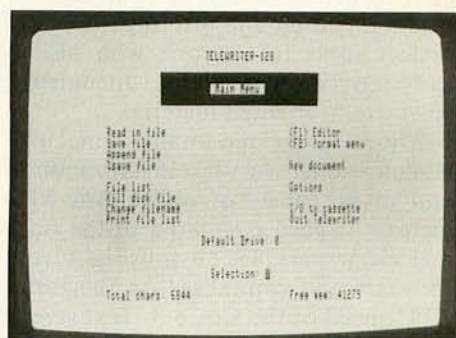

The program is not copy-protected, so making backup copies for your own use is not a problem. The *Telewriter-128* disk contains the *TW-128* program, two short demo text files, and a conversion program, which lets you convert older *TW-64* BIN files to work on *TW-128*. Cognitec has discontinued the use of binary file storage in lieu of the universally accepted ASCII file saves.

For those of you not familiar with the

Check Account Information System

If you have one or more checking accounts then you need **CAIS**. This is not just another checkbook program but an easy to use, menu driven, disk based information system for the CoCo 1, 2, 3.

Record all account activity. Keep track of your expenses using the 36 categories that you define. Set up automatic transactions for such items as direct deposits and deductions. Reconcile and balance your account(s) in minutes! Other features include check search on any field, edit and delete capability, display and print options, multi-drive capability and more. Requires 1 drive, printer optional.

Reviewed in RAINBOW, February 1988.

After Five Software
P.O. Box 210975
Columbia, SC 29221-0975
(803) 788-5995



To order send check or M.O. for \$34.95 plus \$3.00 S/H. COD orders add \$1.00. (SC residents please add 5% sales tax)

THE SOFTWARE HOUSE

CELEBRATING OUR 4TH YEAR WITH RAINBOW!

DS/DD DISKS  \$45/100
10/\$4.95

FLIPPY DISKS 10/\$7.95
FACTORY PUNCHED—USE BOTH SIDES. \$75/100
CERTIFIED ERROR FREE. W/SLEEVES, LABELS, W.P.

3 1/2" DISKS DS/DD 10/\$14.95

PRINTER RIBBONS

EPSON MX/RX/FX 70/80	\$5.00 EA.	6/\$28.00
GEMINI 10/10X/96	\$2.00 EA.	12/\$22.00
COLORS R-BR-BL-GR-PUR	\$3.00 EA.	5/\$12.00
R.S. DMP 130 BLACK	\$6.95 EA.	
COLORS RED-BLUE-GRN	\$7.95 EA.	

OTHER RIBBONS IN STOCK—CALL OR WRITE FOR QUOTE

ALL ITEMS 100% GUARANTEED. OFFER ENDS IN 30 DAYS

Add \$2.50 S/H in U.S.A. - Canada Add \$3.50 + \$1.00/LB
Michigan Residents Add 4% Sales Tax
Send Check/Money Order Payable to:

THE SOFTWARE HOUSE

9020 Hemingway, Redford, MI 48239
(313) 937-1313



Send Card Number & Exp. Date

Min. Charge Order \$20.00

term, *word processing* allows you to write and edit text on the screen of your computer monitor and print hard copies on your printer. You can then save the text to tape or disk for later recall or editing. Word processors are, in effect, electronic typewriters that can be used to compose any kind of text for reading, editing and printing. They are perfect tools for anyone who has to write letters, create forms, documents, or any text-oriented material.

TW-128 is written totally in machine language and is very fast in its execution and in all facets of operation. This increased speed compared to the original *Teletwriter-64* is obvious right from the start and capitalizes on the faster CPU speed of the CoCo 3. Text scrolls faster, keyboard input is clearer, and I could find no evidence of keyboard

delay or screen updating. *TW-64* used its own software-generated character set, while *Teletwriter-128* accesses the CoCo 3's video circuitry directly. The result is an outstanding 80-column display on a monochrome or RGB monitor.

Getting Started

After executing the program, you are greeted with a colorful credit screen and then automatically switched to the main menu. Two of the options on this screen are Read, which allows you to load in a file from either disk or tape, and Save, for saving a file to disk or tape.

In the *TW-128* disk version, the Read command first displays the names of all ASCII text files on the default drive. You select which file you want to read in by using the arrow keys to move the

highlighted cursor to the file of your choice and pressing ENTER.

If you are using cassette, a window is displayed that requests the filename of the file to read in. Cognitec provided a nice touch in allowing disk users to save their text files to disk without having to go to a separate Disk I/O menu. Just pressing CTRL-Q at any time while in the editor or text mode performs a "quick save." Provisions are also included to automatically make a backup of your text file every time you save it to disk.

Main Menu and Editor

From the main menu, you can at any time go directly to the Editor screen by pressing the F1 function key. Similarly, you can go to the Format menu by pressing F2. This makes it very easy to jump back and forth between your text and either of the two menus.

You can select either the insert or overstrike mode by using CTRL-O to toggle between the two. CTRL-M now performs a true block move within the editor — you don't have to go back to the main menu. CTRL-Y does a word delete or "yank," and a "non-breakable space" can be created using the ALT key and the space bar.

Word wrap occurs at the current value of "characters per line," and not only at the edge of the screen, as in *TW-64*. (When the number of characters in a line of text approaches the value you have set for the number of characters per line allowed, the cursor automatically begins a new line. Word wrap can be toggled on or off depending on your preference. You can set characters per line in the Format menu as well as in Editor mode by pressing CTRL-@.

While the Read in File option displays only text files saved in ASCII form, the File List command lets you display *all* files on the disk and also returns the number of free granules remaining on the disk.

From the main menu you can also kill a file, change a filename, or print a file list. "Print File List" lets you send a list of the selected disk contents to your printer. This is a handy way to keep a hard copy of all your word processing files as you save them to disk, and it can even be used to catalog your disks.

Total characters used and the amount of remaining free memory are displayed at the bottom of the main menu screen. On my computer, the free memory amount was 48,123. This represents roughly enough space to accommodate 24 pages of text. As text is typed in, this number will decrease accordingly. On

star MICRONICS MULTI-FONT PRINTER NX-1000 NEW

The NX-1000 gives you plenty of print options for attractive printing. Four typestyles. Four pitch sizes, in standard and italics for a total of 32 NLQ modes. The NX-1000 Rainbow gives you all these features plus online access to 7 color printing and graphics. Black, blue, red, yellow, green, violet, and orange. Both models have a 1 year warranty, nationwide service and a 30 day online trial.

NX-1000 SPECS: 144 cps Draft, 36 cps NLQ (18 x 23 dot matrix), 4 NLQ Fonts, Italics, Sub & Superscripts, Emphasized, Doublestrike, Proportional, Condensed, International, Downloadable, Quad Tall, Double Tall, Underline, 9+ Pitches, Forward and Reverse n/216° Line Feeds, Absolute or Relative Vert. & Horz. Tabs, Left, Center or Right Justification, 8 Graphics Modes to 1920 dpi, Macro Instruction, Bidirection, Adjustable Tractor Feed, 200+ Printable Characters, Semi Auto Sheet Feed, Front Panel Soft Touch Control, Epson and IBM Emulate, 4K Data Buffer, Hex Dump.
Rainbow: Same plus color.



NX-1000 SYSTEM INCLUDES:

- Star NX-1000 Printer
- Blue Streak Ultima
- Software Support Trio

\$199⁹⁵
+ \$10 Shipping and Insurance
COMPLETE

NX-1000 RAINBOW SYSTEM INCLUDES:

- Star NX-1000 Colour Printer
- Blue Streak Ultima
- Software Trio
- Color Imaging Software

\$299⁹⁵
+ \$10 Shipping and Insurance
COMPLETE

Software Support Trio

TYPE SELECTION/TUTORIAL

Online instructional program that will select 24 special features of your printer or display methods to incorporate them into your programs.

SUPER GEMPRINT

Will transfer a Pmode 0, 1, 2, 3, or 4 picture screen to printer 8"x11" hardcopy. Black/white, white/black or grey level shading for color.

HI-RES SUPER GEMPRINT

Disk software that will transfer a Hscreen 1,2,3 or 4 picture screen to printer. Grey level shading for color.

Software Trio
\$19⁹⁵

Price, availability and specifications subject to change without notice.

DAYTON ASSOCIATES of W.R. HALL, INC.

7201 CLAIRCREST, BLDG. D
DAYTON, OHIO 45424

OHIO RESIDENTS ADD 6% SALES TAX • C.O.D. ADD \$2.00

PERSONAL SERVICE

(513) 236-1454

Visa & MasterCard
within the continental U.S.

the other hand, the total characters number will increase as text is typed in.

The program defaults to Drive 0 but can be changed simply by pressing 1, 2 or 3 while in the main menu mode. Disk I/O is lightning fast, as the I/O programming is contained in memory. There is no wait when you want to access your disk. You're there instantly.

Options

The Options command on the main menu allows you to configure *Telewriter-128* to suit your personal preferences. The Options menu lets you select character color (63 choices) and background color (also 63 choices). The color changes occur live — that is, as you increase or decrease the values with the arrow keys, the screen and character colors change before your eyes. You can see instantly the color combination that best suits you. I like white letters on a royal blue background, but the choices are seemingly endless.

Another option lets you turn the color off if you are using a monochrome monitor or a black-and-white TV. You can also set the number of displayed lines on the screen to 24, 25 or 28. The text display on my CM-8 RGB monitor was great, and on the Magnavox 8915 it looked even better. If you plan on using a TV set, you may have to use the program in the 40-column mode due to lower resolution. You can toggle between 40- and 80-column modes with SHIFT-0.

Commands are also provided on the Options menu to set key repeat and delay rates and key click pitch. You can turn the key click on or off using CTRL-L. I like hearing the key clicks — they give me positive indication that a key has, indeed, been pressed. Whatever options you select can be saved to disk or tape so that you won't have to re-enter them each time you boot the program.

Format and Print

The Format and Print menu screen is accessed by pressing F2 at the main menu. This is where you select line spacing, margin settings and lines per page. As in *TW-64*, you can number the pages and select where across the bottom of the page to put the page number.

"VPrint" is a major addition that allows you to preview your document on the screen so that you can see how the document will look before you actually print it. It shows the margins, page breaks and page numbers just as they will appear on paper. Holding

down a SHIFT key during preview slows down the scrolling speed of the document — you can change this speed in the Options menu if you want. This preview feature is a real bonus and will save a lot of printer paper and frustration.

Another new feature much to my liking is the #Print command, which allows you print out any number of copies of your document.

The *Print command is provided so that you can send a fully formatted file, complete with embedded control codes, margins and spacing, to disk. This kind of file is generally useful with a communications program when you want to ensure that the total file is sent intact.

As in *Telewriter-64*, you are able to print portions of a document. CTRL-E is used to mark the end of the portion of text that you want to print. Pressing the

% key within the Format menu sends the marked portion to your printer. Also as in *TW-64*, you can right-justify your text. Note that the result of right-justification does not show up on the Editor screen, but it will show up on the VPrint screen and on the printed page, as well. *Telewriter-128* supports all baud rates and is adjustable from 110 to 9600 baud using the XMIT Rate command.

Other New Features

New to *TW-128* are 26 individual macros that can be used to store often-used text of up to 127 characters. A nice feature here is that you can also store embedded control code sequences. Anything you set up in these macros will automatically be saved to disk when you select Save on the Options screen.

The Ultimate Serial to Parallel Converter!

7 Switchable Baud Rates

Use this "smart" cable to connect a Centronics parallel printer to any version CoCo or use it to improve performance of your current printer.

Try it on your system for 30 days RISK FREE. One year warranty. Dealer inquiries on quantity 3+.



\$39⁹⁵
+\$2 Shipping

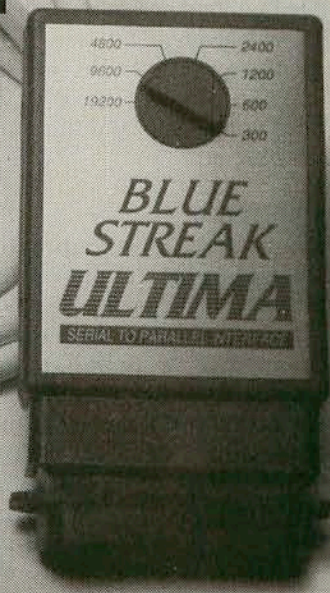

Print in Color on your Star NX-10 or DMP-130

Color Imaging System

Super Gemprint Color Imaging System

Use your favorite program to create a pmode or hi-res graphic image, but don't stop there! Run our color graphics software and print a color image using a palette of 81+ colors on your NX-10 or DMP-130 from a CoCo 1, 2, or 3. This system superimposes 4 graphic screen dumps (black, blue, yellow & red) while prompting you to change ribbon cartridges after each page. The colors mix and add to give you your own color masterpiece.

Includes: Color Super Gemprint, Hi-Res Color Super Gemprint, Plus 1 blue, 1 red & 1 yellow ribbon cartridges.

System Requirements: 32k ECB Disk, Blue Streak 1, 2, 3 or Ultima

Price, specifications subject to change without notice.

\$39⁹⁵
+\$3 Shipping

DAYTON ASSOCIATES of W.R. HALL, INC.
7201 CLAIREST, BLDG. D
DAYTON, OHIO 45424
OHIO RESIDENTS ADD 6% SALES TAX • C.O.D. ADD \$2.00

PERSONAL SERVICE
(513) 236-1454
Visa & MasterCard
within the continental U.S.

This is nice because you can set up your printer for different fonts, print sizes, etc. Recalling a macro is as simple as pressing ALT and A through Z. In a typical application, one might have the words *University of Louisville* stored in Macro U. Let's say that I am preparing several letters to an alumni association. Instead of having to type *University of Louisville* many times, I can simply press ALT-U, and the words are automatically inserted in the text.

Pressing a CTRL-F while in the Editor results in a pop-up window where you enter the string of letters that you want to find in your document. A command in the Options menu can be set to ignore case. This means that words such as WORLD, World, or even wOrLd, could be found and displayed from just one reference. If you prefer, you can turn the case sense off so that the matching text must exactly match the search string.

TW-128 supports header and footer commands, as well as alignment protection for columns and many other embedded commands, including embedded control codes.

There is even a Help screen available by pressing CTRL-H. This is very useful in that you won't have to look up various commands and functions in the user's manual.

In Conclusion

Telewriter-128 is impressive. The extensive use of "dialogue" boxes or windows provides a more foolproof way to communicate with the program and results in very clean, efficient and smooth operation. It matches in many ways the capabilities of word processors used on IBM and compatible computers. *TW-128* has virtually all the features required of an excellent word processor except a spelling checker — although it should work with any ASCII-based spelling checker. Maybe the authors will give some thought to that need, especially considering that our CoCo now has a memory capacity of 512K!

Telewriter-128 will set the word processing standard for the Color Computer 3 because it is so simple and user-friendly; the price is about right for a program with the capabilities it provides.

The 81-page tutorial/user's manual is nicely done. It is written in easy-to-understand language, but the program itself is so easy as to make the documentation almost unnecessary. Most people will be able to use the software right out of the package.

About the only problem I could find with *Telewriter-128* is that it took such a long time to arrive in the CoCo 3 marketplace. I am confident, however, that, like good wine, it was worth the wait.

(Cognitech, 704 Nob Ave., Del Mar, CA 92014, 619-755-1258; \$79.95 disk, \$69.95 tape plus \$2 S/H)

— Jerry Semones

Software

CoCo 1, 2 & 3

REMUSIC 1.0 — Music to Your Ears

Anyone who has done any BASIC programming knows that there are two schools of thought concerning the use of REM statements. One advocates the frequent use of them to make detailed comments in the program listing so that you can pick up the program later and quickly tell what each line of code is doing.

The second school of thought advocates the concept that REM statements are a waste, eating up valuable memory and processing speed, and that it would be better to delete all REM statements and use the extra memory for better things. In fact, in the early days of personal computing, especially when memory was at the 4K level, there were a number of public domain programs around whose only function was to strip REM statements from a BASIC program.

Well, *REMUSIC* author, William C. Garretson, has just added a third school of thought on the use of REM statements: Make music with them!

REMUSIC 1.0 works on any Color Computer having at least 16K of memory and one disk drive. On the CoCo 3, it will work in the high-speed mode and makes for more pleasant sound reproduction.

The program is both a music compiler and a software music synthesizer supporting over six octaves of four-part music with complete tone and ADSR control. (For those of you who don't know what ADSR means, it stands for "Attack, Decay, Sustain and Release.")

OK, now everybody knows what ADSR is and can fully explain it, right? — *wrong!* One of the best things about *REMUSIC* is its documentation, which goes into great detail to explain not only how to operate the program but also just what all these "synthesized" music

terms are, as well. It explains them in terms of how they affect our hearing and how the individual notes and sounds are created. (The author also included a glossary of such terms for quick reference.)

An added bonus to the accompanying documentation and tutorial (which because of its depth and detail could become somewhat trying) is the author's liberal use of witty and sometimes biting comments. Even if the program didn't work well at all, the documentation would be well worth reading.

In *REMUSIC*, Mr. Garretson has created a powerful music text language, incorporating it in such a fashion that the regular BASIC language of the CoCo provides the editor for it.

There are several ways to use the program. The simplest is to create what looks like a BASIC program in which each line is a REM statement. Each REM statement may contain information regarding the playing of one or more voices, and the duration and pitch of a note or rest. If the compiler encounters an invalid music directive in a REM statement, it skips to the next character. Placing other comment lines in the file may have a considerable effect on the compiled music.

Music code can also be embedded in a regular BASIC program with a few lines included at the beginning of the program to call *REMUSIC*. This feature can be used to create interesting graphic/music displays. The third way in which *REMUSIC* can be used is in the creation of stand-alone machine language music files. After a piece of music is written and compiled, it can be saved as a binary file.

Mr. Garretson seems to have put a lot of work into this program and has overcome many of the deficiencies I have noticed in other music compiler programs. For example, the author provides a way to program each voice separately without having to be concerned with what note duration the other voice is using; and he has provided his program with a respectable octave range. Some music programs have a limited range, which makes things difficult when you're trying to transpose a piece of sheet music to the computer. Others boast of a large range, yet tend to distort at the higher pitches. *REMUSIC* can play frequencies as high as the third A above middle C without excessive frequency distortion. In order to really appreciate this you need to pipe the sound output through a speaker of better quality.

As mentioned earlier, CoCo 3 owners can use the high-speed mode to further extend the pitch range and to enjoy better quality sound. However, this will also cause the music to play twice as fast. To overcome this problem, the author has included a utility to compensate.

If you are like me, the first thing you want to do with a music program is listen to just how good it really sounds. After all, isn't that the real test of any computer music program? What I don't want to do is sit down and key in a lot of code for just a simple demonstration. The author anticipated people like me, for he thoughtfully provided several selections of music already keyed in and ready to play. Very impressive, let me assure you.

This program rates very high on my recommended "must have" list.

(Codis Enterprises, 2301-C Central Drive, Suite 684, Bedford, TX 76021, 817-283-8571; \$25)

— Kerry Armstrong

Software

CoCo 3

The Rat — A Mouse-Assisted CoCo 3 Graphics Package

Into the competitive arena of CoCo 3 graphics programs comes a powerful new challenger — *The Rat*. It was worth the wait. One of the most impressive features of the package is the mouse, which is much better than Tandy's CoCo mouse. In fact, there are very few things about the package that I did not like. (Contrary to the illustration of the mouse in Diecom's ad in THE RAINBOW, the mouse requires no adapter, and simply plugs into your right joystick port.)

While the program works very well on a 128K machine, you will not be able to access all its features until you have a full 512K. *The Rat* supports the 320-by-200 Hi-Res graphics mode, lets you work with 16 fantastic colors at a time, and even allows you to load and edit a

picture created with *Color Max 2* or *Color Max 3*.

Upon booting *The Rat*, it does not take long before you are drawing your first picture. In fact, *The Rat's* extreme ease of use may prove to be a disadvantage — family and friends might be tempted to commandeer the machine and program for themselves (it just about lost me my CoCo 3 to my sons).

I really would like to have seen some "professional" quality pictures, but there are no sample pictures accompanying the package. There is a very good picture of a rat, though, that pops onscreen while the program is loading, but you can't load it in to work with it. However, it wasn't too long before we had pictures of our own. As I said before, the program is very easy to use — and it's good that it is, because the 22-page manual is not the most comprehensive I have ever seen.

Commands are issued from the four pull-down menus that run across the top. Just point and click. The rest of the screen gives you the options of colors, type of "brush," the use of 16 textures, mode boxes (draw, line, circle, etc.), and a "fill" option to be used with box, circle and polygon modes.

BOWLING LEAGUE SECRETARY (C)

For Co-Co 1,2 or 3 with disc drive, printer, 32K RAM.



Reviewed:
Sept 1986 April 1987
Page 141 Page 140

- User friendly--full menu driven selections.
- Any number of teams or bowlers.
- Calculates and stores all team and bowler stats.
- Men, women, mixed, scratch or handicap; blinds and substitutes.
- Start up any time in season.
- Full edit capability.
- Automatic backups and weekly, mid-season and end-season resets.
- ABC/WIBC style printouts.
- Modular programs all in BASIC, easily customized.
- Instruction manual includes sample printouts of stat sheets, special summaries for paper backup.
- Free Upgrade for Individual Tally Sheets.

Priced at \$49.95 including S&H and Sales Tax.
To order, send check or M.O. and specify Version number:
(1.0 for men or women; 1.1 for mixed)
and number of disc drives.

TOMELA*CO

P.O. BOX 2162
DOYLESTOWN, PA. 18901-2162

2584

IS THE YEAR

THE LARGEST AND MOST TERRIBLE WAR WAS JUST BEGINNING TO DAWN, THIS IS THE TALE OF THE SKIRUM WAR AND THE....

KILLER KIFER

AS REVIEWED
IN 2/88
RAINBOW

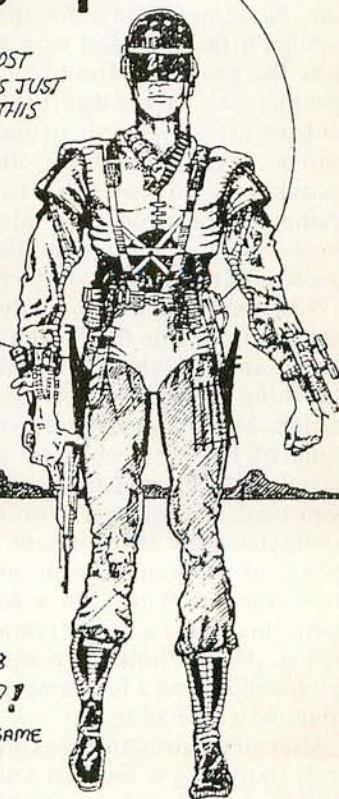

TO ORDER:
SEND CHECK OR MONEY
ORDER FOR \$25 TO:

HEROIC DESTINIES
54 OAK ST.
NORTHPORT, N.Y. 11768

RAINBOW CERTIFIED!

32 K ACTION/ADVENTURE GAME
FOR THE COLOR COMPUTER
1, 2, 3.
C.O.D.'s ADD \$2.00
N.Y. RES ADD 7.5% SALES TAX.

From the menu, if you have 512K, you can pick which of 10 screens you want to work with. With 128K, you can have only one screen in memory, but with 512K, you can work with up to 10 at the same time. This also allows you to use the "pages" feature. This feature allows screen animation in which the program flips through your screens with an order and speed you determine. If you do not have 512K, you still have the option of "color animation," which allows you to change the colors in a certain order and speed. By itself this feature can produce some interesting results.

Another strong point is *The Rat's* versatility. If you want a different set of 16 colors, you can select them, just as you can select and save 16 new textures for later reloading. You can even define your own character set or just edit the default set. Even the brush shapes are redefinable. The options available are just too numerous to list. And, again, I have to say that the mouse included with the package is just great! I was so accustomed to the mouse I use with my Tandy 1000 that I guess I got spoiled — I never liked any that were available for the CoCo. But, I have to admit, I like the mouse that comes with *The Rat* better than even my MS-DOS mouse.

In fact, the two mice are very similar in construction. Both are high-quality digital mice with two action buttons. *The Rat's* mouse (doesn't that sound peculiar?) fits the hand very well, and suits the program. The two "rodents" complement each other nicely. Both buttons are supported, in most cases with a single and double click. This means you do not have to always scamper to the menu to get things done. In a lot of cases, the double click allows you to edit the defaults of the program.

Now, with all the good things I've said about the *The Rat*, I cannot go one further and say I thought it was perfect. One thing missing is an "Are you sure?" feature. My son accidentally wrote over some of his hard work by saving a screen with a name that had already been used, and there was no recovery. Another feature that's absent is a way to exit the program without turning off the computer. With such a good program, this seems a rather crude way of exiting. Also, I think the manual could be expanded, and a few sample pictures would be a nice addition.

After all the pros and cons are tallied, I still think this is the best and easiest of all the graphics packages I have used or seen. I can tell you how good the

package is, but you will not really appreciate *The Rat* until you see and work with it. I cannot wait to see someone who is good at drawing turn in a picture for the CoCo Gallery using *The Rat*. If you are thinking of buying another graphics package, just wait until you've seen this one. If you think you are not at all interested in owning a graphics package, I'll bet you'll change your mind. Once you've seen *The Rat*, Diecom will probably get some of your money.

(Diecom Products Inc. 6715 Fifth Line, Milton, Ont., Canada L9T 2X8, 416-878-8358; \$69.95 U.S., \$99.95 Cdn.)

— Dale Shell

Software

CoCo 2 & 3

Indiana Jim — A Fight for Survival

Imagine yourself on a beach with a vast ocean on one side, a dense forest on the other, and a band of vicious Indians chasing you as you plunge headlong into Indian territory. This all takes place in the opening of a unique graphics Adventure, *Indiana Jim*.

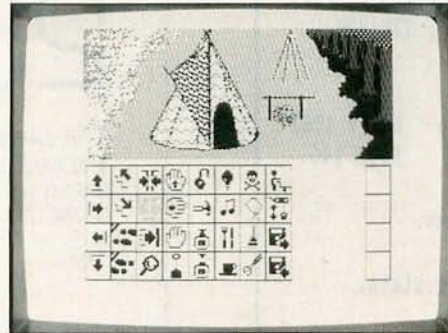

When the game begins, you set out to find a way back to civilization through Indian territory, a dense forest, caves, mountains, a desert and a town.

Indiana Jim, made by Lomiq, Inc., comes on two unprotected disks, requires a joystick and works on the CoCo 2 and 3.

The manual, in my opinion, is the only real flaw in this program because it never mentions the object of the game, nor is any information given that might help with the commands. However, this game is unique in that the software can be used by anyone of any language as it is based entirely on icons and symbols. This is basically the only thing the manual tells you other than the loading procedure for single or dual drives and the warranty information. The manual,

written in English, Spanish and French, explains the meanings of the icons that appear on the screen.

The screen is divided into two major parts. The top part is the graphics display and the bottom is the icon menu. In the menu are icons used for movement (the standard N, S, E and W) and other necessary actions for game play (GET, EXAMINE, KILL, etc.). Next to the icon menu is a space for the display of your inventory, which may hold no more than four objects at a time, and four boxes to show objects that were dropped on that particular screen.

The game is relatively difficult without the aid of a story line for reference, but, overall, it is most suitable for the intermediate Adventurer. I found it annoying that, in the game, you can easily die without warning. If you do need help, however, you can take a peek at the solution sheet of all 235 moves. Even if more instructions were given, accomplishing your goal would be no easy feat.

(Lomiq, Inc. CP 105, Succursale A, Jonquiere, Quebec, Canada G7X 7V8; \$28.95 U.S.; \$38.95 Cdn.)

— Glen Baisley

Reviewer Information

In order to continue to bring Tandy Color Computer users all the best information about new hardware and software products each month, we are expanding our independent review staff. Therefore, we invite you to join THE RAINBOW's elite fleet of reviewers.

You read THE RAINBOW because you love your Tandy Color Computer, so if you want a creative outlet and a chance to examine quality hardware and software, with your observations published nationwide, we want to hear from you.

Send us a cover letter with your name, address, occupation, list of equipment, areas of general interests, and a sample review of a CoCo product you are currently using. We look forward to your response. After all, we already see you have the best taste in computers.

Reply to:
Reviews Editor
THE RAINBOW
The Falsoft Building
P.O. Box 385
Prospect, KY 40059



◀◀ GIMMESOFT ▶▶



A new generation of Color Computer products

NEW ▶▶

GRAPHICS-25

◀◀ NEW

(512k CoCo III only)

Utilize the FULL 512k memory range of your CoCo III from BASIC for graphics! Create up to 25 ONBOARD HIRES SCREENS! Six new BASIC commands allow instant display switching while secretly drawing other screens. Save and load screens to and from disk. Copy one screen to another. Fast Graphics action, Smooth animation, and 100% Machine Language code. Requires DECB 1.0, DECB 1.1, or FKEYS III. Complete with documentation. Disk\$24.95

MULTI-LABEL III

(See July '87 review) Disk \$16.95

FKEYS III

(See April '87 review) Disk \$19.95

<CoCo III only>

Custom Palette Designer

(See Aug '87 review) Disk \$14.95

SIXDRIVE

Disk \$16.95

CoCo Max III

(CoCo III only)

More resolution, power, color, speed, tools, & type styles!!! Built in Animation! / Amazing Color Sequencing!!! Comes with HI-RES INTERFACE, MINILOAD/BAS, DEMO DISK, COCO SHOW PGM. Complete package \$79.95

AUTO DIM

(CoCo III only)

This hardware device protects your RGB or composite monitor, or your TV from IMAGE BURN after a few minutes of inactivity from your keyboard. Illustrated instructions and easy to install. Just..... \$29.95 (See January '88 review)

Now 2 styles

MPI-CoCo Locking Plate

Fits older MPI

Protects your CoCo III and Multi Pak Interface from destroying each other! Installs in seconds. MPI 26-3124 or 26-3024 & CoCo III 26-3334 only. Please specify MPI number 26-3024 or 26-3124 when ordering! Only \$9.95

NEW IMPROVED!

MAXSOUND

NEW LOW PRICE!

(128k or 512k CoCo III only)

Turn your CoCo III into a REAL digital audio sampler with HIGH quality audio reproduction. Easily add exotic effects, stuttering, speed shifting, sequencing, and reverse audio to BASIC or ML programs or GRAPHICS! Imagine recording any Voice, Music, or Sound effect and being able to use these DIGITAL recordings in your own programs! 3 disk set includes: INTERFACT/BIN - ML driver for sound effects. G&M/BAS - Adds sound effects to Graphics, SHOWTIME and DEMO disks. SCOPE/BAS - Turns CRT into a Digital Oscilloscope to look at MAXSOUND waveforms. Some possible uses are: Haunted house sound effects, Telephone answering machine, or Talking door bell. CALL FOR DEMO \$59.95

NEW ▶▶

V-Term Terminal Emulator

◀◀ NEW

(128k or 512k CoCo III only)

V-Term is one of the most advanced terminal programs for the CoCo III ever!!!

FEATURES: VT-100, VT-52, and standard CRT emulations. Full use of 512K, 80X28 text or graphics characters, Windows & Multi-tasking(Disk Basic!), RAMDISK like buffer, Xmodem, Xon/Xoff, Monochrome monitor support, Capture buffer, Snapshot, Conference mode, and much much more! Complete with documentation. Disk..... \$39.95

PYRAMIX

(CoCo III only)

This 100% machine language arcade game was written exclusively to take advantage of your CoCo 3. The colors are brilliant, the graphics are sharp, and the action is hot! (See Dec. '87 review) Disk..... \$19.95

Kung-Fu Dude

(CoCo I/II/III)

This is the long-awaited response to the huge demand for a Kung-Fu program for the CoCo. Destroy opponents and evade obstacles as you grow even closer to your ultimate objective! (See Feb. '88 review) Disk..... \$24.95

CHAMPION

(CoCo I/II/III)

Become a superhero in your fight to rid the world of the evil forces of Mr. Bigg in this action adventure. The combat is hot and heavy and requires a fast joystick! (See May '87 review) Disk..... \$19.95

White Fire of Eternity

(CoCo I/II/III)

Enter the age of monsters, magic, and adventure. Here you will search for the legendary power of White Fire throughout the Forbidden Wood and dark caverns. (See Dec. '86 review) Disk..... \$19.95

NEW ▶▶

In Quest of the Star Lord

◀◀ NEW

A new animated graphics adventure for the CoCo III from the author of the Hall of the King Trilogy and Kung-Fu Dude! Enjoy the mixture of science and fantasy as you quest for the Phoenix Crossbow, the only thing that can save you in the post-holocaust world. 4 Disk sides of adventure! Outstanding 320x200 graphics! CoCo III 128k Disk \$34.95

Technical assistance: 7pm to 9pm
Orders: 9am to 9pm Eastern time
On-line orders and up to date
information: Delphi's CoCo Sig

GIMMESOFT
P.O. Box 421
Perry Hall, MD 21128
301-256-7558 or 301-256-2953

Add \$3.00 for shipping and handling
Add \$2.00 for COD (USA only)
MD residents add 5% sales tax
VISA/MC/Check/Money Order/COD



The following products have recently been received by THE RAINBOW, examined by our magazine staff and issued the Rainbow Seal of Certification, your assurance that we have seen the product and have ascertained that it is what it purports to be.

The Comprehensive Color Computer Anti-Clutter Kit, a reference guide designed to supplement and condense the information in Tandy manuals, including definitions, color tables, graphics codes, memory map, peeks/pokes, explanations of error codes, etc. *Heritage House Lithographers, P.O. Box 629, Hungerford, TX 77488; \$9.95.*

Laser Surgeon: The Microscopic Mission, an educational Adventure in which the player is a laser surgeon directing a healing laser probe through an injured person's body to the brain. For the CoCo 3. *Activision, Mountain View, CA 94039; \$29.95. Available in Radio Shack stores nationwide.*

Mini Database, a menu-driven 32K database designed to keep track of from 50 to 100 entries. For the CoCo 1, 2 and 3. *Tothian Software, Inc., Box 663, Rimersburg, PA 16248, \$14.95.*

MJK, a disk operating system featuring key repeat, full screen editor, line editor, modified editing commands and unabbreviated error messages. For the CoCo 1, 2 and 3. *CoCo Connection, 5003 B St., Philadelphia, PA 19120, (215) 457-1809; \$39.95.*

RADIOLOG +3, a program designed to keep a station log for an amateur radio station; comes with a "key" for the right joystick port. *Sunrise Software, 8901 NW 26th St., Sunrise, FL 33322, (800) 628-2828, Ext. 552; \$19.95 plus \$2 S/H.*

REMUSIC 1.0, a music program for CoCos 1 and 2 that has now been updated for the CoCo 3. *Codis Enterprises, 2301-C Central Drive, Suite 684, Bedford, TX 76021, (817) 293-1202; \$12.*

RS-232 Cable and RS-232 Switcher, an extender cable and a switcher that allows you to switch between several RS-232 devices without disconnecting them. For the CoCo 1, 2 and 3. *Radcomp Computers, 919 E. Lemon #207, Tempe, AZ 85281, (602) 894-6489; 2-way Switcher, \$10; 3-way Switcher, \$11.50; Extender cable, \$4.*

System 5, a graphics generator that features 320-by-192 16-color graphics, pull-down and page-down point-and-click menus, full screen workspace, nine different fonts, and more. It requires 512K and is for the CoCo 3. *Elec-Soft, 803d W. 47th St., Norfolk, VA 23508, (804) 451-1255; \$12.*

Telewriter-128, an updated version of the *Telewriter-64* word processor for the CoCo 3. Features include macros, print preview capability and instant online help. *Cognitech, 704 Nob Ave., Del Mar, CA 92014, (619) 755-1258; \$79.95.*

Thexder, an arcade action game in which the player pilots a robot through caves, vast cargo holds and spaceship interiors to do battle with 20 types of aliens. Supplied on a ROM pack, for the CoCo 3. *Sierra On-Line, Coarsegold, CA 93614; \$24.95. Available in Radio Shack stores nationwide.*

VIP Integrated Library, an integrated software system that includes *VIP Terminal, VIP Writer III, VIP Calc, VIP Database, VIP Speller* and *VIP Disk-Zap*. All programs except *VIP Writer III* work on CoCos 1 and 2. Upgrades are available. For the CoCo 3. *SD Enterprises, P.O. Box 1233, Gresham, OR 97030, (503) 663-2865; \$149.95.*

Wargame Designer, a 128K menu-driven program that allows you to create your own military simulations. No programming knowledge is required. For the CoCo 3. *SPORTSware, 1251 S. Reynolds Road, Suite 414, Toledo, OH 43615, (419) 389-1515; \$29.*

F First product received from this company

The *Seal of Certification* program is open to all manufacturers of products for the Tandy Color Computer, regardless of whether they advertise in THE RAINBOW.

By awarding a *Seal*, the magazine certifies the product does *exist* — that we have examined it and have a sample copy — but this *does not* constitute any guarantee of satisfaction. As soon as possible, these hardware or software items will be forwarded to THE RAINBOW reviewers for evaluation.

— Lauren Willoughby

Halifax Dartmouth CoCo Users Group, Eugene Naugler, P.O. Box 572, Dartmouth, Nova Scotia, B2Y 3Y9

Colour Computer Halifax User Group (CoCo Hug), Paul A. Power, 6354 London St., Halifax, Nova Scotia, B3L 1X3, (902) 455-6341

ONTARIO

ESSA Color Computer Club, David Morrow, 10 Berwick Cres., Angus, Ontario, L0M 1B0, (705) 424-6985

Kingston CoCo Club, Kenneth Bracey, 316 Westdale Ave., Apt. 4-C, Kingston, Ontario, K7L 4S7, (613) 544-2806

K-W CoCo Club, P.O. Box 1291, Station C, Kitchener, Ontario, N2G 4G8

London CoCo Nuts Computer Club, Harry K. Boyce, 180 Concord Road, London, Ontario, N6G 3H8, (519) 472-7706

Niagara Regional CoCo Club, Gerry Chamberland, 6843 Cumberland Crt., Niagara Falls, Ontario L2H 2J9, (416) 357-3462

Ottawa 6809 Users Group, Norm Shoihet, 1497 Meadowbrook Road, Ottawa, Ontario, K1B 5J9, (613) 741-1763

Sarnia Computer Users Group, J. Verdon, P.O. Box 1082, Sarnia, Ontario, N7T 7K5, (519) 344-6985

Burlington Color Computer Users Group, Lawrence T.J. Coffey, 33 Drakes Drive, Stoney Creek, Ontario, L8E 4G4, (416) 573-6889

Durham 80-C Computer Club, Tony Kernohan, P.O. Box 95, Whitby, Ontario, L1N 5R7, (416) 728-6416

Trenton Colour Cats, Perry Skipton, 21 Janlyn Cres Appt. 5, Belleville, Ontario, K8N 1L1, (613) 966-9291

The Toronto Color Computer Club, John T. Rawlinson, #361 St. Germain Ave., Toronto, Ontario M5M 1W6, (416) 782-5718

Gateway Colour Computer Club, Jim Ross, P.O. Box 492, North Bay, Ontario, P1B 8J1, (705) 472-4931

QUEBEC

Club d'Ordinateur Couleur du Quebec, Inc., Centre de Loisirs St-Mathieu, 7110-8e Ave., St-Michel, Montreal, Quebec, H2A 3C4, (514) 729-8467

Club Micro Ordinateur de Montreal-Nord, Christian Champagne, 12365 Blv. Langelier #7, Montreal-Nord, Quebec, H1G 5X6, (514) 323-5958

Les CoCophiles, Robert Chartrand, 17 Bord-de-l'eau, Repentigny, Quebec, J6A 3K2, (514) 581-1385

Club ORCO-RS, Jacques Bedard, 33 Lisiere, St-Constant, Quebec, J0L 1X0, (514) 632-4311

Club CoCo APPE, Andre Patenaude, 10870 Bois de Boulogne, Montreal, Quebec, H3M 2X1, (514) 331-8418

SASKATCHEWAN

Saskatoon Color Computer Club, L. Curtis Boyle, 35 Bence Crescent, Saskatoon, Saskatchewan, S7L 4H9, (306) 382-1459, BBS (306) 384-8040

FOREIGN

ARGENTINA

Freecoco Club, Novoa, Miguel Angel-Ing. Duarte, Omar, Mendez de Andes 799, Buenos Aires, Capital Federal 1405, Argentina, phone 431-2501

AUSTRALIA

Blacktown City TRS-80 Colour Computer Users Group, Keith Gallagher, P.O. Box 264, Riverstone, New South Wales, 2765, Australia, (02) 627-4624

COCOPUG, Harry Murphy, 8 Lois Court, Regentville, New South Wales, Australia, 2750

CoCoHUG (Color Computer Hobart Users Group), Robert Delbourgo, 15 Willowdene Avenue, Sandy Bay, Hobart, Tasmania, Australia 7005

Sunshine Color Computer Club, Stephen Jones, P.O. Box 111, Sunshine, Victoria, Australia, 3020

Pine Rivers/Peninsula User Group, B. Clarke, C/-31 Brooks Rd., Bray Park, Queensland, Australia, 4500, (07) 205-4879

Australian Christian Users Group, Lieutenant Raymond L. Isaac, 57 Wittenoom Street, Collie, Western Australia 6225, phone (097) 34-1578

COLOMBIA

CoCo-Byte, Fabian A. Rodriguez, Avenida 4A #49N-60 or A.A. 5976, Cali, Colombia, 640705-649165

ISRAEL

The Mid-East CoCo Club, J. Yosef Krinsky, 526/11 Kiryat Kaminitz — Neve Yaacov, Jerusalem, Israel

MEXICO

Mexcoco Users Group, Sergio Waisser, Paseo de la Soledad #120, Mexico City, D.F., 53920, Mexico, phone 294-36-63

First Color Computer Users Group of Hermosillo, Arturo Fernandez Diaz-Gonzalez, Javier de Leon No. 708, Colonia Pitic, Hermosillo, Sonora, Mexico

the NETHERLANDS

Color Computer Club Benelux, Jorgen te Giffel, Eikenlaan 1, 4641 GB Ossendrecht, the Netherlands

CoCoCE, J. Slaats, Chopinlaan 11, 5653 ET Eindhoven, the Netherlands, (040) 512-222

PERU

Piura Color Computer Club, Carlos Alvarez, Box 142, AV. Guillermo Irazola, J-6 URB. Miraflores Castilla, Piura, Peru, phone (074) 327-182

PUERTO RICO

Puerto Rico Color Computer Users Club, P.A. Torres, Cuernavaca 1699, Venus Gardens, Rio Piedras, Puerto Rico 00926, Phone (137) 755-7598

WEST GERMANY

First CoCo Club Hamburg, Theis Klauberg, Krietkamp 27A, Hamburg 65, West Germany, 2000, (040) 536-3676

The Greatest German CoCoCooks, Michael Herbes, Dorfstr 23, 4320 Hattinger, West Germany

new clubs

ALABAMA

Cocost of Central Alabama (CoCoA), Phil Shanholtzer, Rt. 4 Box 489 BB, Prattville, 36067, (205) 365-3501

LOUISIANA

Bayou Country Color Computer Club, Darrin J. Martin, 3206 Susan St., Houma, 70363, (504) 851-4014

OHIO

Ohio Valley Association of Computers, Bill Davis, 142 Courtland, Weirton, 26026, (304) 797-8321 and (304) 797-8671 (online)

The Utopia Network, Bruce Uher, 145 1/2 Park Ave., P.O. Box 1274, Coshocton, 43812, (614) 622-4061

OREGON

Computer Research User's Group, Tom Sanders Bair Jr., P.O. Box 370, Clackamas, 97015, (503) 668-8397, BBS

TENNESSEE

Bradley County Personal Computer Users Group, C.A. Bailey, P.O. Box 2611, Cleveland, 37311, (615) 344-3950

VIRGINIA

Southwestern Va. Color Computing Club, Richard Sutphin, Rt. 1 Box 20, Henry, 24102, (703) 365-2018

WEST VIRGINIA

Huntington Area Color Computer Symposium, Jim Bush, P.O. Box 391, Lesage, 25537-0391, (304) 736-5314

WYOMING

Cheyenne CoCo Club, Craig Sullivan, 4500 Parkview Drive #303, Cheyenne, 82009

CANADA

QUEBEC

CoCo Club 2000, Marc-Andre Gagnon, 381 Blvd. Richelieu, St-Basile-le-grand, Quebec, Canada J0L 1S0, (514) 658-5983

128K BASIC COCO 3 DISK or CASSETTE

THE DIRECTOR Produce hires PICTURE, SOUND and COLOR ANIMATION shows! Completely MENU driven with easy editing. Includes extra programs to CONVERT most hires pictures, and to SHARE your shows with others! Great for VCR presentations! See April '88 RAINBOW REVIEW! Requires predrawn pictures. SAVE \$10... Now only..... \$29.95

MY ARTIST DRAW and PAINT PICTURES in all 4 hires 320 & 640 by 192 modes! Up to 16 COLORS and 64 HUES! Simple but POWERFUL keyboard & joystick commands for undistracted, FULL SCREEN drawings! Fast ML Save & Load..... \$14.95

SAVE \$15 Both the above... \$39.95
PHONE: 603-524-0116

128/512K OS-9 L2 COCO 3 DISK

ECONOMIST Perform ECONOMIC ANALYSIS to compare various combinations of COST and INCOME items. Computes PRESENT and FUTURE LIFE CYCLE WORTH for up to 100 Single, Series and Gradient dollar amounts! Quickly edit and recompute for SENSITIVITY ANALYSIS including GRAPH of results, and PRINT-OUTS. Pull-Down Menus, Windows and Prompts! Requires OS-9 L2 & BASIC09. SPECIAL INTRODUCTION PRICE..... \$29.95



30 DAY SATISFACTION GUARANTEE
Send Check or Money Order.
Please add \$2 Shipping & Handling.
SEESOF PO Box 574, Beaufort, SC 29901

TANDY ADD-ONS

For Tandy 1000, SX, TX

10 Meg Hard Card

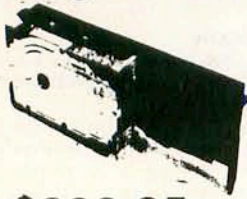

\$299.95

1000, SX, TX

20 Meg Hard Card



\$349.95

1000, SX, TX

30 Meg Hard Card

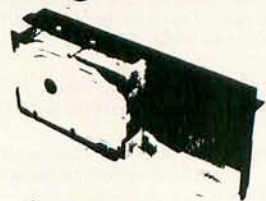

\$399.95

1000, SX, TX

Hard Drive Kits



10 Meg	\$279.95
20 Meg	\$339.95
30 Meg	\$379.95
40 Meg	\$499.95



NEW TANDY

1000, SX, TX
49 Meg Hard Card
32 MS (speed)

\$599.95

Rodime

NEW Cardinal Modems

2400 Baud 300/1200/2400

(Hayes Compatible)

Complete with software manuals

ONLY **\$149.95**

TANDY 1000

1000, SX, TX, 3000, 4000

1000, SX, TX

Cards

300/1200 Modem	\$119.95
300/1200/2400 Modem	\$149.95
Mini IO	\$79.95
2 Meg Board	\$169.95

2nd Floppy

360K	TEAC	\$119.95
720K	Mitsubishi	\$99.95
3 1/2"	Mitsubishi	\$119.95



1000, 1000A

Memory Cards

Zucker Memory

• DMA & 512K **CALL**

Zucker Multifunction

- Serial
- Real Time Clock
- 512K DMA
- Software

CALL

Tandy 3000 & 3000HL

Hard Drive Kits

Includes Drive, Controller & Cable

20 Meg	\$399.95
30 Meg	\$599.95
40 Meg	\$699.95
80 Meg	\$999.95

Tandy Model 3, 4, 4P

Hard Drive Systems

External

Complete - ready to run

10 Meg	\$499.95
20 Meg	\$699.95



Tandy 1000,
1000SX,
3000 & 3000HL

Tape Backup

20, 30, 40 Meg Tape Backup	\$399.95
60 Meg Tape Backup Archive	\$659.95

TRUE DATA PRODUCTS

115 So Main Street
Uxbridge, MA 01569

Tel. 617-278-6555

1-800-635-0300

Hours: 9 a.m.-6 p.m., Sat. 10 a.m.-4 p.m.

NEW DISK DRIVES

Starting at

89⁹⁵

with case &
Power Supply
129.95

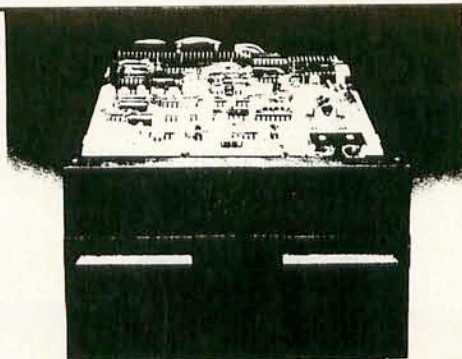

TANDON MPI TEAC

Speed 6ms tk to tk and up
Capacity 250k unformatted
Tracks 40

Warranty *now* 1 Year

New Low Price!

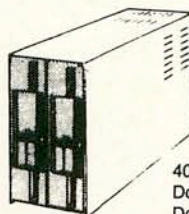

40 Tks 6Ms
Double Sided
Double Density

40 or 80 Tracks

1/2 Hght. Teac/Panasonic

**1 YEAR
Warranty!**

SATISFACTION GUARANTEED!!

ALL DRIVES FULLY TESTED AND WARRANTEED

We carry only the finest quality disk drives
no seconds • no surplus

Free Software for Drive 0 Systems

CoCo Checker...Test roms, rams, disk drives and & controller printer, keyboard cassette & more.
Tape/Disk Utility...Transfers disk to tape and tape to disk.

169⁹⁵ Drive 0

- Full Ht Drive
- Single Case
- Heavy Duty Power Supply
- 2 Drive Cable
- Gold plated contacts
- Controller & manuals

189⁹⁵ Drive 0

- Double Sided Slim Line Drive
- Case holds 2 slim line drives
- Heavy Duty Power Supply
- 2 Drive Cable
- Gold plated contacts
- Controller & Manuals

289⁹⁵ Drive 0 & 1

- 2 Double Sided Slim Line Drive
- Case holds 2 slim line drives
- Heavy Duty Power Supply
- 2 Drive Cable
- Gold plated contacts
- Controller & Manuals

Other Drive Specials

Drives cleaned, aligned & tested, **29⁹⁵**

119⁹⁵

2nd Drive
for new Radio Shack
includes:

- Slim Line DS/DD Drive
- Cabling & Instructions
- Mounting Hardware



Full Ht Drive	89⁹⁵
Full Ht Drive Ps/Case.....	129⁹⁵
Slim Line Drive.....	99⁹⁵
Slim Line Drive Ps/Case...	139⁹⁵
2 Slim Drives Ps/Case	239⁹⁵
Disk Controller	59⁹⁵

Single Ps & Case	44⁹⁵
Dual 1/2ht Ps & Case	54⁹⁵
Dual Full Ht. Ps & Case	79⁹⁵
Disk Controller	59⁹⁵
10 Diskettes with free library case	9⁹⁵

Dealer Inquiries Invited

617-278-6555

We welcome

- Visa/Mastercard  
- Checks (allow 2 weeks for clearing)
- C.O.D. Add \$2.



TRUE DATA PRODUCTS

9 South Main Street
Uxbridge, MA 01569
617-278-6555

Hours: Mon.-Sat., 9-6 (EST)

Call us today! 617-278-6555

Order Toll Free 1-800-635-0300

The CoCo Power User

By Alan J. Corson

Power User: the phrase conjures up visions of a Pierre Cardin-bespeckled, Gucci-shod, silk- and tweed-clad micro guru, crunching away on massive spreadsheets, sorting and searching huge databases, and amalgamating all with his instant spell-checking, thesaurus-spouting, automatic outlining, window-framing word processor running on his \$10,000, 4-Mb, 12-MHz Belchfire Turbo 386. Phew! This is the image of the Power User that has been touted within the MS-DOS and Macintosh corporate worlds. How can our humble little CoCo 3 ever measure up to supporting such an image? It can, with a whole lot less fuss, bother and, above all, cost!

With its simple beginnings in 1980, the 4K CoCo began introducing a whole new world of computing to many individuals who only 10 years earlier had their sole programming experience on large, intimidating, remote batch-oriented multi-megabuck mainframes. With its limited memory, the CoCo could not then compete as a business system. As memory technology advanced, however, the CoCo's memory also grew to its 64K-addressable limit.

Alan Corson, an Air Force major presently serving in Cairo, is an information systems engineer who sees a growing market for the CoCo as a small-business machine.

But to get to that memory, something else had to be provided to overcome the 32K limitation hard-coded into Color BASIC.

The folks at Microware and Tandy had the answer: OS-9 Level I, a proven operating system already running on 6809 machines across the country in real-time process control applications, a very demanding industrial environment. Modeled after UNIX (with some very smart improvements in efficiency), OS-9 provided access to all of the CoCo's memory, plus a whole lot more: tree-structured hierarchical filing systems, extremely flexible input/output capabilities, multitasking and multiuser features. By the way, all these capabilities were (and still are) available for under \$100 from Radio Shack, 10 times less expensive than UNIX (actually XENIX, the PC version of mainframe UNIX).

In 1983, OS-9 with a 64K CoCo was a whole lot of computing horsepower, but with very little applications software available. "Little feller" was still relegated to acting as a development machine in homes or as an educator in schools. However, dedicated CoCo-Nuts perceived a need and over the next three years, small-business-oriented software began to appear: *Telewriter*, the VIP series, and the Elite series, all under RS-DOS. Then OS-9 products followed: *DynaCalc*, *Data Bank* (licensed as *Profile* by Tandy), *DynaStar*,

Stylograph, the X-series from Microtech, and the Business Application series from Computerware.

All along, our archetypical Power User still turned up his nose at the CoCo because of the memory limitations imposed by the 16-bit address-bus limitation of the 6809. (One fact still escapes the 80XX community: The 6809 internally is a 16-bit processor, fully as capable as an 8088, with a RISC-like (Reduced Instruction Set Computer) machine language. In July 1986, Tandy shattered the memory limitation with the announcement of the Color Computer 3: 128K RAM, expandable to 512K, and able to run OS-9 Level II at 2 MHz. Software developers scrambled to update their software to use the windowing facilities of Level II, but the vast majority of OS-9 software would still run without major modification, thanks to the stringent software-developers standards inherent within the OS-9 environment. Those standards produced compact, modular, relocatable, re-entrant code.

Now the CoCo 3 has the hardware, the operating system, and the applications software capable of supporting a potential Power User. How do I know? I *am* one! Yes, I'm the proud owner of a 512K CoCo 3 liberally stuffed with RGB monitor, two DSDD drives, one DSQD 80-track drive, MPI, RS-232 Pak, and a Disto 512K Super RAM Disk Pak. I use this system daily at

work, cruisin' with my CoCo while my MS-DOS compatriots are steaming and fussing on their -XT "boat anchors." How do I accomplish this, and how do I qualify as a Power User? Stick around, and watch the magic of OS-9 Level II harness for work!

Each morning when I fire up "Euclid" (my CoCo 3), in goes a Level II System disk with three procedure files: StartUp, ColdStart and Wset. StartUp starts the clock, initializes my system and custom-configures it for my use. ColdStart formats and loads up the RAM disk with all my executable files (about 382K worth) from a floppy disk image loaded in the 80-track drive (d2). Next, the simple file Wset starts the real Level II magic. Here it is:

```
chx /r0/cmds
chd /r0
wcreate -z
/w1 -s=2 00 00 80 24 03 02 02
/w2 -s=2 00 00 80 24 05 02 02
/w3 -s=2 00 00 80 24 07 02 02
/w4 -s=2 00 00 80 24 05 02 02

shell i=/w1&
shell i=/w2&
shell i=/w3&
shell i=/w4&
```

Kinda cryptic, isn't it? Not to worry, a short perusal through the OS-9 Level II Operating System Manual "Getting Started" and "Windowing System" sections will make it all clear (really!). Allow me to help: First, Euclid switches to his fast-access RAM Disk, /r0, then invokes the windowing utility Wcreate. The next four lines tell Wcreate to set up four windows, each 80 columns by 24 lines. Each window will have black borders and black backgrounds. The foreground colors will be green, amber, blue and amber, respectively. This gives me four different "terminals": Green, amber, blue and amber (again). A carriage return tells Wcreate that it is finished, and the last four lines set up shell environments in each of the windows.

I now have four CoCos at my disposal, each displaying an 80-column screen in a different color. Let's call them /w1, /w2, /w3 and /w4. Actually I have five, because the basic green screen (known as /term, or the hardware screen) is always available to return to, should I need it for System Operator housekeeping functions. In fact, that is the screen I'm still looking at after Wset gets finished. So, if I press the CLEAR key once, I am in /w1, a green on black

terminal displaying the OS9: prompt of an active shell. I start up a word processor here, Computerware's *Screen Star*. Five seconds later, *Screen Star*'s opening help menu is visible, waiting for commands. If I press the CLEAR key again, I'm in /w2 now, an amber terminal, and I'll start up my communications package, *Color Connection III*. Press the CLEAR key again, and I'm in /w3, a bright blue (cyan) on black terminal (interesting combination, but still very readable). Here I need my spreadsheet, and *DynaCalc* comes to life. One more press of the CLEAR key and /w4 appears: *Profile*, my database application, is started. Now, with the CLEAR and SHIFT-CLEAR key combinations at my disposal, I can instantly switch between word processing, data communications, spreadsheet operations, or database work. How much memory am I using for all this? I'll ask my SysOp, /term. CLEAR key to all green, and enter the command mfree. Euclid responds with the following:

Blk	Begin	End	Blks	Size
---	-----	-----	----	----
	24	48000	77FFF	18 192k
			===	====
	Total:		18	192k

No sweat! Euclid still has 192K of RAM left over. OK, I have all this computing power at my disposal, how do I qualify as a Power User?

At my job here in Cairo, I assist the Arab Republic of Egypt's Armed Forces in developing their command, control and communications capabilities. Also, as the token communications-electronics engineer on the staff of the Office for Military Cooperation, I act as the communications officer for the agency. This responsibility calls for planning, budgeting, and managing all the "comm" assets needed to support our operations at the American Embassy. Recently we had to upgrade our radio network rather rapidly, and the word came down from "on high": "Al, you have \$20,000 to spend, but you must do it in five days."

OK, Euclid, let's rock and roll! First, a *DynaCalc* spreadsheet to cost out alternatives and decide on the best solution. Next, a search of the *Profile* spares database and personnel listing to find out how much extra equipment to order. Switch back to the spreadsheet and add the quantities. Save that spreadsheet to a file. Finally, prepare letters to the procurement people with *Screen Star*, merging the spreadsheet

file into the letter to provide quantities, part numbers, and total estimated costs. Total time spent? Two days, with the majority of the time spent researching catalogs and obtaining current price information. Result: Money effectively spent quickly to meet a critical time-sensitive need. Am I so great? No, but Euclid, OS-9 and a whole host of CoCoNut software programmers sure made me look good!

What is my point here? Simply that the CoCo 3 has "arrived" as an effective small-business office automation tool. Euclid's ability to instantly switch among the three major business applications of word processor, spreadsheet and database allowed me to seamlessly construct a product, with no breaks in thought or action. That is Power User computing, and throughout this process, Euclid wasn't even breathing hard! When I switched from one task to another, the first task was "marking time" as I worked on the second task. With the Belchfire 386, that's normal. With Euclid, that's a waste! If I had been really good, (and my spreadsheets and databases were big enough), Euclid could have been recalculating a spreadsheet, searching a database, and listening for my fumbling fingers with the word processor, all at the same time!

Yes, there are many other systems able to do the same thing, but Euclid (or any other similarly equipped CoCo 3) can support this type of Power User computing for under \$1,500. MS-DOS can't match that; XENIX, OS/2, Concurrent DOS 386 can't match that; *DesQview*, *GEM* or Microsoft *Windows* can't match that on any 80XXX-based system on the market today.

With such an elegant solution at hand here, any engineer would first test for the optimum (which I feel has been successfully demonstrated here), then generalize the solution. Remember the multiuser capabilities inherent in OS-9? With LOGIN patched from OS-9 Level I to Level II (courtesy of Greg Law, as reported by Msrs. Esposito and Libra in their "Doctor ASCII" column, November 1987) and TSMOR activated, a second user can be added via an RS-232 port and an inexpensive terminal. . . . I'm getting ahead of myself. That is a subject worthy of an entire article.

From Cairo, Egypt — *maa' salaama*, y'all!

(Questions or comments may be directed to the author at AMEMB/OMC-AV, Box 29, FPO NY 09527-0051.)

Lack of Infinite Precision

I have an 'E' board CoCo, which I have upgraded to 64K. Since the upgrade, my CoCo no longer subtracts correctly. The problem seems to occur when I use variables to store the numbers. For example, if I set A=\$123.49 and B=\$56.89 then subtract B from A, I might get \$66.60 or something like \$66.590003. Are my suspicions about the upgrade correct or am I way out in left field?

Richard Jones
Quincy, IL

RX The problem is not related to your upgrade, but to decimal-binary floating-point conversion and lack of infinite precision. Decimal fractions 0.1, 0.01, etc., are repeating binary fractions and, on occasion, some of the digits get lost. This is analogous to using pencil and paper to divide 10 by 3, yielding 0.33. If you then multiply 0.33 by 3, you get 0.99, *not* 1.0. If infinite precision were possible, in both cases, the results would be exact. In your programs, use PRINTUSING instead of PRINT and round the results to help alleviate this problem.

If You Fall Into an Error Trap

I have a new CoCo 3 with DOS 1.1. While recently experimenting with the error-trapping routine, I found that an FC Error comes up as Error Number -1. My manual says it is Error Number 4 and that Error Number -1 does not exist. What gives?

Doug Lute
Clymer, PA

RX I assume you were using an IF statement. On the CoCo and other computers such as the IBM PC and Apple II, which use Microsoft BASIC, the logical value TRUE is a -1.

Richard Esposito is a principal engineer with BDM Corp. He holds bachelor's, master's and doctorate degrees from Polytechnic Institute of Brooklyn. He has been writing about microcomputers since 1980.

Richard Libra is a simulator test operator for Singer Link Simulation Systems Division.

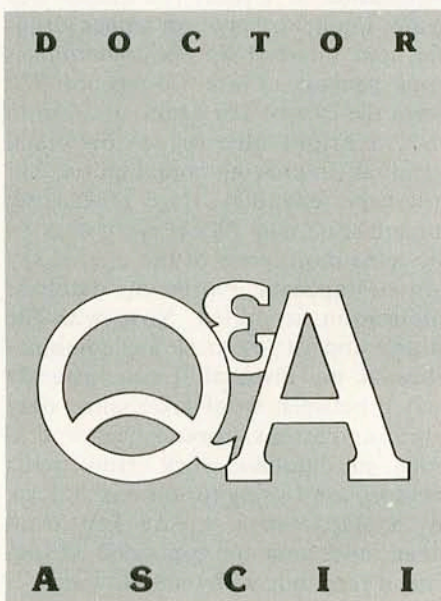

By Richard E. Esposito
Rainbow Contributing Editor
with Richard W. Libra

Controller Restrictions

When it is stated that a program cannot run with the disk controller plugged in, does that mean there isn't enough memory for the computer to run the program and work the disk drive, or does that mean the program has some machine language coding in it that cannot work if the controller is plugged in?

Omri Goren
Reseda, CA

RX Unfortunately, I cannot give you a blanket rule; it could be either.

High Poking Disk BASIC 1.1

I read recently about someone whose Disk BASIC 1.1 would accept the high speed poke without any trouble when doing input and output. I also have Disk BASIC 1.1, but my computer puts random characters on the screen and changes some of the program currently in memory. It also damages files on my disk. Are there any hardware fixes I can do to make the high speed poke work with my disk controller?

Jeff Bradley
Walkerville, MD

RX The incompatibility with the 2MHz clock speed is not due to the version of Disk BASIC, but the disk controller hardware itself. The older disk controllers that required 12 volts and were designed for the CoCo 1 cannot handle this speed. If you have one of these controllers, it is best to acquire a newer controller that is rated for 2MHz. While the CoCo 3 to a large degree is software-compatible with the CoCo 1 and 2, from a hardware standpoint (although the BUSS is the same), it is a totally different machine.

Swapping Keyboards

I have a 64K CoCo 2 on which the X key no longer works. Is the keyboard matrix on the CoCo 3 keyboard the same as on the CoCo 2 keyboard? If so, can I replace it with a new CoCo 3 unit? I realize that a few new keys will not be recognized by the CoCo 2, but that is not a problem.

Ronald Landwehr
Wheeling, IL

RX The CoCo 3 keyboard (Radio Shack Part No. AXX-0245) is a drop-in replacement for a CoCo 2. If used with an older CoCo 1, an adapter for the mylar cable may be required.

Misalignment Messes Communication

I have a 512K CoCo 3 and two disk drives. I have found that head alignment on one drive can get so far out that programs saved on one drive cannot be read on the other. This fact is not immediately obvious; the problem first appears in "backup" failures, but only erratically. Will the J&M Systems "Precision Alignment Disk & Memory Minder Manual S/S" advertised in THE RAINBOW allow me to do the head alignment required to keep this problem under control?

Ralph C. George
Anchorage, AK

RX If the problem is misalignment, the kit will help; but if it is a chronic problem, the money would be better spent in buying a newer replacement drive. This is especially true if the drive is one of the original, gray-housed RS full-height drives made by T.E.C.

Accessing 64K

I have a 64K CoCo 2 (32K RAM) and a cassette drive. Do I need to install a chip upgrade in order to get the full 64K RAM?

Paul Demick
Stephentown, NY

R_x Access to more than 32K, when using even a 512K CoCo 3, is limited not by the hardware but by the ROM software.

Searching for the Elite

About five years ago I purchased the program Elite * File from Radio Shack, but I can no longer find documentation for it. Would you happen to have the address for Elite Software, Inc.?

Mike Brunkow
St. Joseph, MO

R_x As of March 1986, the address of Elite Software was 201 Penn Center Blvd., Pittsburgh, PA 15235, (412)795-8492. Advertisements for their software last appeared in THE RAINBOW in that month.

80-Column Boot-Up in Multi-Vue

I was disappointed with Multi-Vue in that the system boots up in 40-column mode. Is there any way to fix this?

See pg 159

Joel Gray
Baton Rouge, LA

R_x Thanks to Kent Myers, changing Offset \$3A99 of BShe11 from \$06 to \$07 will make the default 80 columns.

2 Into 3 Might Go

Is there a way to upgrade my 64K CoCo 2 to 512K and make the language compatible with the CoCo 3?

Jason Lattimer
Canal Winchester, OH

R_x J & R Electronics can supply you with their 512K Banker II upgrade for your CoCo 1 or CoCo 2, but with it, you will need custom software for the extra memory as it is not mapped in the same way as on the CoCo 3. Unless you write your own, the supplied software allows the extra memory to be used as a print spooler and/or a RAM disk.

RAM disk software for OS-9 Level I is also included.

A New Hybrid: The Cocatari?

Is there a way to connect the port on the CoCo 2 to the port on the Atari 2600 and be able to operate in Atari BASIC?

William Mikrut
Chicago, IL

R_x Even if the hardware interface were worked out, it would do you no good. The Atari uses a 6502 micro-processor while the CoCo uses a 6809E, and they have different machine language instruction sets.

For a quicker response, your questions may also be submitted through RAINBOW's CoCo SIG on Delphi. From the CoCo SIG> prompt, pick Rainbow Magazine Services, then, at the RAINBOW> prompt, type ASK for "Ask the Experts" to arrive at the EXPERTS> prompt, where you can select the "Doctor ASCII" online form which has complete instructions.

\$UPER \$ALE!

40% TO 33% OFF!!

GREAT VALUES
ORDER NOW!!

COMPATIBLE
WITH COCO III

30 DAY
UNCONDITIONAL
MONEY-BACK
GUARANTEE!!

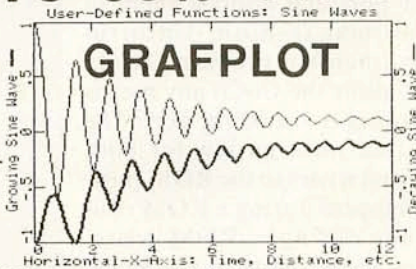

- * AUTOMATICALLY LOADS DATA FROM MOST POPULAR SPREADSHEETS.
 - * 291 GRAPHING SYMBOLS AND UNLIMITED OVERLAY OF DATA.
 - * AUTOMATICALLY SCALES AND LABELS ALL THREE OF THE AXES.
 - * CALCULATES MATH FUNCTIONS, INTEGRALS AND MOVING AVERAGES.
 - * FULLY AUTOMATIC, MENU DRIVEN W/ COMPLETE ERROR TRAPPING.
 - * FULL-PAGE SCREENPRINTS ON ANY PRINTER. SPECIFY WITH ORDER.
- REQUIRES 32K EXT. BASIC: TAPE - \$25.00 DISK - \$30.00
~~TAPE - \$40.00 DISK - \$45.00~~

NEW!! **Picture Perfect** NEW!!
PRINTER UTILITY

UNIVERSAL SCREENPRINT PROGRAM

- * COMPATIBLE WITH COCO III!!
 - * "PERFECTLY SIMPLE" TO OPERATE - "SIMPLY PERFECT" RESULTS!
 - * "PERFECTLY COMPATIBLE" WITH ALL DOT MATRIX PRINTERS!
 - * GET "PERFECT CONTROL" OF: HEIGHT, WIDTH, POSITION, BAUD RATE, DOT DENSITY, NEGATIVE IMAGES, ETC.
 - * THE "PERFECT SOLUTION" TO YOUR GRAPHICS PRINTING NEEDS!
 - * COMPATIBLE WITH GRAPHICOM AND COCO MAX PICTURES!
- \$15.00

ONLY \$25.00 ON DISK OR TAPE

SEND CHECK OR MONEY ORDER TO:

HAWKES RESEARCH SERVICES: 859 STANFORD AVE, OAKLAND, CA 94608

*** FOR FREE INFORMATION IN THE MAIL, CALL: (415) 547-7557 ***
YOUR PERSONAL CHECK IS WELCOME! SHIPMENT WITHIN 48 HOURS!
ADD \$3.00 SHIPPING ON ALL ORDERS. CA. RESIDENTS ADD SALES TAX

"I cannot imagine the CoCo 3 without ADOS-3; it would not be a complete machine."

The RAINBOW, July 1987

You've moved up to a CoCo 3. A powerful new machine. Now, it's time to give BASIC a shot in the arm, with ADOS-3. Wouldn't it be nice to turn on your machine and be greeted by an 80-column display, in the colors of your choice, with your own custom startup message? To run routinely at 2 MHz (double speed) without having to slow down for disk and printer operations? This and much, much more is possible with ADOS-3, our CoCo 3 adaptation of the acclaimed original ADOS, which shares the original's virtual 100% compatibility with commercial software. After customizing ADOS-3 using the provided configuring utility, you can have it burned into an EPROM that plugs into the Disk BASIC ROM socket, or just use it in RAM as a disk utility. (EPROM + burning will cost \$15-20; we provide information concerning how you can have this done.) Supports double-sided drives (35, 40, or 80 tracks). FAST and SLOW commands, auto line number prompts, RUNM command, keystroke macros, arrow-key scroll through BASIC programs, auto-edit of error line, and many more valuable features.

"ON A SCALE OF 1 TO 10, I RATE ADOS-3 A SOLID 15." RAINBOW, 7/87
Disk . . . \$34.95 Original ADOS for CoCo 1 or 2 . . . \$27.95 (See 6/87 RAINBOW review)
Original ADOS plus ADOS-3 . . . \$50.00

THE PEEPER

ML program tracer that multitasks with the target program. An excellent learning tool for the ML novice; an invaluable debugging aid for the expert. CoCo 1, 2, or 3 compatible.
Disk . . . \$23.95 Assembler source listing . . . Add \$3.00

MONITOR CABLES for CoCo 3

Magnavox 8CM515/8CM505/8CM643 . . . \$19.95 Sony KV1311CR . . . \$29.95

SPECTROSYSTEMS



11111 N. Kendall Drive,
Suite A108
Miami, Florida 33176
(305) 274-3899 Day or Eve

No delay on personal checks • Please add \$2.00 shipping • Sorry, no credit cards or COD's.

A RAM pack for your CoCo ROM port

Static RAM Interface

By Dennis H. Weide

Last spring, while developing a peripheral control system for disabled persons, I ran into one small obstacle. I had to find a way to load, test and modify a program in Program Pak memory addresses \$C000 through \$FEFF before programming an EPROM chip. So I went to the chalkboard and designed a circuit I thought fit the bill perfectly. It worked so well, in fact, I thought others might find it useful. I call it the Static RAM Interface (SRI for short). It's an excellent hardware project for beginners and, even though it looks complicated, it's easy to build and understand. It works on any version of the CoCo, and I'm sure you'll find scores of uses for it.

Dennis Weide is a communications technician for AT&T in Albuquerque, New Mexico, where he programs AT&T and IBM PCs. He enjoys making toys and teaching programming.

The Solution

It would be nice if we could just hang a few RAM chips on the ROM port and address them in the normal fashion. Unfortunately, there's a problem: Tandy didn't allow the CoCo any means for writing to the ROM port. The CTS lead must go low for both reads and writes to the ROM port. This happens during a ROM read but not during a ROM write. Before we can write to any ROM port memory location, we must find a way to force the CTS lead low during the write cycle.

The solution is simple. Figure 1 is the schematic diagram of a circuit that develops a new CTS lead using address lines A8 through A15. To understand how it works, look at the lowest and highest memory addresses that the ROM port uses and compare them binarily.

Looking at Figure 2, we see the lowest ROM address (\$C000) has only bits 15 and 14 set high. Notice that the highest address (\$FEFF)

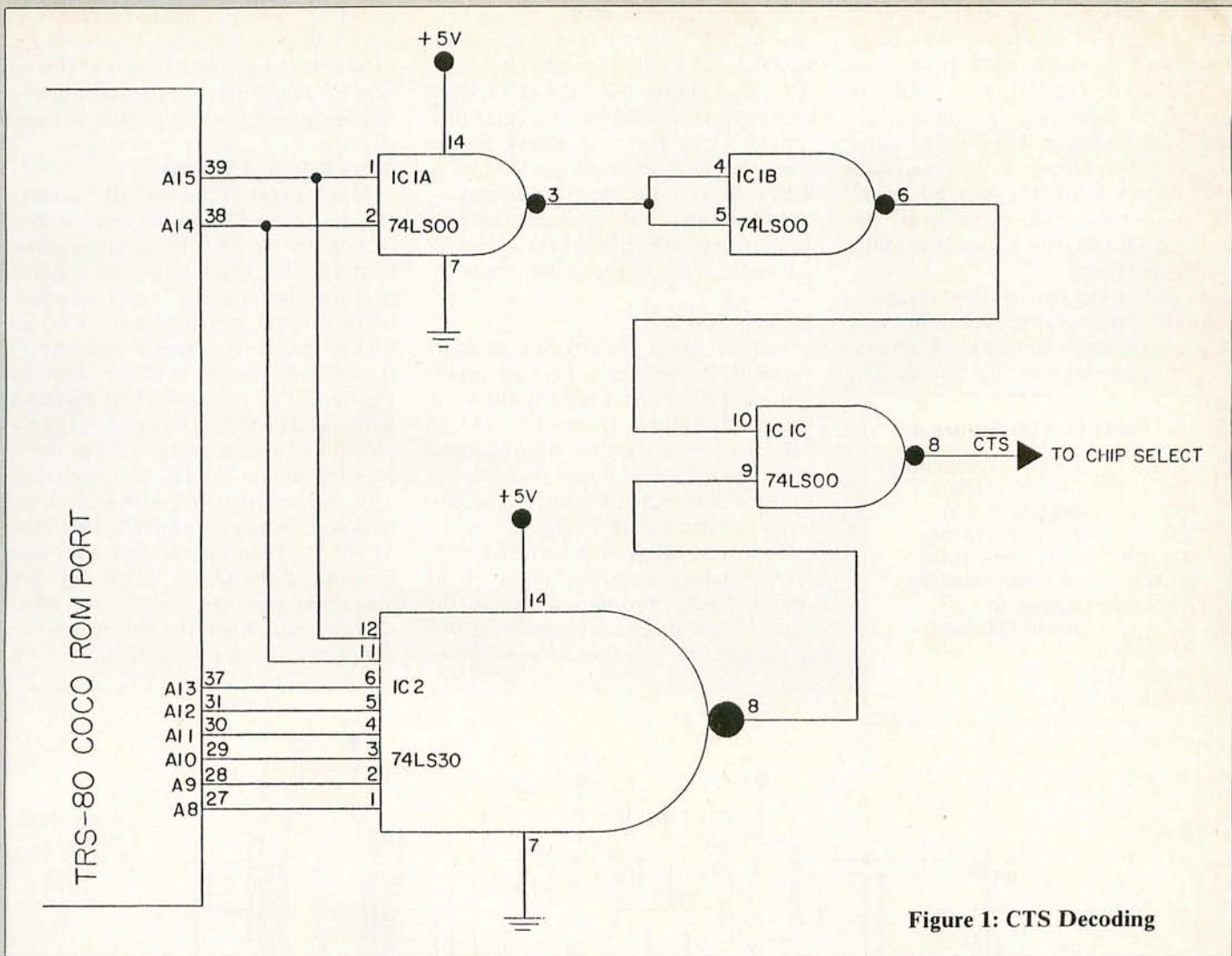

Figure 1: CTS Decoding

also has these same bits set high. Any time we try to access a ROM port address, bits 15 and 14 will be high. In Figure 1, we use these two address bits as inputs to IC1A to select the entire ROM port address range.

In the highest address (\$FEFF), Bit 8 is low. We'll use this bit to determine when we're trying to access an address above the ROM port range.

For a better explanation, refer to Figure 1 again. IC1A (74LS00) is a NAND gate used to determine if bits A15 and A14 are both high. IC1B inverts the output of the previous gate (IC1A) so that we'll have the proper signal state when we need it. If either Bit A15 or Bit A14 is low, the output from IC1B will be low. If both bits are high, the output from IC1B will be high. To get the CTS lead low, both inputs to IC1C must be high. We've seen how to do this for the input on Pin 10. Now let's see how the other input works.

IC2 (74LS30) determines the high cutoff address for us. Any low input (A8 through A15) will cause a high output

on Pin 8. This high is fed to Pin 9 of IC1C. If Pin 10 of this IC is also high (we've seen how to do this), the CTS output on Pin 8 will go low. If all eight inputs to IC2 go high, the output from it will go low and the CTS lead will go high. So, any time we try to access an address above \$FEFF, the CTS lead will go high. This is exactly what we want, because addresses above \$FEFF are outside the ROM port address range. Figure 3 is a truth table for the circuit shown in Figure 1.

Now, the Memory

As you can see, the address decoding for the CTS lead is simple. Well, the rest of the circuit is even more simple. All we do is add two static RAM (SRAM) chips (8K by 8-bit each), a high-low address decoder (74LS138) and three resistors and we're done. We use SRAM instead of dynamic RAM (DRAM) because SRAM doesn't require refreshing or address decoding and can be connected directly to the address and data buses.

LO ADDRESS				
HEX	C	0	0	0
BIN	1100	0000	0000	0000

HI ADDRESS				
HEX	F	E	F	F
BIN	1111	1110	1111	1111

Figure 2: ROM Port Addresses

74LS30			
A15	A14	PIN8	CTS
L	L	L	H
L	L	H	H
L	H	L	H
L	H	H	H
H	L	L	H
H	L	H	H
H	H	L	H
H	H	H	L

FOR 74LS30, ANY LEAD IN LO EQUALS HI OUT, ALL LEADS IN HI EQUALS LO OUT.

Figure 3: CTS Truth Table

Figure 4 shows the entire circuit. Notice that the address and data buses are drawn as single lines to prevent cluttering of the drawing, and are labeled on each chip so you can see where they belong. The SRAM chips are labeled as shown by the manufacturer. When wiring the data bus leads, ROM port leads D0 through D7 are wired to SRAM chip leads D1 through D8, respectively.

As we're using two 8K RAM chips to add 16K of memory, we must find a way to access the new memory in 8K blocks. IC3 in Figure 4 does that for us. For

memory addresses \$C000 to \$DFFF (low 8K), it selects IC5. For addresses \$E000 to \$FEFF (high 8K), it selects IC6. This allows the SRAM to work like any other RAM in the machine. Switch S1 in Figure 4 allows you to select the autoboot feature of the CoCo. When this switch is closed, the computer will automatically execute the program stored in the SRI whenever power is turned on or the computer is reset.

Backup Power

You can make this circuit even more versatile by adding a backup power system. The circuit I used is shown in Figure 5. It uses three AA Ni-Cad batteries to maintain the SRAM memory when the CoCo power switch is off. Resistor R4 limits the current the batteries can draw while charging.

Be sure to charge the batteries completely before installing them in the circuit. Under normal conditions, the batteries will maintain memory for two to three days. This should be no prob-

lem if you use your CoCo every day. If not, you can install a switch between the batteries and ground to allow you to turn off the batteries if the computer is not being used for long periods of time.

More Bells and Whistles

More experienced circuit builders can add a few more bells and whistles to enhance the SRI. If you connect the Q and CART leads of the CoCo ROM port together, the CoCo will automatically execute any program stored in SRI memory every time the reset button is pushed or the power is turned on. In Figure 6, I've replaced S1 of Figure 4 with a double-pole/double-throw switch and added green and red light-emitting diodes (LEDs) to the circuit. This gives a visual "auto EXEC/norm" indicator. When the switch is set to the AUTOEXEC ON position, the CART and Q leads of the CoCo ROM port are connected together and the red LED will light up. When the switch is set to the AUTOEXEC OFF position, the CART

Parts List for Figure 4

C1-C5	0.1 MFD Capacitors
IC1	74LS00 (7400)
IC2	74LS30 (7430)
IC3	74LS138 (74138)
IC4, IC5	2064 Static RAM
R1-R3	1K OHM 1/4W 5%
ROM Port Connector	JE413 (Jameco)

Perfboard
30 GA. Wire
Wirewrap Sockets

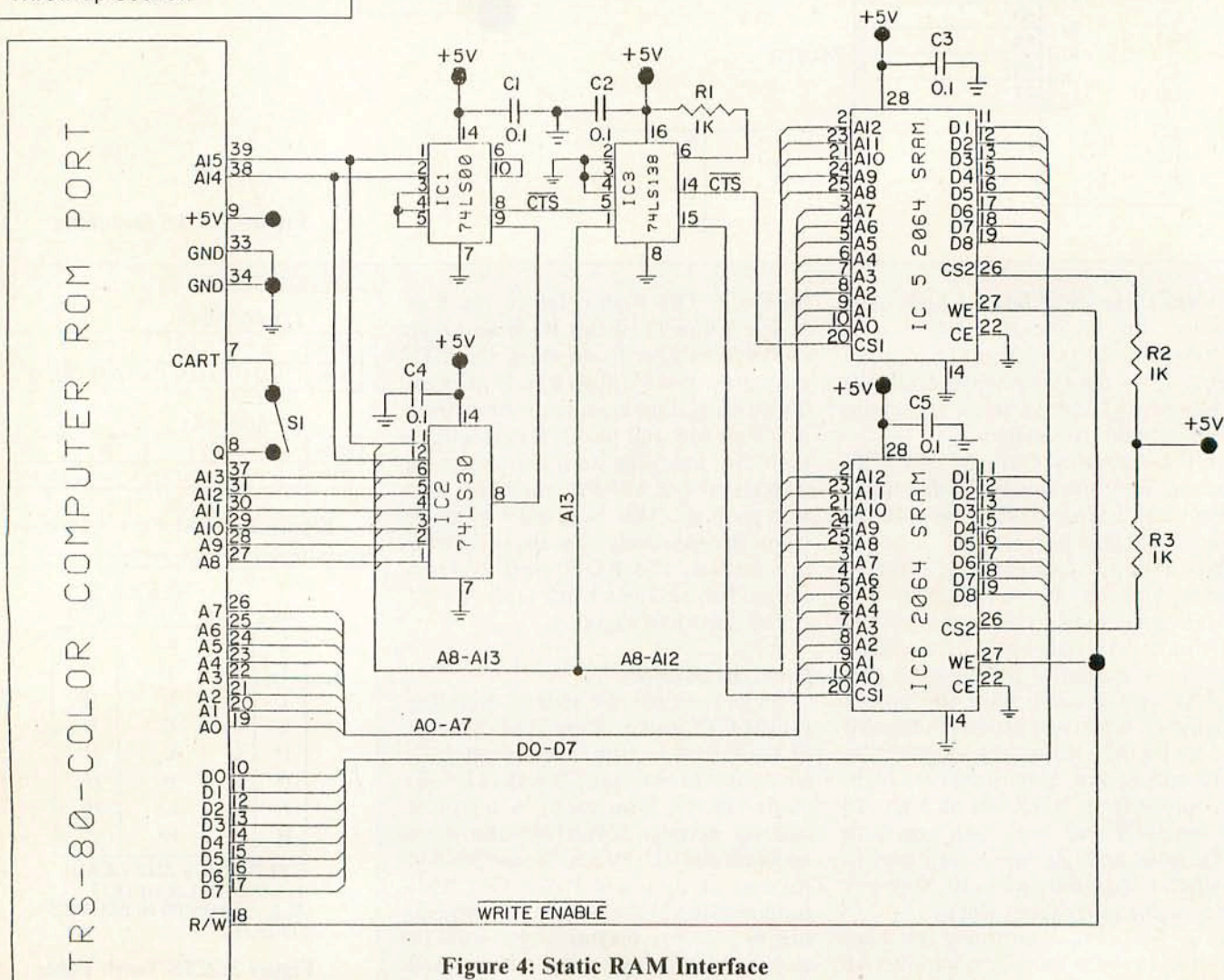

Figure 4: Static RAM Interface

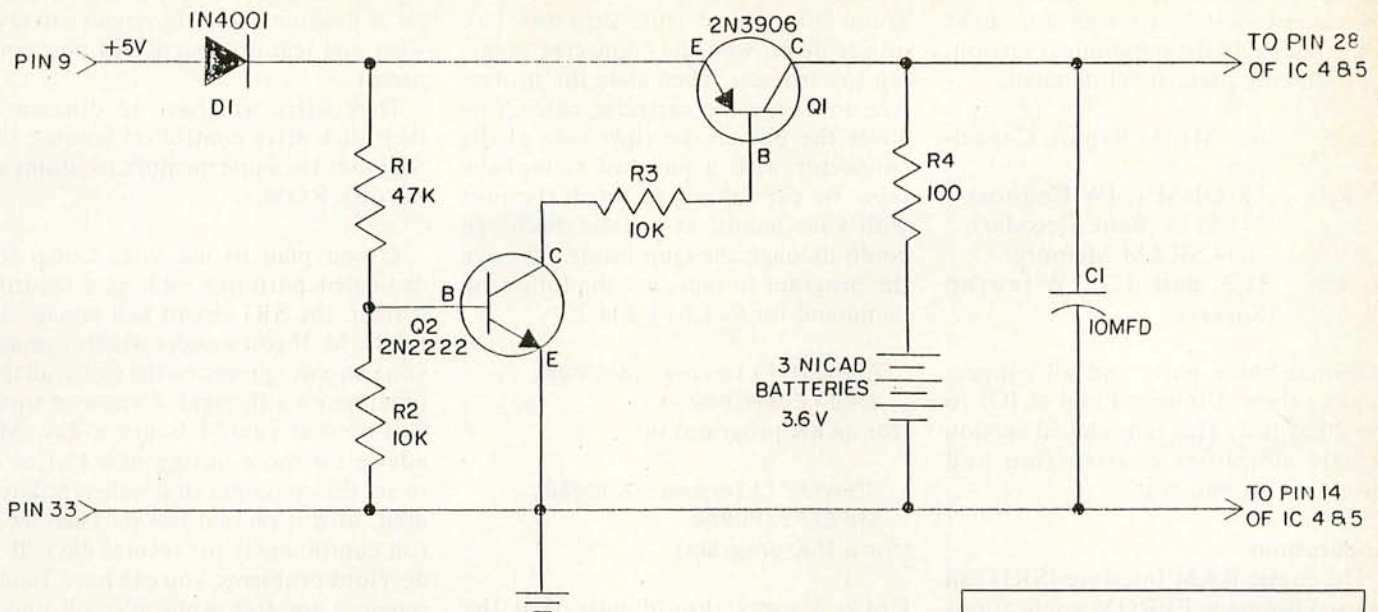

Figure 5: Backup Battery Circuit

Parts List for Figure 5

- C1 10MFD 10 Volt Elect
- D1 1N4001 Diode
- Q1 2N3906 PNP TRANS
- Q2 2N2222 NPN TRANS
- R1 47K OHMS 1/4W 5%
- R2,R3 10K OHMS 1/4W 5%
- R4 100 OHMS 1/4W 5%
- Nicads 3 "AA" Nicad Cells

Parts are available from your local Radio Shack or from Jameco Electronics, 1355 Shoreway Road, Belmont, CA 94002, (415)592-8097

and Q leads are not connected, and the green LED lights up. Note that to automatically execute a program stored in SRI memory on power-up, you must use a backup battery circuit similar to that in Figure 5. Otherwise, you'll be executing garbage and the computer may lock up. This won't hurt the CoCo, though — it's just convenient.

You can add write protection to the circuit by holding the WE (write enable) lead of IC5 and IC6 high. Figure 7 shows how to add a write protect switch and indicator to the write enable lead of Figure 4. The write enable lead must be low to write to IC5 or IC6. When Switch S2 is set to the WR ENABLE position, the R/W lead from the CoCo ROM port is connected directly to the write enable leads of IC5 and IC6, and the red LED lights up. When the switch is set to the WR PROT position, the write enable leads of IC5 and IC6 are permanently

held high by the 2.2K ohm resistor, and the green LED lights. This prevents accidentally overwriting any program stored in the SRI memory.

Construction

Construction is not critical, but it can be made easy if you wire wrap. I located one SRI board inside the computer beneath the keyboard. If you decide to do this, plan carefully. There's enough room beneath the keyboard on all versions of the CoCo, but the amount of space varies from version to version. I used a Vector board (#JE413) from Jameco Electronics for the cartridge connector. It will be necessary to cut the pin end to fit the ROM port, because the board is a 44-pin card edge connector; the ROM port uses only 40 pins. Keep all leads as short as possible, and be sure to include capacitors C1 through C5 to prevent switching tran-

sients from causing problems. Check all wiring visually *and* with a continuity checker before plugging in to the ROM port or applying power to the circuit. Also, note that opening the CoCo case voids any warranty you may have on the computer.

An Economical Version

For those who want to economize, you can build a cheaper version using

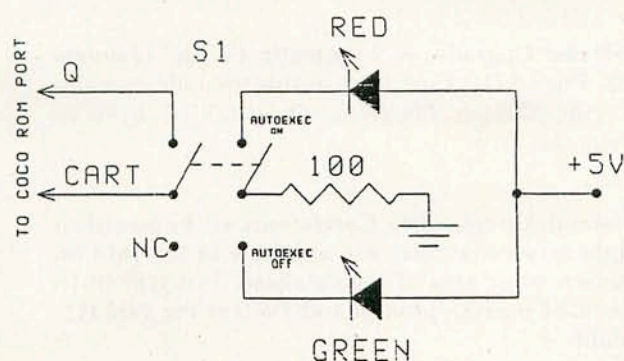

Figure 6: Auto Execute LED Indicator

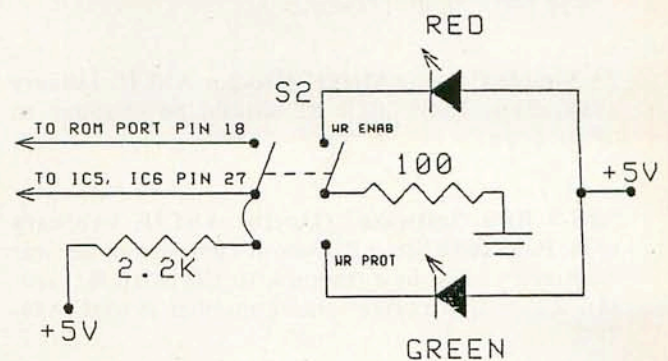

Figure 7: Write Protect LED Indicator

only one SRAM. This will give you an 8K circuit that is enough for most applications. In the economical version, the following parts are eliminated:

C2,C5	0.1 MFD. Bypass Capacitors
R1,R3	1K OHM 1/4W Resistors
IC3	74LS138 (Bank Decoder)
IC5	2064 SRAM Memory
Sockets	IC3 and IC5 Wirewrap Sockets

Eliminate these parts and all connections to them. Connect Pin 8 of IC1 to Pin 20 of IC5. This economical version greatly simplifies construction and lowers the overall cost.

Applications

The Static RAM Interface (SRI) can be used for many EPROM applications in the CoCo 1, 2 and 3. In addition, it can be used to modify programs on Program Paks or other ROMs. I found the SRI so useful that I decided not to build an EPROM programmer after all.

For cassette systems, you can save and load Program Pak programs to and from tape by following these easy steps. First, it's important to disable the

automatic execute feature of the Program Pak. To do this, turn the Pak upside down with the connector pointing toward you. Then slide the protective door into the cartridge case. Now cover the pin on the right side of the connector with a piece of cellophane tape. Be careful not to touch the pins with your hands, as a static discharge could damage the chip inside. To save the program to tape, use the following command for CoCos 1 and 2:

```
CSAVEM"filename",&HC000,
&H0FFF,&HC000
(for an 8K program) or
```

```
CSAVEM"filename",&HC000,
&HFEFF,&HC000
(for a 16K program).
```

CoCo 3 users should note that the correct EXEC address for Program Paks in the CoCo 3 is \$E010, not \$C000.

After you verify the files with the SKIPF command, you can execute them from the SRI memory. First, turn off the computer and plug in the SRI memory board. Turn the power on and set switch 1 to the WRITE position. You can now load the programs saved on

tape in the usual method. If you use a lot of Program Paks, the circuit will save wear and tear on your ROM port connector.

Disk users will have to disconnect their disk drive controllers because the SRI uses the same memory locations as the disk ROM.

If you plan to use your CoCo for dedicated purposes such as a security system, the SRI circuit can replace an EPROM. If you wonder whether or not you can leave power on the CoCo all the time, here's a thought. I know of three CoCos that run 24 hours a day. My advice for those buying new CoCos is to set the computer in a well-ventilated area, turn it on and test it. Then let it run continuously for several days. If it develops problems, you can have Tandy repair it for free while it's still under warranty. Once your new CoCo passes the "soak" test, you'll find it's pretty reliable.

(Questions or comments regarding this project may be directed to the author at 14201 Marquette N.E., Albuquerque, NM 87123. Please enclose an SASE if you are writing for a reply.) ☺

Corrections

"Address — Computer Address Book" (Review, March 1988, Page 132): The review of *Address* was incorrectly flagged for the CoCo 1, 2 and 3. Actually, *Address* works only on the CoCo 3.

"Disk EDTASM on CoCo 3" (Doctor ASCII, January 1988, Page 154): The listing, PATCH, is missing the following line:

```
610 DATA "END", "END".
```

"A Simple Cassette Merge" (Doctor ASCII, January 1988, Page 154): OPEN #1 should be changed to OPEN "I", #1.

"OS-9 BBS Software" (Doctor ASCII, February 1988, Page 168): Steve Roberson's phone number was incorrectly listed in a response to Christian B. Lutz. Mr. Roberson's correct phone number is (602) 844-7840.

"Poke Monochrome Fix" (Doctor ASCII, January 1988, Page 154): POKE &HEE066,16 should be changed to POKE &HE066.

"Received and Certified" (April 1988, Page 140): The program listed as *Systems* should be *System 5*. Also, the program requires 512K, not 128K, as stated. *Elec-Soft, 803d W. 47th Street, Norfolk, VA 23508; 804-451-1255.*

"Solitaire Upgrade — Automatic Finish" (January 1988, Page 171): Line 1360 in this upgrade contains an error. Change COL(F,I)=0 to COL(F,1)=0 to correct this error.

For quicker reference, Corrections will be posted on Delphi as soon as they are available in the Info on Rainbow topic area of the database. Just type DATA at the CoCo SIG> prompt and INFO at the TOPIC> prompt.



PMODE 4 HPRINT
By: Douglas Pokorny

**Will print any HPRINT font on
 the PMODE 4 graphics screen
 without a single DRAW statement
 High resolution 32x24 screen
 with complete I.B.M. Character
 set, that may also be used in
 HSCREEN 1,2,3 or 4 without
 a special driver program**

Adding the HPRINT Capability to PMODE 4

By Douglas Pokorny

Those of you who have not yet upgraded to a CoCo 3 might feel that your computer is limited in graphics capabilities. Until now, if you wanted to print on the graphics screen, you either had to use a lot of DRAW statements, write a machine language program, or buy a CoCo 3.

I can help change that. The program presented here adds the HPRINT capability to PMODE 4 on any CoCo that has 64K or more memory. My HPRINT subroutine is 10 lines of BASIC code that call font patterns from high memory. These font patterns, strangely enough, come directly from that little area of memory set aside for the HPRINT font. This simply means that any CoCo 3 font you have loaded into memory can be printed on the PMODE 4 graphics screen. Knowing that most CoCo 1 and 2

Douglas Pokorny attends Glenbard South High School in Glen Ellyn, Illinois, where he is a member of the Glenside CoCo Club. He is the co-author of BSE, a screen editor distributed by Howard Medical Computers.

owners won't have a lot of CoCo 3 fonts lying around handy to load in, I have included one. It is almost a 100 percent look-alike of the very popular font used by PC clones. The only drawback is that it may be a few data lines too long for the average CoCo user to type in.

Loading the Demo Program

If you are a CoCo 3 user, you simply need to type in the BASIC driver program FONTDEMO and run it; you need not type in the FONTPOKE program. You may wish to load your own font before running this program, or use the data program to create one for you.

If you are using a CoCo 1 or 2, you have a typing lesson ahead. First type in the program FONTDEMO and save it. (If you, for some strange reason, have a CoCo 3 font handy, then skip the next part.) Type in the program FONTPOKE, save and run it. This will create an ML file called IBM.FNT that is used by FONTDEMO. The third program to type is a simple program to transfer ROM to RAM so that you may load in the font IBM.FNT without using any of your

cramped program memory. When you have those three programs saved and have run FONTPOKE, you should have four files on your disk. RAINBOW ON DISK users will need to copy the files to a fresh disk *before* running FONTPOKE.

When the cursor reappears, begin by running ROMRAM, and then run the program FONTDEMO. It in turn will load the file IBM.FNT and start printing on the PMODE 4 graphics screen.

Using the Program

The print program works entirely on an x,y coordinate system, much like the CoCo 3's LOCATE command or the HPRINT (X,Y) command. It does not feature true wraparound, so be careful when printing so that your text does not exceed the screen width. To make it compatible with the HPRINT font, I designed the program to use an 8-by-8 pixel block for each character. This means that there is a screen resolution of 32 columns by 24 lines. The only thing that can possibly be limiting is that the character positions, like the text screen, are fixed. For example, you

cannot specify that you would like this character A exactly 25 pixels over from that box drawn over there. Unless that box just happens to be 25 pixels from a character position, you're out of luck. But not totally. After printing your text you can use GET and PUT to move it anywhere. Although it's a more complicated procedure, you will find centering text easier than if you use a pixel-by-pixel or PRINT @ technique.

To use this program you must simply give it the values of three variables and GOSUB to the basic code. The average program will look like this:

```
10 X=0: Y=5: A$="I really
like PMODE 4 HPRINT!!"
20 GOSUB 10000
10000 'HPRINT ROUTINE
-Subroutine program-
10010 RETURN
```

In this program, you set the x and y coordinates as X= x location, Y= y location, and A\$="Text to print" followed by a GOSUB 10000, the location of FONTDEMO's "HPRINT" code. Use the same subroutine in your program where you want to print. After printing the message, it will return to where you left off in your program. The parameters are: X= 0 to 31 for 32 columns and Y= 0 to 23 for 24 rows, and A\$= any printable text characters from

CHR\$(32) to CHR\$(127). This consists of all alphabetic characters, all numbers, punctuation, special characters, and the following not normally producible in Extended Color BASIC on the CoCo 2: A single "back quote" (looks like an apostrophe (') but is reversed), curly braces ({} and {}), and an underline character (like the one used as the width 40/80 cursor).

The following are for use in *Teletwriter-80* (Cognitec & Doug Masten): An end-of-text file marker (a diagonally striped square), a carriage return (an arrow pointing down and to the left) and an underline delimiter (a double underline).

Additional Programming Tips

The program is preset to print black characters on a white background in SCREEN 1,1 and black characters on green in SCREEN 1,0. This is actually the *inverse* of what would normally be printed. BASIC is set up to print green or white characters on a black background, but I found that black on white or green looks better on my monitor. To change from this inverse mode to normal, simply find the line in the subroutine with the POKE command in it. It looks something like this:

```
POKE A+32*D,255-PEEK
(&HF09D+C+D).
```

Change it to:

```
POKE A+32*D,PEEK (&HF09D+C+D).
```

If you own a CoCo 3, there is a scientific character set available with no extra typing. In the line mentioned above, change the PEEK location to &HFA0F and a new, previously "hidden" character set will be displayed in place of the regular font. The new font consists of scientific, alternative language, and graphics blocks. This feature is not offered to CoCo 2 users. I don't know why this font isn't offered in BASIC, but it's there for your use.

ROM/RAM

As you know, the CoCo 3 does an automatic ROM/RAM on power-up. The CoCo 1 and 2 do not feature this, because this program uses space above &H7FFF. CoCo 1 and 2 users must first run the ROMRAM utility shown in Listing 3 to put the machine in the 64K mode and allow changes to ROM.

(Questions or comments regarding these programs may be addressed to the author at 932 Oakwood Ct., Glen Ellyn, IL 60137. Please enclose a SASE when requesting a reply.) □

Listing 1: FONTDEMO

```
10 ' A BASIC ROUTINE TO USE
      HPRINT FONTS IN WIDTH 32
20 LOADM"IBM.FNT"
30 PMODE4,1:SCREEN1,1:PCLS1
40 X=9:Y=0:A$="PMODE 4 HPRINT"
50 GOSUB 100000
60 X=6:Y=1:A$="By: Douglas Poko
rny"
70 GOSUB 100000
80 X=1:Y=3:A$="Will print any HP
RINT font on"
90 GOSUB 100000
100 X=2:Y=5:A$="the PMODE 4 grap
hics screen"
110 GOSUB 100000
120 X=0:Y=7:A$="without a single
DRAW statement"
130 GOSUB 100000
140 X=2:Y=9:A$="High resolution
32x24 screen"
150 GOSUB 100000
160 X=1:Y=11:A$="with complete I
.B.M. Character"
170 GOSUB100000
180 X=1:Y=13:A$="set, that may a
lso be used in"
190 GOSUB 100000
200 X=3:Y=15:A$="HSCREEN 1,2,3 o
r 4 without"
210 GOSUB 100000
220 X=4:Y=17:A$="a special drive
r program"
230 GOSUB 100000
240 GOTO 240
100000 IF X<0 OR X>31 OR Y<0 OR Y
>23 THEN PRINT"?FC ERROR":END
100001 A=256*Y+X+3584
100002 FOR B=1 TO LEN(A$)
100003 B$=MID$(A$,B,1)
100004 C=(ASC(B$)-32)*8
100005 FOR D=0 TO 7
100006 POKE A+32*D,255-PEEK(&HF09
D+C+D)
100007 NEXT D
100008 A=A+1
100009 NEXT B
100100 RETURN
```

Listing 2: FONTPOKE

```

1Ø DATA Ø,Ø,Ø,Ø,Ø,Ø,Ø,Ø
2Ø DATA 3Ø,78,78,3Ø,3Ø,Ø,3Ø,Ø
3Ø DATA 6C,6C,6C,Ø,Ø,Ø,Ø,Ø
4Ø DATA 6C,6C,FE,6C,FE,6C,6C,Ø
5Ø DATA 3Ø,7C,CØ,78,C,F8,3Ø,Ø
6Ø DATA Ø,C6,CC,18,3Ø,66,C6,Ø
7Ø DATA 38,6C,38,76,DC,CC,76,Ø
8Ø DATA 3Ø,3Ø,6Ø,Ø,Ø,Ø,Ø,Ø
9Ø DATA 18,3Ø,6Ø,6Ø,6Ø,3Ø,18,Ø
1ØØ DATA 6Ø,3Ø,18,18,18,3Ø,6Ø,Ø
11Ø DATA Ø,66,3C,FF,3C,66,Ø,Ø
12Ø DATA Ø,3Ø,3Ø,FC,3Ø,3Ø,Ø,Ø
13Ø DATA Ø,Ø,Ø,Ø,Ø,3Ø,3Ø,6Ø
14Ø DATA Ø,Ø,Ø,FF,Ø,Ø,Ø,Ø
15Ø DATA Ø,Ø,Ø,Ø,Ø,3Ø,3Ø,Ø
16Ø DATA 6,C,18,3Ø,6Ø,CØ,8Ø,Ø
17Ø DATA 7C,C6,CE,DE,F6,E6,7C,Ø
18Ø DATA 3Ø,7Ø,3Ø,3Ø,3Ø,3Ø,78,Ø
19Ø DATA 78,CC,C,38,6Ø,C4,FC,Ø
2ØØ DATA 78,CC,C,18,C,CC,78,Ø
21Ø DATA 1C,3C,6C,CC,FE,C,1E,Ø
22Ø DATA FC,CØ,F8,C,C,CC,78,Ø
23Ø DATA 38,6Ø,CØ,F8,CC,CC,78,Ø
24Ø DATA FC,CC,C,18,3Ø,3Ø,3Ø,Ø
25Ø DATA 78,CC,CC,78,CC,CC,78,Ø
26Ø DATA 78,CC,CC,7C,C,18,7Ø,Ø
27Ø DATA Ø,3Ø,3Ø,Ø,Ø,3Ø,3Ø,Ø
28Ø DATA Ø,3Ø,3Ø,Ø,Ø,3Ø,3Ø,6Ø
29Ø DATA 18,3Ø,6Ø,CØ,6Ø,3Ø,18,Ø
3ØØ DATA Ø,Ø,FE,Ø,Ø,FE,Ø,Ø
31Ø DATA 3Ø,18,C,6,C,18,3Ø,Ø
32Ø DATA 78,CC,C,18,3Ø,Ø,3Ø,Ø
33Ø DATA 7C,C6,CE,DA,CE,CØ,7E,Ø
34Ø DATA 3Ø,78,CC,CC,FC,CC,CC,Ø
35Ø DATA FC,66,66,7C,66,66,FC,Ø
36Ø DATA 3C,66,CØ,CØ,CØ,66,3C,Ø
37Ø DATA F8,6C,66,66,66,6C,F8,Ø
38Ø DATA FE,62,68,78,68,62,FE,Ø
39Ø DATA FE,62,68,78,68,6Ø,FØ,Ø
4ØØ DATA 3C,66,CØ,CØ,CE,66,3E,Ø
41Ø DATA CC,CC,CC,FC,CC,CC,CC,Ø
42Ø DATA 78,3Ø,3Ø,3Ø,3Ø,3Ø,78,Ø
43Ø DATA 1E,C,C,C,CC,CC,78,Ø
44Ø DATA E6,66,6C,78,6C,66,E6,Ø
45Ø DATA FØ,6Ø,6Ø,6Ø,62,66,FE,Ø
46Ø DATA C6,EE,FE,FE,D6,C6,C6,Ø
47Ø DATA C6,E6,F6,DE,CE,C6,C6,Ø
48Ø DATA 38,6C,C6,C6,C6,6C,38,Ø
49Ø DATA FC,66,66,7C,6Ø,6Ø,FØ,Ø
5ØØ DATA 78,CC,CC,CC,CC,DC,78,1C
51Ø DATA FC,66,66,7C,6C,66,E6,Ø
52Ø DATA 78,CC,EØ,78,1C,CC,78,Ø
53Ø DATA FC,B4,3Ø,3Ø,3Ø,3Ø,78,Ø
54Ø DATA CC,CC,CC,CC,CC,CC,78,Ø
55Ø DATA CC,CC,CC,CC,CC,78,3Ø,Ø
56Ø DATA C6,C6,C6,D6,FE,EE,C6,Ø
57Ø DATA C6,C6,6C,38,38,6C,C6,Ø
58Ø DATA CC,CC,CC,78,3Ø,3Ø,78,Ø
59Ø DATA FE,C6,8C,18,32,66,FE,Ø

```

```

6ØØ DATA 78,6Ø,6Ø,6Ø,6Ø,6Ø,78,Ø
61Ø DATA CØ,6Ø,3Ø,18,C,6,2,Ø
62Ø DATA 78,18,18,18,18,18,78,Ø
63Ø DATA 1Ø,38,6C,C6,Ø,Ø,Ø,Ø
64Ø DATA Ø,Ø,Ø,Ø,Ø,Ø,Ø,FF
65Ø DATA 3Ø,3Ø,18,Ø,Ø,Ø,Ø,Ø
66Ø DATA Ø,Ø,78,C,7C,CC,76,Ø
67Ø DATA EØ,6Ø,6Ø,7C,66,66,DC,Ø
68Ø DATA Ø,Ø,78,CC,CØ,CC,78,Ø
69Ø DATA 1C,C,C,7C,CC,CC,76,Ø
7ØØ DATA Ø,Ø,78,CC,FC,CØ,78,Ø
71Ø DATA 38,6C,6Ø,FØ,6Ø,6Ø,FØ,Ø
72Ø DATA Ø,Ø,76,CC,CC,7C,C,F8
73Ø DATA EØ,6Ø,6C,76,66,66,E6,Ø
74Ø DATA 3Ø,Ø,7Ø,3Ø,3Ø,3Ø,78,Ø
75Ø DATA C,Ø,C,C,C,CC,CC,78
76Ø DATA EØ,6Ø,66,6C,78,6C,E6,Ø
77Ø DATA 7Ø,3Ø,3Ø,3Ø,3Ø,3Ø,78,Ø
78Ø DATA Ø,Ø,CC,FE,FE,D6,C6,Ø
79Ø DATA Ø,Ø,F8,CC,CC,CC,CC,Ø
8ØØ DATA Ø,Ø,78,CC,CC,CC,78,Ø
81Ø DATA Ø,Ø,FC,66,66,7C,6Ø,FØ
82Ø DATA Ø,Ø,76,CC,CC,7C,C,1E
83Ø DATA Ø,Ø,DC,76,66,6Ø,FØ,Ø
84Ø DATA Ø,Ø,7C,CØ,78,C,F8,Ø
85Ø DATA 1Ø,3Ø,7C,3Ø,3Ø,34,18,Ø
86Ø DATA Ø,Ø,CC,CC,CC,CC,76,Ø
87Ø DATA Ø,Ø,CC,CC,CC,78,3Ø,Ø
88Ø DATA Ø,Ø,C6,D6,FE,FE,6C,Ø
89Ø DATA Ø,Ø,C6,6C,38,6C,C6,Ø
9ØØ DATA Ø,Ø,CC,CC,CC,7C,C,F8
91Ø DATA Ø,Ø,FC,18,3Ø,6Ø,FC,Ø
92Ø DATA C,18,18,3Ø,18,18,C,Ø
93Ø DATA 66,33,99,CC,66,33,99,CC
94Ø DATA 3Ø,18,18,C,18,18,3Ø,Ø
95Ø DATA 6,26,66,FE,FE,6Ø,2Ø,Ø
96Ø DATA Ø,Ø,Ø,Ø,Ø,7E,7E,Ø
97Ø FOR X=&HFØ9D TO &HF396
98Ø READ A$
99Ø A=VAL("&H"+A$)
1ØØØ POKE X,A
1Ø1Ø NEXT X
1Ø2Ø SAVEM"IBM.FNT",&HFØ9D,&HF39
6,Ø

```

Listing 3: ROMRAM

```

1Ø 'ROMRAM 8/85 RAINBOW
2Ø CLEAR 999
3Ø DATA 26,8Ø,19Ø,128,Ø,183,255,
222,166,128
4Ø DATA 183,255,223,167,31,14Ø,2
24,Ø,37,241,57
5Ø FOR I=1TO21:READA:A$=A$+CHR$(
A):NEXT I
6Ø P=VARPTR(A$)+1
7Ø POKE P,126
8Ø EXEC P
9Ø PRINT "BASIC IS NOW IN RAM"

```

In this and in future "CoCo Consultations," I will be trying something new. In addition to the familiar Q & A column, I will also include tidbits of information contributed by various folks and, in some cases, comment on the information. Thus, even if you don't have a question, I invite you to send in any little hints or descriptions of experiences you have had with the CoCo that you think might be of interest to the CoCo-owning public in general.

I have a disk controller that provides for two different disk ROMs, with a switch to toggle between them. I have a ROM in one socket and none in the other. What would happen if I were to switch to the blank socket while the power is on? What would happen if I had a second disk ROM of some kind in the other socket, and then made the switch?

Andrew James
(ANDREWJAMES)
Nashua, NH

The result would be different in either case depending on whether you have a CoCo 3 or a CoCo 1 or 2. With the CoCo 3, the contents of the disk ROM is moved into RAM and then patched at the instant of power up. After that, the CoCo 3 runs entirely out of RAM memory. It never again looks at the ROM in normal BASIC operation, nor during the operation of many (though not all) commercial programs for the CoCo. Thus, on a CoCo 3, making the switch to another socket should make no difference whatsoever after the first second or so of power up. Note that the

Martin H. Goodman, M.D., a physician trained in anesthesiology, is a longtime electronics tinkerer and outspoken commentator — sort of the Howard Cosell of the CoCo world. On Delphi, Marty is the SIGop of RAINBOW's CoCo SIG and database manager of OS-9 Online. His non-computer passions include running, mountaineering and outdoor photography. Marty lives in San Pablo, California.

Just what the Doctor ordered

For All the ROM Reasons

By Marty Goodman
Rainbow Contributing Editor

ROM is recopied if you do a full cold start (hold down CTRL and ALT keys, press reset, then press reset again). If you switched to a blank socket, then did a full cold start, your computer would come up with Extended Color BASIC, for it would have lost sight of the disk ROM during the cold start/power up process.

On a CoCo 1 or 2, the situation is a bit different. CoCos 1 and 2 normally "run out of ROM" all the time and thus are constantly executing code that resides in the ROM. In particular, there is an "interrupt routine" in Disk BASIC that is executed 60 times a second. If you switch to a blank ROM socket on such a machine, the computer will immediately crash because you have "pulled the rug out from under" its operating code. That is, you will have removed from its "sight" the code it needs to execute 60 times a second.

If you have a different disk ROM in the second socket, things get a bit more complex and subtle. The results depend on three things: the similarity of the two disk ROMs, the physical properties of the switch on the controller, and exactly when you switch it. Two fundamentally similar ROMs, such as Disk BASIC 1.0 and ADOS 2, usually can be switched during normal BASIC operation with no problem. However, about one time in 10, making that switch causes the computer to lock up: This happens if you manage to be turning the switch at the exact time the interrupt code is being

executed, when the switch is between positions during the execution of that code. This results in a situation similar to the one above of switching to a blank ROM socket. In general, though, it is a poor idea to switch between disk ROMs while the computer is in BASIC or when it's executing other code. You should always turn the power off (or, on a CoCo 3, do a full cold start as described above) after switching ROMs.

VIP Speller on the CoCo 3

Is there a patch for VIP Speller to make it work on the CoCo 3?

Paul McCay
(PAULMCCAY)
Manchester, NH

Because there were many different versions of the VIP products released, it is rather difficult for anyone to write a patch that works for all versions. I know of no such patch in the public domain. But S&D Enterprises (P.O. Box 1233, Gresham, OR 97030) is currently selling a CoCo 3 compatible version of *VIP Speller* for \$35. For \$80 they have listed *VIP Writer III*, a version of *VIP Writer* that utilizes the full 80-column text screen capabilities of the CoCo 3.

Clean Screen

I bought a used Amdek monochrome monitor, the screen of which seemed marred, as if it were scratched. I noticed there was an anti-glare screen up against the picture tube. Despite your warning to me on Delphi about the dangers of messing with this arrangement, I took the monitor apart, and found that the anti-glare screen easily came off the picture tube. The defect turned out to be a buildup of dirt between the anti-glare mesh and the picture tube itself. I washed both the anti-glare mesh and the picture tube using warm, soapy water, rinsed them with water, then put it all back together. The result: My monitor now looks like new, and the blemish is completely gone.

Alex Volpe
(NIGHTAL)
Plymouth Meeting, PA

Thanks much, Alex, for that tip. Amdek 300 series monitors have one of the finest, most glare-free images I've

ever seen. Not everyone has your luck with used monitors, though. Sometimes the problems can be more severe. The anti-glare mesh itself can be *tor*n. In such cases, repair is more difficult, though it may be possible to order a replacement anti-glare mesh from Amdek. Note that the Amdek 300 series uses a monochrome composite video input (compatible with CoCo 3), but the Amdek 310 series uses a TTL monochrome input (for use only with IBM monochrome systems).

Vestigial Remains

I noticed that Pin 10 on the CoCo 3's RGB connector is pulled to +5 volts through a 4.7K ohm resistor and also runs to Pin 13 of the 68B21 PIA (Bit 3 of \$FF22). What function is this pin supposed to serve? Does shorting that pin to ground cause the CoCo 3 to recognize the presence of the RGB monitor and reset the palette accordingly, or set to 80-column width, or what?

Paul Pollock
(PAULBELL)
Sepulveda, CA

You have discovered a "vestigial" feature on the CoCo 3, which is *not* documented and is *not* officially used. There is *no* code in BASIC, OS-9 or any commercial software I know of that looks for the status of that PIA port bit. My speculation is that at one stage of CoCo 3's design, the design team, as you guessed, considered putting a hardware indicator that could be tied to ground to show the presence of an RGB monitor on that 10-pin port.

Fortunately (in my opinion), they abandoned that idea. It would have been a mistake, for many users (like myself) use both monochrome and RGB monitors (or both RGB and composite color video monitors) on their CoCo 3s at the same time. If software were to automatically set up for RGB palette any time it saw a plug in the RGB connector, folks like us might be greatly inconvenienced. It seems, however, that they abandoned the idea *after* the printed circuit board for the CoCo 3 had been laid out, or possibly after it was already in production. So the hardware provision for such a feature remained, despite the decision to abandon software support for this feature.

Note that even Tandy's CM8 does not pull Pin 10 to ground. It simply does not use that line, which is probably the most compelling evidence of all that Tandy

itself has decided not to use that provision.

To this day, Pin 10 of the CoCo 3 RGB video connector provides a single-bit input to the PIA port at \$FF22, which is normally tied high. Die-hard hackers might find some use or other for that input. For me, the most sensible use for Pin 10 is to disconnect it from its current circuit (by removing R61 and R62, both 4.7K resistors located near the 68B21 PIA) on the board. Then hook either 5 volts or a combined negative sync to that pin to allow the RGB port to be used more flexibly with other brands of RGB analog monitors.

Combined negative sync can easily be generated using a 74LS02 chip you can piggy-back onto the 74LS04 that is currently used as a sync buffer for the separate H and V sync. Putting that on Pin 10 will make it trivial to use the CoCo 3 with Sony and Amiga-type RGB analog monitors, providing there is a proper cable; having +5 volts on Pin 10 means you can put the needed sync combiner and inverter circuitry easily into the cable, allowing even greater flexibility, though causing greater complexity of cable design.

Vertical Resolution

Is there any hardware modification — of any complexity — that allows more vertical lines and/or allows for the use of interlace (as on the Amiga) on the Color Computer 3? Does the upgraded GIME chip support more vertical lines per inch than the old one, even if only in monochrome?

Christopher M. Webster
Shermansdale, PA

The answer to all your questions is one big no. The CoCo was designed around monitors that accept horizontal scan frequencies of 15.75 KHz. This limits it to 200 to 225 lines of vertical resolution. To get more than that would require the use of multiscan monitors, which cost about \$1,000 when the CoCo 3 was being designed, and still cost in excess of \$500 today. It would have been sheer madness on any designer's part to make a \$200 computer that required a \$1,000 monitor to get full graphics display! Even if hardware support for such a monitor had been provided, no software developer in his right mind would consider taking the time to write software for it, considering how few CoCo owners would be buying one.

The new GIME chip is basically the same as the old one, with a few very

minor bugs corrected. As for interlace, again, no. There is no way to modify the CoCo to use that, short of completely rebuilding and redesigning the computer pretty much from the ground up.

If you want greater vertical resolution, I suggest you look into the Macintosh II or a Sun workstation. You might also consider an 80386 MS-DOS/OS2 machine with VGA adapter. Any of these systems will set you back \$5,000 to \$20,000, depending on configuration. The Amiga, which uses interlace in its highest vertical resolution mode, suffers from flicker problems. Indeed, most color graphics programs for it wisely elect to use no more than 200 to 225 lines of vertical resolution, turning off the interlace feature to avoid this problem.

BASIC Enhancements

Can the CoCo 3 be made to power up to a 40-column screen?

John N. Lim, Jr.
(NAHALEA)
Mililani, HI

See pg 149

Yes. By using ADOS-3, you can configure and burn an alternate DOS EPROM that will cause the CoCo 3 to power up in 40 or 80 columns in any color set you choose. ADOS-3 also enhances BASIC in many other ways, including adding a full-screen editor and fixing BASIC for proper disk operation at double speed. I highly recommend it. It is available from Spectro-Systems. When you buy the product you get a *software* product, which, for an additional fee, you may send out to have burned into an EPROM.

Your technical questions are welcomed. Please address them to CoCo Consultations, THE RAINBOW, P.O. Box 385, Prospect, KY 40059.

We reserve the right to publish only questions of general interest and to edit for brevity and clarity. Due to the large volume of mail we receive, we are unable to answer letters individually.

Questions can also be sent to Marty through the Delphi CoCo SIG. From the CoCo SIG> prompt, pick Rainbow Magazine Services, then, at the RAINBOW> prompt, type ASK (for Ask the Experts) to arrive at the EXPERTS> prompt, where you can select the "CoCo Consultations" online form which has complete instructions.

Last month we took a brief excursion into terminal software choices. We also hit lightly on how the CoCo SIG database areas are organized. Finally, we took a look at the various filename extensions used in the databases. So, we're all set to download! Or are we?

Files

Before we actually go into the SIG and begin downloading, we should take a moment to learn a little about files. Just what is a file? A file is a collection of related characters, or bytes, that are combined to form some meaning. A particular file might be a program. It could also be an article (text file) or even data for a program. Each byte in a file can take on a value from 0 to 255, inclusive. This is because the eight bits that form a byte can be used to form 256 different combinations.

In days past, only seven of the eight bits in each byte were used to form a character. Seven bits can form 128 different combinations. You may be familiar with the term ASCII, which stands for American Standard Code for Information Interchange; this is a code that uses only seven bits from each byte. For our purposes, the eighth bit is meaningless. This means that in an ASCII file, each byte takes on a value from 0 to 127 inclusive. Each byte can be used to represent one of 128 different characters. The ASCII code allows the use of all upper- and lowercase alphabetic characters, the numbers 0 through 9, punctuation and some common "control characters" such as carriage return and line feed.

A text file generated with a word processor is a current example of an ASCII file. Most word processing programs store files in ASCII format or at least have the ability to do so. BASIC programs can be saved in ASCII format on the CoCo, as well. We simply follow the filename with ,A when saving. If this isn't done, the file will be saved in what is called binary format.

A binary file is one in which all eight

Cray Augsburg is RAINBOW's technical editor and has an associate's degree in electrical engineering. He lives in Louisville, Kentucky. His username on Delphi is CRAY.

What's in a file?

Files and Protocols

By Cray Augsburg
Rainbow Technical Editor

bits are used in each byte. This allows the file to contain control codes and graphics information. It also allows the storage of machine language information, since values used in machine language range from 0 to 255.

Some use the terms "compressed" or "tokenized" when referring to BASIC programs saved in binary format. This is because, unless you use the ASCII option (,A), the BASIC keywords (e.g.

PRINT, INPUT, GOSUB, etc.) are not stored as a collection of characters forming that keyword. Instead, BASIC converts each group of characters forming a keyword into a binary value called a token. Each token is a one-byte value. So, the keyword PRINT takes up only one byte instead of five when it is stored. The resultant savings is most obvious on larger BASIC programs stored on disk. Try saving a long BASIC program to disk in ASCII format. Then save it in tokenized format. Compare the amount of disk space used to store each save.

Now that we have an idea about the differences between ASCII and binary, how is that information useful to us? This little bit of information often dictates what methods we use to download a file. One of the main reasons for standardizing filename extensions in the databases was to allow users to have information regarding the filetype before initiating a download. It is also very important when it is time to save that downloaded file.

Protocols

Several methods are available to us for downloading files from online information services. The two basic categories are non-error-checking and error-

Database Report

By Don Hutchison
Rainbow CoCo SIG Database Manager

First off, let me remind you that RAINBOW ON TAPE and RAINBOW ON DISK programs are available online on the Rainbow CoCo SIG and OS-9 Online. These are the same programs and files that are published monthly in the pages of THE RAINBOW.

We publish the programs online each month at about the same time that you receive your copy of THE RAINBOW, so you won't have to wait to download the ones you want. The ordinary BASIC programs are available in the database of the CoCo SIG, while the OS-9 files are available in the database of OS-9 Online. Just type DATA RAINBOW in either SIG to get to these files. Now let's look at the new uploads for this month!

OS-9 Online

In the General topic of the database,

Christopher Burke (COCOXT) uploaded **Burke & Burke Application Note #3**. **Denny Skala** (DENNYSKALA) posted a review of *Stylograph*. **Jim Johnson** (REINDEER) provided a very popular file containing a detailed description of how to build an OS-9 Level II system disk that boots up into an 80-column device window and also creates a VDG screen for use with Level I programs. (Jim also provided a hint in the file on how to run *Koronis Rift* on a VDG screen other than <TERM>.)

In the Programmers Den topic of the database, **Bruce Terry** (THEMAGE) uploaded his *Hordes and Holes* game. In the Applications topic of the database, **Dick White** (DICKWHITE) uploaded the Federal Income Tax form 1040 as a *DynaCalc* spreadsheet for the tax year 1987. (This spreadsheet should also be usable under the RS-DOS version of *DynaCalc*.) **Alan**

checking. Common examples would be the buffer capture method and Xmodem, respectively. Since these are the most common methods used with the Color Computer, they will be the only methods discussed here.

Without going into great detail, suffice it to say you should use the buffer capture method only when dealing with an ASCII file, be it a BASIC program or a text file. During buffer capture each byte is sent as a totally separate entity. The received byte is stored in your computer's memory without regard to its value. And, because of problems with noise on the phone lines, there is no guarantee that the byte sent from the host is the same as that received by your computer. A file downloaded with this method may contain several incorrect characters. Editing an ASCII text file downloaded via this method is painful enough; trying to edit a machine language file under these conditions is impossible. For this reason, if you want to download a file that has been stored in binary format, use an error-checking protocol such as Xmodem.

In an Xmodem download, the information in the file is grouped into blocks of 128 bytes each. Actually, the size of the block is larger than that, but the file content in the block is 128 bytes. The other bytes in the block are used to check that block for errors. If no error is encountered in a given Xmodem block, the sending computer is notified;

it will move on and send the next block. However, if an error is found, the receiving computer will ask the sending computer to send the same block again. This is known as a "retry." Generally, the two computers will allow up to 10 retries. After that, the download is aborted. This process continues until either the file is transferred or the process is aborted. The advantage of using Xmodem is that it can be used to download any type of file reliably. This is why you are urged to purchase a terminal program that supports this, if not some other type of error-checking file transfer protocol.

Moving On . . .

As I indicated last month, the CoCo SIG database is divided into 16 different topic areas, 14 of which are user-accessible. These topic areas are as follows:

- General Information
- CoCo 3 Graphics
- Source for 6809 Assemblers
- Utilities & Applications
- Hardware Hacking
- Games
- Classic Graphics
- Music & Sound
- Info on Rainbow
- Archives
- HELP
- Product Reviews & Announcements
- Rainbow On Tape
- Data Communications

Sheltra (PHDRAGON) provided CCDEX.B09, a Rolodex-type program for names and addresses. **Pat Abramovitch** (HUBBS) posted the source code for his CHECK09 program.

In the Utilities topic of the database, **Pete Lyall** (OS9UGVP) provided MORE.AR, a MORE-like program similar to that provided under UNIX. Bruce Terry uploaded LISTER.AR, a text file listing utility with pagination and header options.

In the Device Drivers topic of the database, **Karl McMurdo** (XRX23) posted PPRINT.AR, which contains a driver and device descriptor for the parallel port described in the November and December '87 issues of THE RAINBOW. **Alan Parker** (ALPARKER) uploaded a printer driver to be used with the Star SG10 printer and Tandy's Home Publisher.

In the Patches topic of the database, **Dave Philipson** (DPHILIPSEN) posted COPY-PATCH.AR, an IPatch file, and documentation to patch the OS-9 Level II Copy command to overwrite existing files. If an existing file has been selected as the destination file, the patched Copy command will ask if it should be overwritten.

Jason Forbes (COCO3KID) uploaded GAME-PATCHES.AR, an IPatch file that contains a series of patches that will fix *Koronis Rift* and *Rescue on Fractalus*. **Dave Archer** (DAVEARCHER) provided FIXRX, a patch that allows the Epson printer driver (prn.EpsonRX) to be used with a Gemini 10X printer. **Ken Scales** (KSCALES) uploaded KEYTAB03, a set of patches to CC310 to provide alternate mapping for the non-alpha key codes, allowing the arrow and function keys to be used more easily under *DynaStar*. The two key maps may be toggled independently on a per-window basis.

In the Telecommunications topic of the database, **Bill Brady** (OS9UGED) uploaded XMac, an Xmodem fileserver. XMac is the missing ingredient that you need to make OS-9 a BBS in its own right. XMac allows a user logged on to your system to transfer files in the Xmodem protocol. Bill also provided WIXMOD.I, a replacement Xmodem module for *The Wiz*. This new version is much faster than the original, and fixes two problems. **Merle Kemmerly III** (TOOK3) provided C functions that allow you to transmit files via Xmodem pro-

For our purposes, it may be easier to view the database as 14 different databases. Another visualization aid is the file cabinet. Imagine the database as a 14-drawer file cabinet and each drawer as being one of the 14 database topic areas. When you type DAT at the CoCo SIG prompt, you are asked for a topic. Delphi is just asking which drawer you want to look through. Pick one and Delphi will put you there — it will open that drawer for you. In picking a topic area, you need enter just the first three characters of that area to make your entry unique. Just as with other prompts on Delphi, abbreviations work fine here.

When the drawer is first opened, you will find yourself at the "top" of the chosen database. For instance, if you choose the Music & Sound topic at the TOPIC>? prompt, you will see the DBASES:Mus> prompt appear on the screen. You are now ready to look through the file drawer and see what's there. For instructions on this, I refer you to last month's Delphi Bureau.

Because of its design, the file cabinet is somewhat precariously balanced. You can have only one drawer open at any one point in time. Otherwise, the file cabinet would fall over. In other words, you can't be in two different topic areas at the same time. Not to worry, though. Delphi will take care of this for you. And you can switch drawers quite easily. This is done with the SET command. The SET command can be en-

tol. **Warren Hrach** (WAROCK) posted DYNALOG, a BASIC09 procedure for converting *Wiz* autolog files to *DynaCalc* files.

In the Graphics & Music topic of the database, **Rick Adams** (RICKADAMS) uploaded three of his favorite shell scripts for setting up one, two or three windows in OS-9 Level II. They create the windows, initiate the fonts, set up the proper color sets, head up each window with a neat-looking label, and then start the shells. **Michael Washburn** (COMPZAP) posted a modpatch file for using *Home Publisher* with Gemini 10x printers. **Jimmy Lemke** (JIMLEM50) uploaded a *Star Trek* game. **Brian Stretch** (BRIANSTRETCH) posted SHELICON.AR, a nice, simple 80-by-24 icon to replace the "cute" window created by Gshell under *Multi-View*. Dave Archer uploaded MAC, an ARCDed file containing a scrolling Macintosh picture viewer, a Gemini 10X printer dump for the picture, and associated documentation.

CoCo SIG

In the General topic of the database, **Mike Andrews** (MANDREWS) provided a very interesting and detailed listing of

tered at either the DBASES> prompt (top of the database) or the ACTION> prompt (discussed last month). Just enter SET, followed by the first three characters of the new topic area. For instance, we are now in the Music & Sound database. To change drawers and go to the CoCo 3 Graphics database, enter SET CDC and you're there!

To complete the file cabinet scenario, let's take a look at groups. The CoCo SIG is the filing cabinet, and the drawers are the individual databases or topic areas. Each folder in a given drawer represents a group. On Delphi, a group is a collection of one or more files. Note that a group might have just one file in it. When you type DIR (or just press ENTER) at the DBASES> prompt, the directory you see is actually a list of the group names, or folders, within that database, or drawer.

Before you can download from a

group, you must open that group by reading it. This is done by typing READ, followed by the name of the group as it appeared in the directory. Again, abbreviations work here. The only rule

"A binary file is one in which all eight bits are used in each byte. This allows the file to contain control codes and graphics information."

"smilies," the text/art "faces" that are so popular in Mail and Conference. I (DON-HUTCHISON) provided a humorous file called "Tenne-C," which is a mock product announcement for a new C compiler.

In the CoCo 3 Graphics topic area, **Donald Ricketts** (STEVEPDX) was this month's most active uploader, providing us with over 130 digitized images and conversions! Most of these are digitized images that have been converted to *CoCo Max III* format. Thanks, Donald! **Richard Trasborg** (TRAS) sent us LCG.MGE, a graphics advertisement (drawn by Mike Trammell) for a Staten Island BBS that specializes in graphics. In response to a SIG member's request, Richard also uploaded a *CoCo Max III* picture of Loni Anderson converted from a Macintosh picture, and several other *CoCo Max III* pictures that he converted from DS-69 digitized images. **Ken Schunk** (KENSCHUNK) uploaded a *QuickBASIC* program for IBM compatibles that lets them display digitized DS-69 pictures from the CoCo SIG. **Orman Beckles** (ORMAN) uploaded his *FireStorm* program for simultaneously generating interesting graphic displays and relaxing music. **Roger Bouchard** (HARBIE) uploaded a very popular utility for converting 256-by-256 digitized images into HSCREEN2 pictures. Roger also uploaded an MGE demo program he wrote for his local Radio Shack store. The program will continuously display all of the MGE pictures on a disk to demonstrate the graphics abilities of the CoCo 3.

In the Source topic of the database, **Mike Ward** (MIKEWARD) provided the source code for his MUSORC program, which he posted in the Music topic of the database. The full program allows one to play *Musica* files in stereo through the *Orchestra-90* pack.

In the Utilities & Applications topic of the database, Brian Stretch provided parallel port printer drivers for use with the JFD-CP disk controller. Brian provided a version for CoCos 1 and 2 and a separate version for the CoCo 3. **Bob Montowski** (GRAPHICSPUB) uploaded an Ipatch file to allow the use of a Gemini printer with *Home Publisher*. **Rodger Alexander** (SALZARD) uploaded an ARCDed file called STAREdit, which contains a utility for editing downloadable character sets for the line of Star printers. Orman Beckles provided his *Palette Master* program, while **Hadley Hazen** (HAZE) uploaded Version 2 of his disk label-maker program.

In the Hardware Hacking topic of the database, **Marty Goodman** (MARTYGOODMAN) uploaded a valuable text file chock-full of analog RGB video information.

In the Games topic of the database, **John Barrett** (JBARRETT) uploaded four games: *Moon Miner*, *Seeker*, *StarWays* and *Interstellar Kamikaze*. **Nathan Camp** (NATHANCAMP) uploaded his help program for dungeon masters, and **David Yale** (DAVEYALE) uploaded the "DM Friend" program that he wrote three years ago. **Blair Hogg** (BLAIRH) provided information on moving *Flight Simulator* to other types of disks. **Paul Dion** (PAULNORMAND) provided two games written in BASIC called *Gorfland* and *Dfishing*.

In the Classic Graphics topic of the database, **David Mills** (DAVIDMILLS) uploaded a great demonstration program of his space shuttle and database package. Orman Beckles uploaded some famous faces from science fiction pictures, and several pictures of Barry Silverman in various formats.

In the Music & Sound topic of the database, **Mike Ward** (MIKEWARD) uploaded his popular MUSORC utility program

is that you must enter enough characters to make your entry unique so Delphi knows exactly which group you want to look at.

When you have opened the group by reading it, you will then see a brief description of the group along with the name(s) of any file(s) it contains. To continue with the filing cabinet metaphor, liken each file to a piece of paper within the chosen folder.

Short of actual downloading procedures, you are armed with enough information to really get going. I urge you to log on and take a look around the databases. See what's there. If you are adventurous, try downloading. Experience is the best teacher. If you really get things fouled up, just turn your modem off, get back online and try again. For those who are more faint of heart, we'll take a look at actual downloading next month. □

in response to several questions in the CoCo SIG Forum. This utility will allow you to play your *Musica* files through the *Orchestra-90* pack in stereo. It uses the all-RAM, high-speed mode to improve the music quality. You may interrupt any tune in mid-play by pressing BREAK. It also provides for playing all of the tunes on the current disk. Orman Beckles uploaded several music files, including lost music from *Star Trek*, *Color Midi II* music, the "Post Frowien Blues," and several *Colorchestra* files. Orman also posted *The Creator*, a utility to change your *Musica II* files into stand-alone binary files.

In the Archives topic of the database, Dick White posted eight more archived polls.

In the Product Reviews & Announcements topic of the database, Christopher Burke provided a product announcement about Version 2.0 of *Hyper I/O*. Steve Ricketts provided a text file of his experiences with *Word Power 3*, and **Jim Goettig** (JGGMG) uploaded a revision to his original review of *Word Power 3*. **Jim Reed** (JIMREED) posted a text file that gives a quick peek at the features of the new *Telewriter-128* from Cognitec.

In the Data Communications topic of the database, Mike Ward provided a modification for Version 4.7 of his popular terminal program *MikeyTerm* that forces it to wait for an acknowledgment from the host after an Xmodem upload has completed. If you are having trouble with aborted uploads after they appear to have completed OK, or you want to rid yourself of that "Second EOT missing" message on Delphi after an Xmodem upload, you might want to try this modification.

As you can see, we had a very active and interesting month on the Rainbow SIGs! Hope to see all of you online on Delphi!

XTEAM & OS-9

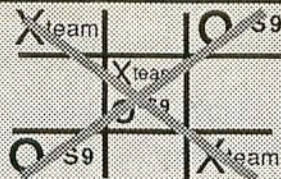

BOTH WINNERS

All of our OS-9 products work with:

- OS-9 version 1
- OS-9 version 2
- OS-9 Level 2

XTERM

OS-9 Communications program

- Menu oriented
- Upload/download Ascii or XMODEM protocol
- Execute OS-9 commands from within XTERM
- Definable macro keys
- Works with standard serial port, RS232 Pak, or PBJ 2SP Pack, Includes all drivers
- Works with standard screen, Xscreen WORDPAK or DISTO 80 column board

\$49.95 with source **\$89.95**

XDIR & XCAL

- Hierarchical directory
- Full sorting
- Complete pattern matching
- OS-9 calculator
- Decimal, Hex, Binary
- +, -, *, /, AND, OR, XOR, NOT

\$24.95 with source **\$49.95**

XDIS

OS-9 disassembler

\$34.95 with source **\$54.95**

HARDWARE

- 512k memory upgrade **\$80.00**
- Ram Software
- Ram Disk
- Print Spooler
- Quick Backup
- All three for only **\$19.95**

*Software by ColorVenture

XWORD

OS-9 word processing system

- Works with standard text screen, XSCREEN, WORDPAK, or DISTO
- True character oriented full screen editing
- Full block commands
- Find and Replace commands
- Execute OS-9 commands from within
- Proportional spacing supported
- Full printer control, character size, emphasized, italics, overstrike, underline, super/sub-scripts
- 10 header/footers
- Page numbering in decimal or Roman numerals
- Margins and headers can be set different for even and odd pages

\$69.95 with source **\$124.95**

XMERGE

Mail merge capabilities for XWORD

\$24.95 with source **\$49.95**

XSPELL

OS-9 spelling checker, with 20000 and 40000 word dictionaries

\$39.95

XTRIO

XWORD/XMERGE/XSPELL

\$114.95 with source **\$199.95**

XED

OS-9 full screen editor

\$39.95 with source **\$79.95**

AND FOR RS DOS ...

SMALL BUSINESS ACCOUNTING

This sales-based accounting package is designed for the non-accountant oriented businessman. It also contains the flexibility for the accounting oriented user to set up a double entry journal with an almost unlimited chart of accounts. Includes Sales Entry, transaction driven Accounts Receivable and Accounts Payable, Journal Entry, Payroll Disbursement, and Record Maintenance programs. System outputs include Balance Sheet, Income Statement, Customer and Vendor status Reports, Accounts Receivable and Payable Aging Reports, Check Register, Sales Reports, Account Status Lists, and a Journal Posting List.

\$79.95

INVENTORY CONTROL/SALES ANALYSIS

This module is designed to handle inventory control, with user defined product codes, and produce a detailed analysis of the business' sales and the sales force. One may enter/update inventory data, enter sales, run five sales analysis reports, run five inventory reports, set up product codes, enter/update salesman records, and update the SBAP inventory.

\$59.95

Call for package price

PAYROLL

Designed for maintaining personnel and payroll data for up to 200 hourly and salaried employees with 8 deductions each. Calculates payroll and tax amounts, prints checks and maintains year-to-date totals which can be automatically transferred to the SBA package. Computes each pay period's totals for straight time, overtime and bonus pay and determines taxes to be withheld. Additional outputs include mailing list, listing of employees, year-to-date federal and/or state tax listing, and a listing of current misc. deductions. Suited for use in all states except Oklahoma and Delaware

\$59.95

PERSONAL BOOKKEEPING 2000
Handles 45 accounts. Enters cash expenses as easily as checks. Handles 26 expense categories. Menu driven and user friendly.

\$39.95

ACCOUNTS RECEIVABLE

Includes detailed audit trails and history reports for each customer, prepares invoices and monthly statements, mailing labels, aging lists, and an alphabetized customer listing. The user can define net terms for commercial accounts or finance charges for revolving accounts. This package functions as a standalone A/R system or integrates with the Small Business Accounting package.

\$59.95

ACCOUNTS PAYABLE

Designed for the maintenance of vendor and A/P invoice files. The system prints checks, voids checks, cancels checks, deletes cancelled checks, and deletes paid A/P invoices. The user can run a Vendor List, Vendor Status report, Vendor Aged report, and an A/P Check Register. This package can be used either as a standalone A/P system or can be integrated with the Small Business Accounting Package.

\$59.95

MICROTECH CONSULTANTS INC.

1906 Jerrold Avenue
St. Paul, MN 55112

Dealer Inquiries Invited
Author Submissions accepted
OS-9 is a trademark of Microware



Ordering Information

Add \$3.00 shipping & handling, MN residents add 6% sales tax.
Visa, Mastercard, COD (add \$3.50), personal checks.

(612) 633-6161

An easy way to produce good-looking documents

Formatting Text With *Telewriter*

By Jose L. Jimenez

Our family was divided between *Color Scrispit* and *Telewriter-64*. My son used to think *Scrispit* was the greatest until he saw the quality of work possible with *Telewriter-64*. I changed his loyalty by providing him with a very simple means of accessing some of the more complex features of *Telewriter-64*, such as using different type fonts on the same page and making lines, charts and even extra-large characters and graphics.

In this article I will show you how you can easily use *Telewriter-64* to format your text.

Different Type Fonts

Most modern printers have a variety of fonts that can be accessed by sending the appropriate control codes to the printer. With *Telewriter-64* you can make dynamic changes of fonts within the text — not all word processors can do this. The following examples access the fonts most common on the Tandy series of printers, except for the DMP-100:

```
CONDENSED
NORMAL
CONDENSED+ELONGATED
NORMAL+ELONGATED
```

Using *TW64*, type the following

Jose L. Jimenez owns his own business and lives in San Jose, Costa Rica. He and his family enjoy programming on the CoCo and put it to use in the business.

listing and save it as PRINTDRI/TWR:0 on the same disk as your *TW64* backup:

```
^T 05 15 20 25 30 35 40 45
50 60 [TABS]
^D1 014
^D2 015
^D3 18
^D4 27 14
^D5 27 15
^D6 27 19
^D7 27 20
^D8 30
^D9 94
^T =====
^S1 M0 C72 U2 L66 B5
^T =====
```

(This provides printer control code definitions.) You can also add the printer control codes shown in Figure 1. If you need more memory, the chart can be deleted by using CLEAR-E at the end of the chart and CLEAR-X at the beginning of the chart.

Notice (in Figure 2 and the listing) we have used an up arrow (^) character before the instruction. To generate the up arrow, use CLEAR-. The ^ is an *instruction* sent to the printer. After the ^ we must define whether the instruction is functional, change of character size, condensed, normal, etc., or if it is a special character that is not found on the keyboard. If we follow the ^ with

Figure 1: Printer Control Codes

Function	Control Code
Bold start	27 31
Bold end (new)	27 32
Bold end (old)	27 30
Elongated/pitch start (new)	27 14
Elongated end (new)	27 15
Elongated (old)	31
Elongated (new)	32
Type, proportional, select	27 17
Type, 10 pitch, correspondence, select	27 18
Type, 10 pitch, standard, select	27 19
Type, 12 pitch, correspondence, select	27 29
Type, 12 pitch, standard, select	27 23
Type, condensed, select (new)	27 20
Type, condensed, select (old)	27 14
Type, condensed, cancel (old)	27 15
Type, italics	27 66
Type, microfont	27 77

DP, it is a *printable instruction*. If we follow the ^ with D, this is a *control instruction to the printer* such as condensed, normal, etc.

Accessing Printer Character Fonts

In order to access any font your printer has, place the file PRINTDRI/TWR at the beginning of your new file. All you need to do is press CLEAR-#. The # is any number from 1 through 9. Zero is reserved for a 51-column display mode and cannot be used for printer control codes. For instance, if you want a word to be condensed, press CLEAR-7 (press CLEAR and 7 simultaneously). Notice that a small number 7 appears on the screen. Do not forget to place CLEAR-6 at the end of the word, phrase or paragraph to come back to normal characters. Access to other fonts is described in Figure 2.

If your printer has more font sets than are covered here (such as bold, italics, microfont, etc.), you can redefine any of the nine controls on the table of Control Code Definitions at the beginning of PRINTDRI/TWR and establish your own. By using the proper CLEAR-# you will obtain the results you need for other print controls. See Figure 1.

If you run out of control codes 0 through 9 (it happens to me quite often), you can redefine controls at any time within the text. The printer goes by the last definition you made.

It is a good habit to end all files on normal operation of your printer to avoid having to turn it off to reset normal operation — quite an inconvenience for the next user.

Additional Printer Control Codes

The printer controls in Figure 1 were taken from *How to Use Your Radio Shack Printer*, Page 56, by William Barden, Jr., published by Tandy. Check your printer manual to establish which one you can use.

Setting Up a Permanent Printer Format

By typing in and saving PRINTDRI/TWR on the same disk with your *Telewriter-64* backup, you are able to make a simple format of your next file. Simply read in PRINTDRI/TWR:0 and proceed to type your new file. For existing files, you can read in PRINTDRI/TWR and append your existing file.

Characters Per Line

Each font requires different spaces to be printed, and it is difficult to guess or count the number of characters that fit in one line. The graphic rulers in Figure

Figure 2: Reference Chart of Printer Format Codes

Format Instruction	Printer Control Code
^S Single line	^1 Ends underline
^M Left margin	^2 Begins underline
^C Characters per line	^3 Select graphics mode
^U Upper margin	^4 Begins elongated
^L Lines per page	^5 Ends elongated
^B Bottom margin	^6 Select normal characters
^T 1st line tabulator Doesn't print line	^7 Condensed characters
	^8 Ends graphics mode
	^9 Up arrow

SPECIAL CHARACTERS:

^ CLEAR period	[SHIFT up arrow
\ CLEAR comma]	SHIFT CLEAR

Printer Control	CLEAR+number or letter
^47 Long condensed 56	^N Skip page
^46 Normal long --56	^Q FILE/EXT:0 next file
^7 Condensed ----6	^:] Do not justify

Figure 3

S = Line spacing	1 = Single Space 2= Double Space	[1]
M = Left margin	0 = Zero spaces on the left side	[2]
C = Characters per line	80 = 80 characters limited by printer	[3]
U = Upper margin	0 = Zero lines empty on top of page	[4]
L = Lines per page	66 = 66 full line feeds per page	[5]
B = Bottom margin	0 = Zero lines empty on the bottom	[6]

[1] values of 0 to 255 maximum.

[2] 0 to 255 maximum. Left margin plus characters per line cannot exceed the capacity of the printer (usually 80- or 132-column) on the size of character you are using. You can print in multiple columns by changing the left margin and making multiple passes. A good combination of format control for two columns with condensed (132-column) characters is ^M5 C57 M5 for the first column and ^M70 C57 for the second. Place the second instruction on the page break and use the One Page control on the Format menu.

[3] 0 to 127 maximum. Right margin is determined by the capacity of the printer minus the

left margin minus the characters per line.

[4] Default is 4.

[5] Normally, a printer defaults to full line feed, but you can also alter this condition either under program control or sending control to the printer. Early Radio Shack printers could only move the paper forward (such as the DMP-120). Newer printers can move backward to print accents and do graphics work. Half-forward and half-backward are used in conjunction with superscript and subscript. See the chart below for different types of line feed.

[6] Default is 4, but must be at least 3 to print page numbers on the bottom.

Type of Line Feed	Line Feeds Per Page	Movement	Control Code
Full Forward Line feeds	66	0.166 inches	27 54
3/4 Forward Line feeds	88	0.125 inches	27 56
1/2 Forward Line feeds	132	0.833 inches	27 28
1/12 Forward Line feeds	550	0.020 inches	27 50
Full Backwards Line	66	0.166 inches	27 10
1/12 Backwards Line	550	0.020 inches	27 30



Orders up to \$50 subtract 15% OFF

Orders over \$50 subtract 20% OFF

offer extended 5/31/88

Name _____
 Address _____
 City _____ State _____ Zip _____
Yes! Send me your FREE catalog!
 VISA MasterCard
 Card # _____ Exp. _____
 Signature _____

Add shipping: \$3 surface in the US
 or \$6 for air/Canada.

This coupon must be presented or
 mentioned with order to receive
 discounts.



COMPUTERWARE

(619) 436-3512

Box 668 • Encinitas, CA • 92024

6% Calif. Sales Tax
 COD Add \$5
 Shipping*
TOTAL

Item	Format	Price

GAMES

- Return of Junior's Revenge**
 Arcade of Donkey King Junior.
 Req CoCo 3 Disk, joystick \$24.95
- Nuke the Love Boat**
 Strategy simulation/adventure.
 Req CoCo 3 Disk, mouse or joystick \$24.95
- Magic of Zanth**
 Dragons, demons, graphics & adventure.
 Req CoCo 3 Disk \$24.95
- Iron Cross**
 World War II simulation.
 Req 64K, Ext Basic, RSDOS \$24.95

PROGRAMMING TOOLS

- CoCo 3 Ramdisk & Diagnostics**
 512K memory diagnostics, double ramdisk, & mastercopy utility.
 CoCo 3 Disk \$19.95
- Color Basic Compiler**
 Compiles Basic code into machine language. List of commands available.
 Req 32K RSDOS \$29.95
- Macro Conditional Assembler**
 Supports 6809 mnemonics & directives, macros, conditional assembly, repeat sequences, source library files...
 32K RSDOS \$34.95
 64K OS-9 \$39.95
- Sourcerer**
 Disassembler & source generator.
 32K RSDOS \$29.95
 64K OS-9 \$29.95

PERSONAL PRODUCTIVITY

- CoCo Cookbook**
 Recipe file stores title, ingredients & instructions in free-format data base.
 Req 32K RSDOS \$29.95
- C.E.O.**
 Electronic desktop organizer — appointment calendar, calculator, clock with alarm, phone directory, & file-drawer for memos.
 Req 64K RSDOS \$34.95
- Personal Finance System**
 Checkbook organizer with personal chart of accounts, budgets, & special investment & loan calculation module.
 Req 32K, RSDOS, printer \$29.95
- Merge 'n Mail**
 Name & address data base with reports, label printing, & merge feature for word processor letters. For CoCo I or II only.
 Req 64K RSDOS \$29.95

- Pac Attack**
 Popular arcade action.
 16K cass \$16.95
 32K RSDOS \$19.95
- Bloc Head**
 Q-bert jumps over cubic surfaces.
 16K cass \$16.95
 32K RSDOS \$19.95
- Mr. Dig**
 Dig-Dug arcade fun.
 32K Cass \$16.95
 32K RSDOS \$19.95
- Treasure of the Aztecs**
 Unique graphic adventure in Mexico City.
 64K cass \$19.95
 64K RSDOS \$24.95
- Escape: 2012**
 Graphics space adventure with over 35 objects & 137 rooms in 3 dimension maze of 4 levels with 2 arcade sequences.
 64K cass \$19.95
 64K RSDOS \$24.95

OS-9 ONLY

- Sam Sleuth**
 Work as a Private Eye to solve 3 cases — different every time! Req joystick or mouse.
 64K cass \$19.95
 64K RSDOS \$24.95
- Pro Golf**
 Challenging simulation includes practice on putting green & driving range. 36 holes with life-like conditions to master.
 Req 32K, RSDOS, Ext Basic \$24.95

BUSINESS APPLICATIONS

(all require 64K & dual drives)

- General Ledger** \$99.00
Check Ledger \$99.00
Inventory Control \$99.00
Accts Payable \$99.00
Accts Receivable \$99.00
Payroll \$125.00

- Texttools**
 Utilities for text file manipulation.
 Req OS-9 \$29.95
- OS-9 Combo Utilities**
 Utilities for every advanced user!
 Req OS-9 \$49.95
- OS-9 Basic**
 Written for programmers by programmers.
 Req OS-9 \$39.95
- Data Master**
 Full featured data base system.
 Req OS-9 Level 2 \$64.95
- Screen Star**
 Screen editor implementation of WordStar edit set.
 Req OS-9 \$49.95
 w/Formater \$74.95
- OS-9 Text Formatter**
 Advanced formater interfaces with any ASCII editor.
 Req OS-9 \$34.95
 w/Screen Star \$74.95

MODEM SOFTWARE

- Color Connection**
 Comprehensive modem software supports Protocol B, XMODEM protocol, & XON/XOFF; all baud rates, expandable buffer, macros. CoCo I, II, & III included.
 Req 32K RSDOS \$49.95
- OS-9 Connection**
 Comprehensive modem software supports Protocol B, XMODEM protocol, & XON/XOFF; all baud rates, expandable buffer, macros. Level I & II included.
 Req RS232 pak, OS-9 \$49.95

- Colorbowl Football**
 Each team has 6 players & you control the quarterback or roving safety using joysticks. Practice alone or play against your opponent.
 32K cass \$19.95
 32K RSDOS \$24.95
- Bio Detector**
 Bio feedback & Lie detector game. All hardware & software included.
 Req 16K \$24.95

Back in February '85, I wrote an article describing how the Tandy Multi-Pak worked. I followed that up with a project involving a little circuit that could decode the latched bits and drive some LED digits to tell you which slot was active. Since there were two active areas of memory available in the Multi-Pak, you needed two LED digits and two driver chips. It worked well for a time but, as always, Tandy likes to throw some curves — they changed the insides of the Multi-Pak.

In order to make the Multi-Pak less expensive to make, and therefore less expensive to buy, they took many of the chips, grouped them together and made one big custom clip. This was great for them, as the price for the Multi-Pak went down and they sold more of them. Good for them, but not so good for my circuit — it no longer worked. Those latched bits I used to get the data to drive the LEDs are no longer there.

When this new Multi-Pak came out in '86, I got a few letters asking if there was anything I could do. At the time I thought it would be too much trouble to redesign the circuit, too many chips and too much work for it to be worthwhile to build. But lately I've had some calls about this one again. So here goes another big project.

Reviewing the Multi-Pak

Let's recap what was said in that article. The first half of the article described the functions of the Multi-Pak and the second half described how to hook up LEDs to tell you which slot is active. The two active areas in the Multi-Pak are the CTS and the SCS areas. The CTS is mapped from \$C000 to \$FEFF for CoCos 1 and 2 and from \$C000 to \$FDFF for the CoCo 3. The SCS is mapped from \$FF40 to \$FF5F on all three CoCos. These mapped areas can be switched to any of the four slots of the Multi-Pak, together or independently. That means you can have the CTS in Slot 4 and the SCS in Slot 2 if you want.

These memory areas can be switched both in hardware (via the switch on the front of the Multi-Pak) or in software

Tony DiStefano is a well-known early specialist in computer hardware projects. He lives in Laval Ouest, Quebec.

*Using LEDs to
see which slot on your
Multi-Pak is active*

Multi-Pak LED Update

**By Tony DiStefano
Rainbow Contributing Editor**

(via one memory location). The switch is simple to operate; before turning the computer and Multi-Pak on, slide the switch to the desired slot number. When you turn the computer on, the active area (or slot) is identical to the slot number on the switch in front. The hardware switch cannot change the SCS and CTS separately, only both of them at the same time. Sliding the switch to another slot number with the power on will change slot access, and probably crash your software program at the same time. There is, however, a time when the switch no longer works to switch these areas.

Let's go back to the software switch. It, too, can change the active slot area; it does so by writing a number to a read/write byte in the memory map, the byte at \$FF7F. This byte is divided into two nibbles (a nibble is four bits); the lower nibble controls the SCS area and the upper nibble controls the CTS. A value of 0 to 3 in any of these nibbles selects slots 1 to 4, respectively. One interesting thing this memory byte does, once you've written to it, is lock out the hardware switch. Sliding the switch on the front panel does not work after you have changed the slot access from software.

Now, both the newer and older Multi-Paks do the same thing. But because we don't have access to the latched bits on the newer board, the project I did back in 1985 will not work

on the new Multi-Pak. The circuit I have come up with now works just like the older Multi-Pak's circuit, allowing you to hook up the LEDs as before.

The Project

This circuit requires just five chips. These chips can be mounted on a small PCB that you can get from any Radio Shack. It does not require an edge connector, because it does not connect to the slots of the Multi-Pak. Instead, you have to open up the thing and insert this circuit inside. This is not too bad, because you have to open it up anyway to get the LEDs in there.

Figure 1 shows the circuit in question. A step-by-step description will help you understand it. Let's start with U1 and U2: These chips are used to decode the memory map into one byte, Byte \$FF7F, which is 16 bits long. Out of these 16 bits, 15 of them are 1s and only one of them is 0. The 74LS133 (U1) takes care of 13 of them. When all of these are high, the output goes low. This output goes to U1, a 74LS138, where the E clock, read/write line and the rest of the address lines are decoded. Only one output is used to write to the 74LS173, which is a four-bit latch used to record what slot is active.

The 74LS368 is a six-bit buffer (we will use only four bits, however) whose input comes from the switches on the front of the Multi-Pak. You can get these signals from the 64-pin chip inside the Multi-Pak. The A pin in Figure 1 connects to Pin 21 of IC 6, and B connects to Pin 22 of the same chip. These two signals are split to form the four bits necessary for the LEDs. This is where the four connections of the LEDs project connect to. Here is the connection list for these pins:

Pin No.	U13 of LEDs Project
C	2
D	3
E	14
F	13

This chip (U5) will output the status of the front switch when the Multi-Pak is first turned on, due to the U4, a 74LS74. This is a D-type flip-flop. On power-up or reset, the Q (Pin 5) output of this chip is low, which activates U5. At the same time, *Q (Pin 6) is high,

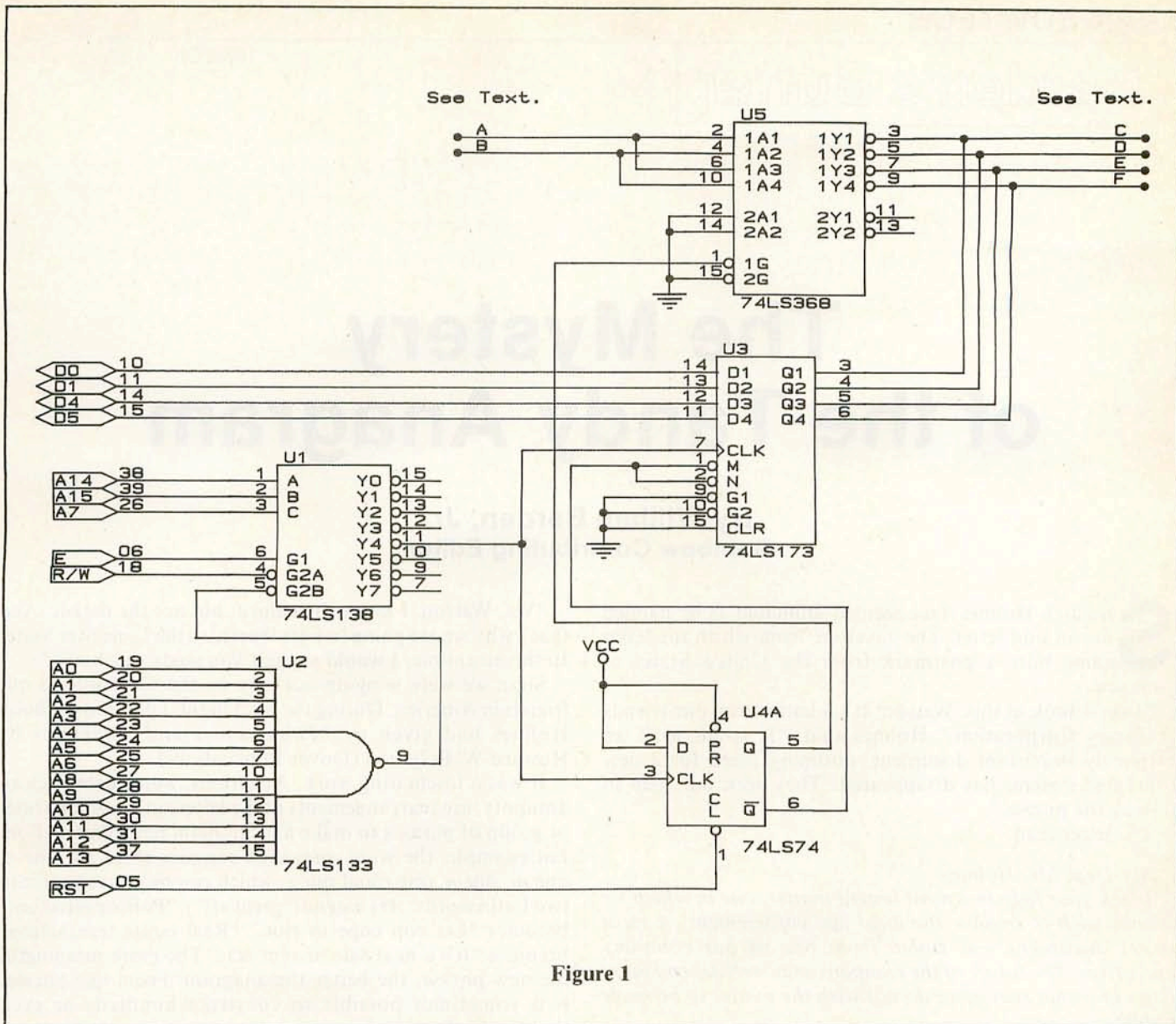

Figure 1

which keeps U3 in activated (tri-state). U3 has to be kept in this state because no data has been assigned to it; that would give random values to the LEDs. On the other hand, U5 is activated to give the status of the switch, which conforms to the old Multi-Pak.

The output of U1 also goes to the clock input of U4, so when your software program writes to \$FF7F, to change the active slot for the first time, it flips the outputs Q and *Q. This, in turn, deactivates U5 (connected to the switches) and activates U3. The new values just entered into the latch at U3 are now valid, and the flip-flop action of U4 brings this data out to the LEDs. From then on, changing the switch has no effect on the LEDs. The switch will have no effect until one of two things happens: Either a reset occurs or the power is turned off. Pressing the reset button will again flip U4 back to its

original state and therefore re-enable the switches. Turning the power off also flips the condition of U4.

This project for the newer Multi-Pak is not very difficult, but you must have done (or do now first) the project from 1985 for this one to be useful. The standard project builder's kit is necessary. These parts are not available from Radio Shack, but are at most well-stocked electronics shops. Active Electronics is my best source for almost all the electronics parts I buy.

There is one more thing yet to do; The program I use to generate the circuit diagram in Figure 1 does not put in the pin numbers for 5 volts and ground. Figure 2 shows a list that explains which pin goes where in the power and ground department.

In the Multi-Pak, you can get 5 volts from Pin 9 of the connector and ground connections from pins 33 and 34.

Chip #	+5 Volts	Ground
U1	16	8
U2	16	8
U3	16	8
U4	14	7
U5	16	8

Figure 2

In my January 1988 column (Page 144), I requested that my readers send in a hardware projects "wish list." I have gotten a few responses.

Some have been good, and I will get to work on them, but some are a bit far-fetched. Try to keep your ideas limited to small projects — some guys asked to do a project that would cost several times the price of the computer, the Multi-Pak, my drives and then some!



Barden's Buffer

The Mystery of the Tandy Anagram

By William Barden, Jr.
Rainbow Contributing Editor

Sherlock Holmes' face seemed animated as he handed me an odd letter. The envelope from which the letter came bore a postmark from the United States of America.

"Take a look at this, Watson. It's a letter from our friends at Tandy Corporation," Holmes said. "It seems as if an extremely important document, outlining plans for a new computer system, has disappeared. They seek our help in solving the puzzle."

The letter read:

My Dear Mr. Holmes:

I seek your help in a most urgent matter, one in which we do not wish to involve the local law enforcement. A most secret document was stolen from one of our company executives. The future of the company may well depend upon it, and for that reason we do not wish the matter to be made public.

My name was signed on a note the thief left, and I am under suspicion.

Name your price, Mr. Holmes. We will be most pleased if you will help us in this matter.

*Your humble servant,
Gil B. Ube
Vice President
Assembly and Dissembling*

"My dear Watson, can Mrs. Watson spare you for a few days?"

"Of course, Holmes. As a matter of fact, she's at her sister's in Chesterfield."

"Then there's no time to lose, Watson. I fear the culprit may already be out of our reach!"

"But, Holmes, do you mean you have already solved the mystery?" I exclaimed.

Bill Barden has written 27 books and over 100 magazine articles on various computer topics. His 20 years' experience in the industry covers a wide background: programming, systems analysis and managing projects for computers ranging from mainframes to micros.

"Yes, Watson, I know the culprit, but not the details. And that's why we are going to Fort Worth, to the Lone Star State! In the meantime, I would suggest you study this book."

Soon we were winging our way on the Concorde to our friends in America. During the brief flight, I perused the book Holmes had given me, *Palindromes and Anagrams* by Howard W. Bergeson (Dover Publications).

It was a fascinating work. Anagrams, which date back to antiquity, are rearrangements of the letters in a word, phrase, or group of phrases to make a meaningful new construction. For example, the word *anagrams* contains three *a*'s, one *g*, one *m*, one *n*, one *r* and one *s*, which can be rearranged into two Latin words: *Ars magna* ("great art"). "Police protection" becomes "Let cop cope in riot." "Real estate transaction" becomes "It's a neat sale or rent act." The more meaningful the new phrase, the better the anagram. From one phrase, it is sometimes possible to construct hundreds or even thousands of anagrams.

Charades are another form of anagrams. In charades, the letters are left in the same order, however. "Amiable together" becomes "Am I able to get her?"

Palindromes, the book went on to say, are not only anagrams, in which the same letters and number of letters are used in the new phrase, but the phrase reads the same forward and backward! The most famous palindrome is, perhaps, "A man, a plan, a canal — Panama!" Another famous palindrome is Napoleon's lament, "Able was I ere I saw Elba."

A palindromic sentence is a structure in which the *words* read the same forward and backward, for example: "You can cage a swallow, can't you, but you can't swallow a cage, can you?" Long poems or narratives have been written using palindromes by letters or by words. The more meaningful the poem, the better the palindrome.

I set the book aside and turned to Holmes. "I say, Holmes, this is a capital book, but what does it have to do with the problem in Fort Worth?"

"All in good time, Watson, all in good time," said he.

The Concorde landed at the Dallas/Fort Worth air terminal, and we were whisked away by the Tandy Hyundai limousine. During the short drive from the terminal to One

Tandy Center, Holmes was reflective, finger tips steeped together and elbows on knees.

We were met at One Tandy Center by Gil B. Ube, a Tandy vice president from Japan. He was a fit-looking businessman, dressed in traditional Tandy gray.

He offered us his hand in greeting.

"Ah, Mr. Holmes. I'm so happy you found the time to help us with our problem. And, I might mention, *my* problem, since the thief has used *my* name."

"Mr. Ube, it is my pleasure to be able to help. I am a longtime admirer of Tandy products, and have a Color Computer 3, a Tandy 1000 TX and a Model 102. And now, if you don't mind, perhaps we could see the scene of the crime?"

"Certainly, Mr. Holmes. Come this way, gentlemen."

We followed Mr. Ube to an elevator and presently found ourselves on the 15th floor of One Tandy Center. A great deal of construction was evident.

"Please excuse the mess — we're recarpeting mahogany row. It will be done shortly. This is the office of John Ochra, *capo de capo*."

"I see you are familiar with Italian, Mr. Ube."

"My mother's side of the family, Mr. Holmes."

"Ah, yes. Northern Sicily, I believe, about 40 kilometers from Palermo. The daughter of a wine merchant, I would say."

The executive expressed great surprise. "Why, Mr. Holmes! How could you have known that?"

"Tut, tut, Mr. Ube. I wrote a short monograph on Italio-Japanese accents some time ago. Pray continue."

"Mr. Ochra was sitting at his desk that night, reviewing our new Color Computer product — which, I'm sorry, I can't say much about, Mr. Holmes."

"Other than the fact that it runs at 20 MHz, uses a 68020, is multitasking, has 1,024-by-1,024 screen resolution with a palette of 1,024 colors, has a built-in, 80-megabyte disk drive, and sells for under \$200 with monitor, neither can I, Mr. Ube," remarked Holmes. "I quite understand. Propriety is the lifeblood of computer companies these days."

The executive turned several colors never seen on a Color Computer and hesitantly continued.

"The product is defined in a 100-page specification marked TOP SECRET. Only two copies exist, and Mr. Ochra was reading one of them."

"Where is the other?"

"Locked quite securely in Mr. Ochra's safe. He verified that shortly after the theft.

"It was quite late, and Mr. Ochra was the only person on the floor. Leaving the document on the desk, he went downstairs to get some refreshment. However, hardly had he left the elevator on the first floor when he noticed by the control panel that a second elevator was stopping on the 15th floor. He immediately boarded the elevator and pressed the 15th floor button. When he arrived on the floor and reached his desk, he found, to his horror, that the document was gone. In its place was this note."

Holmes looked briefly at the note. It read:

Tandy, are you happy, really happy, you are Tandy?

Gil B. Ube

"As you can see by the note, Mr. Holmes, it was signed by me! And in my handwriting."

"I would not have expected less."

"Does it mean anything to you, Mr. Holmes?"

"Yes, I believe it does. May I keep this?"

"Please do."

"Tell me, Mr. Ube, had Mr. Ochra observed anyone else on his floor before that time?"

"Only a cleaning woman and a security guard. The cleaning woman arrived at 6 o'clock p.m. and left at 6:30. The security guard passed through briefly at 7:05 p.m., shortly before the theft."

"Mr. Ube, I believe I can find the answer. Might I impose upon you to borrow some computer equipment? I neglected to bring along my Model 102."

"Certainly, Mr. Holmes. Would a Color Computer 3 disk system be sufficient?"

"That will do splendidly, Mr. Ube. Might I also borrow a list of your employees? One with their names and job classifications will do nicely."

"We'll have the list for you in a moment, Mr. Holmes."

I did not see Holmes for the rest of the day. However, later in the evening, my telephone rang.

"Watson, come here, I need you," said Holmes' voice.

You may have the wrong Watson, I thought to myself, but answered, "On my way, Holmes!"

I hurried over to Holmes' room and knocked. When he opened the door I was amazed to find the room in great disarray. The bed was overturned, the Color Computer 3 equipment was in a jumbled mess on the floor, the room lamp was smashed, and papers were strewn about everywhere.

"Holmes, what happened?" I shouted, aghast.

"He's been here, Watson — my old nemesis. I left the room

DMC "No Halt" Disk Controller

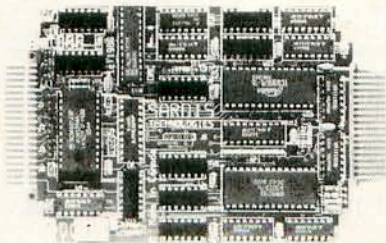

Did you know?

... that all the older floppy disk controllers for the CoCo completely tie up (and even halt) the 6809 processor during disk reads and writes? No wonder your keyboard is constantly "losing" characters! Or that your serial port often gives you garbage.

Unleash your CoCo's potential!

Our new Dual Mode Controller (DMC) implements a new "no halt" mode of operation so it can read from or write to disk all by itself. The 6809 is freed to process other tasks and respond to interrupts. This is how OS-9 was meant to run! But the Radio Shack "halt" mode of operation is also retained to maintain full compatibility with existing non-OS-9 software.

Free! Disk caching software included can speed up OS-9 disk accesses.



SARDIS
TECHNOLOGIES

2261 East 11th Ave., Vancouver, B.C., Canada V5N 1Z7

Other DMC features:

- works with original CoCo, CoCo 2, or CoCo 3 (Multi-Pak required)
- no adjustments — all-digital data separator and write precompensation
- gold plated card-edge connectors for reliability
- ROM socket takes 24 pin or 28 pin chip; dual DOS capability
- Radio Shack DOS 1.1 ROM installed
- 8K bytes cache memory on board (32K optional)
- D.P. Johnson's SDISK package (specially modified for DMC) is included at no charge (\$30 value)
- aluminum case
- fully assembled and tested; 120 day limited warranty

To order: DMC controller with RSDOS 1.1 and SDISK (specify OS-9 Level I or II) \$149.50 plus \$5 S/H (\$12 overseas). Add \$16 for 32K RAM option. Terms (prices in \$US); check, money order, VISA. U.S.A. orders shipped via UPS from WA state.

(Also ask about our ST-2900 6809 based expandable single board computer)

(604) 255-4485 (Pacific Time)



Fill out your CoCo library with these selections

The Complete Rainbow Guide to OS-9

Authors Dale Puckett and Peter Dibble show how to take advantage of OS-9's multitasking and multiuser features. An easy-to-read, step-by-step guide packed with hints, tips, tutorials and free software in the form of program listings.

Book \$19.95, Disk Package \$31 (2 disks, book not included)

The Windows and Applications Disk for The Complete Rainbow Guide to OS-9 Level II, Vol. I

Puckett and Dibble have done it again! Here are all the great programs from the first volume of the Level II guide. Clever new applications ready to run. Disk \$19.95

The Rainbow Introductory Guide to Statistics

Dr. Michael Plog and Dr. Norman Stenzel give a solid introduction to the realm of statistical processes and thinking for both the beginner and the professional. (80-column printer required.)

Book \$6.95, Tape or Disk \$5.95, Package \$11.95

The First Rainbow Book of Adventures

Contains 14 winning programs from our first Adventure contest. Includes *Sir Randolph of the Moors*, *Horror House*, *One Room*, *Dr. Avaloe* and more. Plus hints, tips on solving Adventures.

Book \$3.50, Tape \$3.50

The Second Rainbow Book of Adventures

Featuring 24 of the most challenging Adventure games ever compiled. Meet the Beatles and battle the Blue Meanies, find a hidden fortune, or win the heart of a mysterious princess. *Ring Quest*, *Secret Agent Man*, *Dark Castle*, *Curse of Karos* and more!

Book \$13.95, Tape \$13.95

The Third Rainbow Book of Adventures

The excitement continues with 19 new Adventures. Discover backstage intrigue at the London Theatre, attempt a daring space rescue, or defeat evil in the year 2091 as a genetic android. *Evil Crypt*, *Spymaster*, *Time Machine*, *The Amulet*, and that's only the beginning! Book \$11.95, Tape \$9.95, Two-Disk Set \$14.95

The Rainbow Book of Simulations

20 award-winning entries from THE RAINBOW's first Simulations contest. You are a Civil War Commander, an air traffic controller, a civil defense coordinator, or a scientist on Mars . . . your wits are on the line.

Book \$9.95, Tape \$9.95

The Second Rainbow Book of Simulations

The 16 winners from our second Simulations contest. Fly through dense African jungle, bull your way down Wall Street, lead a bomb squad, or try your hand at Olympic events. Test your skills and talents. Book \$9.95, Tape \$9.95, Disk \$10.95

I want to start my own Rainbow Bookshelf!

Name _____

Address _____

City _____

State _____ ZIP _____

Payment Enclosed, or Charge to:

VISA MasterCard American Express

Account Number _____

Card Expiration Date _____

Signature _____

Please send me:

- The Rainbow Book of Simulations \$ 9.95 _____
- Rainbow Simulations Tape \$ 9.95 _____
- The Second Rainbow Book of Simulations \$ 9.95 _____
- Second Rainbow Simulations Tape \$ 9.95 _____
- Second Rainbow Simulations Disk \$10.95 _____
- The Complete Rainbow Guide to OS-9 (book only) \$19.95 _____
- Rainbow Guide to OS-9 Disk Package (2 disks) \$31.00 _____
- The Windows & Applications Disk for
The Complete Rainbow Guide to OS-9 Level II, Vol. I \$19.95 _____
- The Rainbow Book of Adventures (first) \$ 7.95 _____
- Rainbow Adventures Tape (first) \$ 7.95 _____
- The Second Rainbow Book of Adventures \$13.95 _____
- Second Rainbow Adventures Tape \$13.95 _____
- The Third Rainbow Book of Adventures \$11.95 _____
- Third Adventures Tape \$ 9.95 _____
- Third Adventures Disk Set (2 disks) \$14.95 _____
- Introductory Guide to Statistics \$ 6.95 _____
- Guide to Statistics Tape or Disk (indicate choice) \$ 5.95 _____
- Guide to Statistics Package (indicate choice of tape or disk) \$11.95 _____

Add \$1.50 per book Shipping and Handling in U.S.

Outside U.S., add \$4 per book

Kentucky residents add 5% sales tax

(Allow 6 to 8 weeks for delivery)

Total _____

Mail to: Rainbow Bookshelf, The Falsoft Building, P.O. Box 385, Prospect, KY 40059

To order by phone (credit card orders only) call (800) 847-0309, 8 a.m. to 5 p.m. EST. For other inquiries call (502) 228-4492.

Please note: The tapes and disks offered by The Rainbow Bookshelf are not stand-alone products. That is, they are intended to be an adjunct and complement to the books. Even if you buy the tape or disk, you will still need the appropriate book. OS-9® is a registered trademark of the Microwave Systems Corporation.

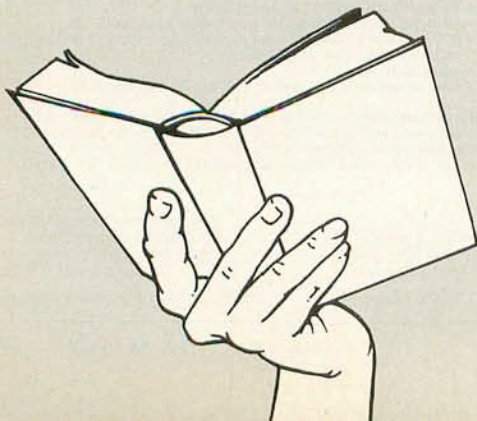

for a brief moment to buy a copy of the *London Times* in the lobby. When I got back, I was greeted by this."

"Holmes, who has been here?"

"Moriarty, Watson. I have proven beyond a reasonable doubt that Moriarty has been undermining computer companies. Tandy is his latest effort. Help me get this room and computer equipment in order. In the meantime, please telephone Mr. Ube and have the Fort Worth police detain a Mr. James Y. Marriot."

I did as Holmes bid. However, I was informed by Mr. Ube that Mr. Marriot was nowhere to be found. He had disappeared shortly after lunch.

"Watson, I'm afraid that once again I have been too late to stop Moriarty. But possibly I can repair some of the damage he has done to Tandy. Please call Mr. Ube and have him assemble Tandy's executives."

I placed the call as Holmes requested. All conversation ceased as Holmes strode into the room, a Color Computer system under his arm.

"Gentlemen, how kind of you to come. Please forgive my delay in setting up this system."

Holmes set up the Color Computer and disk drive, and inserted a disk from his pocket. He stepped back and addressed the crowd.

"As some of you know, I have been a longtime admirer of Tandy computer products. I was therefore interested when I received this letter from your Mr. Ube.

"Something about the nature of the crime reminded me of recent events in American computer companies. I was immediately convinced that your Mr. Ube was not the criminal. Following that logic, I used a list of names of your

current employees for processing by one of your wonderful machines. Let me show you what I mean."

Holmes turned to the Color Computer and loaded a BASIC program.

"This program will take any characters entered and shuffle them around to make new words or phrases. This type of rearrangement is called an anagram. Only the letters used in the original words or phrases are used. Let's take the name James Y. Marriot, from the man whom I understand is not at this meeting because he has disappeared. When the letters j-a-m-e-s-y-m-a-r-r-i-o-t are entered into this program, the computer will rearrange the letters in all possible permutations.

"One question that may spring to mind is in regard to the number of permutations. Suppose we had two letters — call them *a* and *b*. There are only two arrangements of these letters — *ab* and *ba*. Now suppose we had three letters *a*, *b* and *c*. We could have *abc*, *acb*, *bac*, *bca*, *cab* and *cba*, a total of six in all. If we used the letters in Mr. Marriot's name, we would have 13 letters with which to work. There are 13 choices for the first letter, 12 choices for the second letter — as one letter has been used from the pool of 13 letters — 11 choices for the third letter, and so on, down to one choice for the last letter. In fact, there are

$$13 \times 12 \times 11 \times 10 \times 9 \times 8 \times 7 \times 6 \times 5 \times 4 \times 3 \times 2 \times 1$$

choices, or over 6,227,020,800 rearrangements! There's a name for this formula; it's called *factorial*. You'll find the factorial symbol (!) used a great deal in higher mathematics, as I'm sure some of you are aware, with the possible exception



It's fun making your own Greeting Cards, Signs, and Banners.

Coco Graphics Designer Only \$29.95

Requirements: a Coco I, II or III with at least 32K, one disk drive, BASIC 1.0/1.1, ADOS 1.0/1.1 or JDOS. Printers supported include: Epson RX/FX, Gemini 10X, SG10, NX10, DMP 100/105/110/130/430 CGP220, many Okidata (check with Zebra), Seikosha GP100/250, Gorilla Banana, Legend 808. Order #C323 Coco Graphics Designer

Picture Disk #1

This supplementary picture library diskette contains over one hundred additional pictures.

#C333 Picture Disk #1 \$14.95

Colored Paper Packs

150 sheets (50 each red, yellow, blue) with 60 matching envelopes. Perfect for making your productions outstanding.

#C274 Paper Pack \$19.95

Get a FREE Custom Car Sign

Send us the wording, from 1 to 4 lines of text of your choice, and we'll print it out on bright yellow paper using the CoCo Car Sign Designer, put it into a reusable clear plastic sign holder with suction cup, and mail it to you. Please send a check for \$3.00 to cover S&H unless accompanying an order.



WICO TRACKBALL Only \$29.95

Order Cat#TBCC

WICO designed these trackballs specifically for the Radio Shack Color Computer joystick port. They feature 360-degree movement and quick-action fire button for smooth, arade response and feel. Works great with Coco joystick and mouse software.

Ordering Instructions: All orders add \$3.00 Shipping & Handling. UPS COD add \$3.00. VISA/MC Accepted. NY residents add sales tax.

Zebra Systems, Inc.
78-06 Jamaica Ave.
Woodhaven, NY 11421
(718) 296-2385



The Car Sign Designer program enables you to easily create distinctive bright yellow diamond shaped car signs. Everything you need is provided including two reusable clear plastic sign holders with suction cups, 50 sheets of bright yellow fanfold paper, and the Car Sign Designer program disk and instructions. ... Hardware, DOS, and printer requirements are the same as for our CoCo Graphics Designer. Order Cat#CSCC, \$29.95. For six additional sign holders, order Cat#CS6PK \$9.95.

of the marketing people. However, in Mr. Marriot's name, the *a* and *r* repeat, so the actual number is somewhat less.

"The programme here lists all of these combinations, but I soon realized that it would take over 197 years at one combination per second. I then modified the programme to simply help in decoding anagrams. The user first enters the entire list of letters, and then enters a word or words. The programme makes certain that the words are in the common pool of letters and then lists all remaining letters in different combinations.

"Now watch what happens when I put in the letters *j-a-m-e-s-y-m-a-r-r-i-o-t* and then the word *james*. The remaining letters *y-m-a-r-r-i-o-t* are used to form 8! words, 40,320 arrangements in all. The 21,233rd arrangement is *M-O-R-I-A-R-T-Y*, a man well-known by me, a master computer criminal and hacker, and skilled in the binomial theorem. I will not run through all of them, gentlemen, but you undoubtedly get the idea.

"Mr. Marriot is employed as a security guard, and is one of the people who had access to the 15th floor without creating any suspicions whatsoever. I understand, however, that Mr. Marriot has now disappeared."

"Do you mean to say that Marriot is the thief, Mr. Holmes?" asked Mr. Ube.

"Not only is he the thief, but he has systematically undermined several computer companies in the course of his career in the last 10 years. It was he who was responsible for the demise of the Timex Computer Division by its late introduction of the Timex 2068. It was he who introduced delays in the Osborne MS-DOS machine. It was he who was instrumental in the firing of Steven Jobs at Apple. He went under a variety of names in these companies, but he could not resist flaunting his anagrammatic talent — they were all anagrams of James Moriarty — James Y. Tramori, Jamie Trysmora, James Y. Armorit, and others.

"At Tandy he was working his evil ways in the safe guise of a security guard. As a guard, he had access to all areas. And with his extensive knowledge of computers, he could easily alter company memoranda, change design specifications, or perform other acts designed to sabotage even a well-run company such as Tandy. We can only hope that he was not able to work too much damage.

"My suspicions about Mr. Marriot were confirmed when I saw the note he had left in place of the manuscript. Recall that it was signed by Mr. Ube:

Tandy, are you happy, really happy, you are Tandy?

Gil B. Ube

"This is a *sentence* palindrome — a sentence that reads the same forward or backward. It was Moriarty's final signature."

"But, Mr. Holmes, where is Moriarty now?" asked Mr. Ube.

"I expect he'll show up at Dell Computer, or Apple, or Atari, and undoubtedly in a disguise created by the surgeon's knife."

"But why does he attempt to destroy computer companies?"

"His employer dictates it."

"His employer?"

"Come, come, Mr. Ube. His employer was the reason he was able to use your name on the document. If you transpose your signature in an anagram, you'll see what I mean."

Mr. Ube thought for a moment and wrote on a convenient pad. "Oh, *that* company!" he exclaimed.

"Mr. Holmes, we don't know how to thank you. It's just unfortunate that Moriarty saw the specifications for our new computer."

"But he didn't, Mr. Ube."

"What do you mean, Mr. Holmes?"

"Moriarty made a thorough search of my room at the hotel. There was no reason for him to search my room unless he thought I had a copy of the plans. Fortunately, Mr. Ochra interrupted Moriarty's theft just in time. Remember that the document was in a bright red cover with TOP SECRET marked in bold letters. Even his fellow security guard in the downstairs lobby would notice the bulky document. Instead, he decided to hide the document and come back to retrieve it at a later time. He actually discarded it in his mad dash away from Mr. Ochra's office."

"But why wasn't he able to retrieve it, Mr. Holmes?"

"By a fortunate coincidence, the floor was undergoing remodeling, and the document was taken away the next day, together with the other documents with which it was stored. They were returned only today, and by then, he was discovered. Unless I miss my guess, gentlemen, you'll find it in that bookcase over there."

Several of the executives hurried over to the bookcase, which was crowded with multi-colored documents.

"Here it is!" exclaimed one.

"And so, Mr. Ube, I trust you will be more careful about security men in the future?" Holmes exclaimed as he took the proffered check and airline tickets. "Come, Watson, we have just time for a meal at Joe T. Garcia's before the Concorde departs."

* * *

Palindrome Program

The palindrome program in Listing 1 allows you to enter a string of characters, words or sentences and test whether what you've entered is a character palindrome — a word, phrase or sentence that has the same characters backward and forward. Spaces and punctuation are automatically discarded. For example, the exchange in entering the palindromic sentence "Draw, O Caesar, erase a coward!" would look like this:

```
WORDS: DRAW, O CAESAR, ERASE A COWARD !
PALINDROME-BOTH STRINGS ARE
DRAWCAESARERASEACOWARD
WORDS: _
```

If the characters do not form a palindrome, both the original and reverse are printed for comparison:

```
WORDS: RATS LIVE ON NO EVEL STAR
NO PALINDROME
ORIGINAL :RATSLIVEDONNOEVELSTAR
REVERSE :RATSLEVEDONNOEVELSTAR
WORDS:
```

The program will run on any CoCo with Extended BASIC. Characters should be entered in uppercase.

Letter Count Program

The letter count program in Listing 2 breaks down characters, words, phrases or sentences into the number of letters, arranged in sequence. This can be helpful in making up words for palindromes or anagrams. It's always interesting

to note the large number of vowels in both palindromes and anagrams. Note the following:

WORDS: MADAM, I 'M ADAM!
 AAAA
 DD
 I
 MMMM
 WORDS: _

The program will run on any CoCo with Extended BASIC, and, again, characters should be in uppercase, but spaces and punctuation can be used.

Permutations Program

The permutations program in Listing 3 lists all permutations of from two to 10 letters. Sherlock Holmes used a BASIC09 version of this program in an earlier story ("The Mystery of the Novice Bell Ringer," November 1987, Page 174). The program there was a recursive program that called itself. Recursion is not possible in Extended BASIC (without a good deal of trouble, that is), but the program in Listing 3 will handle up to 10 letters. Permutations of two letters are AB and BA (1*2). Permutations of three letters are ABC, ACB, BAC, BCA, CBA and CAB (1*2*3). There are 24 permutations of four letters (1*2*3*4), 120 permutations of five letters (1*2*3*4*5), 720 permutations of six letters, 5,040 permutations of seven letters, 40,320 permutations of eight letters, 362,880 permutations of nine letters, and 3,628,800 permutations of 10 letters. The seven-letter case displays in about 15 minutes, but you can see that the cases involving a larger number of letters are not too usable.

A partial list of the anagrams of the letters in the word BARDEN are displayed as follows:

WORDS: BARDEN
 BARDEN BARDNE BAREND BAREDN . . .

BARDEN yields names I had never thought of, like BRENDA and the dubious BARNED, and also combinations from which palindromes could be made.

The program works by a series of nested calls to eight routines. At the bottom, the routine switches the last two letters of the current string. For example, XXXXAB would be switched to XXXXBA. Two swaps are made to restore XXXXAB to the original. The routine above calls this routine three times, thus rotating three letters with two rotations of two letters for each call. For example, XXXABC would be changed to XXXBCA and then two calls would be made to the lower routine for XXXBAC and XXXBCA; the letters would then become XXXCAB, with two calls for XXXCBA and XXXCAB; the letters would then become XXXABC, with two calls for XXXACB and XXXABC. With each shift to the left, one more letter must be rotated, and subsequent calls are made to the lower routines.

Like the previous programs, spaces and punctuation are discarded before the display is done. The ON LEN(A\$) statement branches out to the proper level based upon the length of the input string.

The rotate subroutine performs a left rotation of all or a portion of the word. For example, if the subroutine is called with J=5 and the letters are ABCDEFGH, the subroutine will set J equal to LEN(A\$) - 5 = 8 - 5 = 3 and produce ABC plus the left rotation of DEFGH, EFGHF. The result will be

TANDY COMPUTER DISCOUNTS

COLOR COMPUTERS

26-3334 CoCo 3	170.00
26-3215 CM-8 color monitor	259.95

PRINTERS

26-2802 DMP 106	179.95
26-2808 DMP 440	599.00
26-1280 DMP-130	279.00
Complete line of Tandy (Daisy Wheel) print wheels	

MSDOS COMPUTERS

25-1052 Tandy 1000 SX	750.00
25-1053 TANDY 1000 HX	599.00
25-1600 TANDY 1000 TX	999.95
25-1023 CM-5 color monitor	249.95
25-1020 VM-4 Monochrome monitor	110.00

We Carry the Complete Line of Tandy Computer Products at Discount Prices

**CALL FOR A FREE PRICE LIST 800-257-5556
 IN N.J. CALL 609-769-0551**

WOODSTOWN ELECTRONICS

Rt. 40 E. WOODSTOWN, N.J. 08098

CINSOFT

PROGRAMS • PERIPHERALS • SUPPLIES • SERVICE

Fast Delivery...
 Friendly Service



Now in our 6th year!

Avatex Modems

SUPER VALUE!

Avatex 1200e \$ 99
 with Coco Cable 109

Reviewed in
 April, 1988
 Rainbow!



Avatex 1200e, Cable
 AUTOTERM ... \$139



SUPER SPEED!

Avatex 2400 \$219
 with Coco Cable 229
 (Coco 3 only)
 with RS-232 Cable* 245

Avatex 2400, Cable
 AUTOTERM ... \$259

*Coco 1, 2 requires Deluxe RS-232 Pak

• Call •

513-396-SOFT

• Shop by Modem •

513-396-SHOP



2235 Losantiville, Cincinnati, OH 45237

SHIPPING will be charged at our ACTUAL COST
 Ohio residents add 5.5% Sales Tax COD add 2.50

ABCEFGH. For a word of six letters, the subroutine is called 720 times.

FREEWALL for now. See you next month with more CoCo topics.

Listing 1: PALINDRM

```
100 ' PROGRAM TO REVERSE STRING
TO CHECK FOR PALINDROMES
110 CLEAR 2000
120 CLS
130 LINE INPUT "WORDS: "; WD$
140 B$ = ""
150 FOR I = 1 TO LEN( WD$ )
160 A$ = MID$( WD$, I, 1 )
170 IF ( A$ > CHR$( 64 ) ) AND (
  A$ < CHR$( 91 ) ) THEN B$ = B$
+ A$
180 NEXT I
190 C$ = ""
200 FOR I = LEN( WD$ ) TO 1 STEP
-1
210 A$ = MID$( WD$, I, 1 )
220 IF ( A$ > CHR$( 64 ) ) AND (
  A$ < CHR$( 91 ) ) THEN C$ = C$
+ A$
230 NEXT I
240 IF B$ = C$ THEN PRINT "PALIN
DROME-BOTH STRINGS ARE ": PRINT
B$
250 IF B$ <> C$ THEN PRINT "NO P
ALINDROME": PRINT "ORIGINAL: "; B
$:PRINT "REVERSE: " C$
260 GOTO 130
```

Listing 2: LETTERS

```
100 ' PROGRAM TO COUNT NUMBERS O
F LETTERS
110 CLEAR 2000
120 DIM L( 26 )
130 CLS
140 LINE INPUT "WORDS: "; WD$
150 FOR I = 0 TO 25: L( I ) = 0:
NEXT I
160 FOR I = 1 TO LEN( WD$ )
170 A$ = MID$( WD$, I, 1 )
180 IF ( A$ > CHR$( 64 ) ) AND (
  A$ < CHR$( 91 ) ) THEN L( ASC(
A$ ) - 65 ) = L( ASC( A$ ) - 65
) + 1
190 NEXT I
200 FOR I = 0 TO 25
210 IF L( I ) <> 0 THEN FOR J =
1 TO L( I ): PRINT CHR$( I + 65
);: NEXT J: PRINT
220 NEXT I
230 GOTO 140
```

Listing 3: PERMS

```
100 ' PROGRAM TO LIST ALL PERMUT
ATIONS OF A PHRASE
```

```
110 CLEAR 2000
120 PRINT
130 LINE INPUT "WORDS: "; WD$
140 A$ = ""
150 FOR I = 1 TO LEN( WD$ )
160 B$ = MID$( WD$, I, 1 )
170 IF ( B$ > CHR$( 64 ) ) AND (
  B$ < CHR$( 91 ) ) THEN A$ = A$
+ B$
180 NEXT I
190 ON LEN( A$ ) GOTO 190,360,34
0,320,300,280,260,240,220,200
200 FOR K = 1 TO 10: GOSUB 220:
J = 10: GOSUB 380: NEXT
210 END
220 FOR L = 1 TO 9: GOSUB 240: J
= 9: GOSUB 380: NEXT
230 IF LEN( A$ ) = 9 THEN GOTO 1
20 ELSE RETURN
240 FOR M = 1 TO 8: GOSUB 260: J
= 8: GOSUB 380: NEXT
250 IF LEN( A$ ) = 8 THEN GOTO 1
20 ELSE RETURN
260 FOR N = 1 TO 7: GOSUB 280: J
= 7: GOSUB 380: NEXT
270 IF LEN( A$ ) = 7 THEN GOTO 1
20 ELSE RETURN
280 FOR O = 1 TO 6: GOSUB 300: J
= 6: GOSUB 380: NEXT
290 IF LEN( A$ ) = 6 THEN GOTO 1
20 ELSE RETURN
300 FOR P = 1 TO 5: GOSUB 320: J
= 5: GOSUB 380: NEXT
310 IF LEN( A$ ) = 5 THEN GOTO 1
20 ELSE RETURN
320 FOR Q = 1 TO 4: GOSUB 340: J
= 4: GOSUB 380: NEXT
330 IF LEN( A$ ) = 4 THEN GOTO 1
20 ELSE RETURN
340 FOR R = 1 TO 3: GOSUB 360: J
= 3: GOSUB 380: NEXT
350 IF LEN( A$ ) = 3 THEN GOTO 1
20 ELSE RETURN
360 FOR S = 1 TO 2: J = 2: PRINT
  A$, : GOSUB 380: NEXT
370 IF LEN( A$ ) = 2 THEN GOTO 1
20 ELSE RETURN
380 ' SUBROUTINE TO ROTATE PORTI
ON OF WORD
390 ' ENTER WITH J=# OF LETTERS
IN GROUP
400 ' ENTER WITH A$=WORD
410 ' EXIT WITH A$=ROTATED WORD
420 J = LEN( A$ ) - J
430 B$ = RIGHT$( A$, LEN( A$ ) -
  J )
440 B$ = RIGHT$( B$, LEN( B$ ) -
  1 ) + LEFT$( B$, 1 )
450 A$ = LEFT$( A$, J ) + B$
460 RETURN
```

DISTO

SUPER PRODUCTS

INTRODUCES

THE FANTASTIC SUPER CONTROLLER II

POWER BEYOND BELIEF



- Radio Shack/Tandy controller compatible.
- Works on all COCOs! 1, 2 or 3, with or without Multi-pak interface.
- One 24/28 pin socket, for 8K ROM, 2764, 27128 or 27256.
- Internal Mini-Expansion-Bus Connector for one DISTO Super Adapter board.
- Low Power draw; Within COCO's power requirements.
- Gold Plated edge connectors.
- Under OS-9:
 - Buffered Read/Write sector achieved without halting the CPU.
 - Continual use of keyboard even while Reading or Writing to disk.
 - System's Clock no longer loses time during Read & Write.
 - NMI is blocked and transferred to IRQ in software for low CPU overhead.
 - Completely Interrupt driven for fast and smooth Multi-Tasking operations.
 - Drivers (written by Kevin Darling) for Level 1 and 2.

Suggested Retail Price

\$150

Introductory Price \$130

DISTO SUPER CONTROLLER I \$99.95



A superb controller. Along with the included C-DOS, plug-in three more software selectable 2764 or 27128 EPROMs burned to your liking.

The internal Mini Expansion Bus lets you add some incredible features to the controller. Disto Super Add-Ons were designed to fit neatly inside the Super Controller case.

DISTO SUPER RAM 3 **Zero K** \$ 29.95 **Full 512K** 109.95

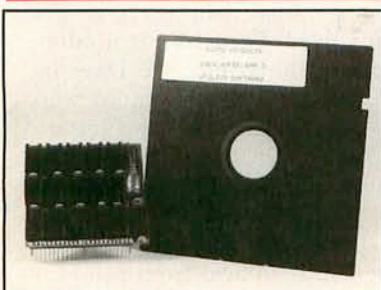

Now is the time to upgrade your COCO 3 to 512K of memory. Available with or without memory chips, the **Super Ram 3** board is easily installed inside the COCO. It is fully compatible with OS-9 Level 2 and is delivered with a software package (for BASIC) that includes: a printer spooler, a ramdisk, a memory test and an install/configure program for your system.

DISTO SUPER ADD-ONS

REAL TIME CLOCK AND PARALLEL PRINTER INTERFACE
Have the Real Time, date and year displayed on your screen at a simple command. **\$39.95**

MINI EPROM PROGRAMMER
A low cost EPROM programmer that attaches directly to your Disto Super Controller to program those often used utilities. **\$54.95**

HARD DISK INTERFACE
A hard disk interface fully compatible with S.A.S.I. controller. Fits inside the Super Controllers, Ramdisk or MEB adapter. OS-9 Drivers are included. **\$49.95**

SUPER RAMDISK 512K
Imagine having access to 512K of virtual disk memory in close to no time. Upgradable to One Megabyte **\$119.95**

MEB ADAPTER
A Stand-Alone Mini-Expansion-Bus in which you can plug any other DISTO Adapter directly in a Multi-pak without the need for a Super Controller or Ramdisk **\$24.95**

SEND FOR FREE 1988 SPRING CATALOG

CRC COMPUTERS inc.

10802 Lajeunesse, Montreal, Quebec, Canada, H3L 2E8

MASTER CARD
AND VISA
ACCEPTED

1-514-383-5293

We accept phone orders.
Call for Canadian prices.

Include S&H of \$4 or \$8 if order exceeds \$75.

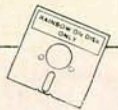

KISSable OS-9

Patches, Programs and Politics

By Dale L. Puckett
Rainbow Contributing Editor

Things are looking up. One day last week I received a new issue of *MOTD* from the OS-9 Users Group. The next day the mailman brought *Home Publisher*, Tandy's new desktop publishing program for the Color Computer 3. During the weekend, I started using an alpha test copy of *Wiz2* from Bill Brady, and I had time to dive into Computerware's fantastic window-based database manager, *Data Master*.

Dave Kaleita, the OS-9 Users Group's take-charge president, is really getting the group moving. The new 12-page *MOTD* looks great, thanks to Editor Bill Brady's skills with the *Ready Set Go* desktop publishing program. It's printed on 8-by-10 paper and can easily be saved in a three-ring binder. A ballot printed on Page 11 of *MOTD* gives you a chance to vote for a new slate of officers.

Brady writes that he is "downright excited." He expects many new OS-9 users in the near future and predicts that OS-9 is quickly coming out from "underground." He cites the fact that Personal OS-9 is now available for the Atari ST, which runs a 68000 processor.

Dale L. Puckett, who is author of The Official BASIC09 Tour Guide and co-author, with Peter Dibble, of The Complete Rainbow Guide to OS-9, is a free-lance writer and programmer. He serves as director-at-large of the OS-9 Users Group and is a member of the Computer Press Association. Dale is a U.S. Coast Guard lieutenant and lives in Rockville, Maryland.

He also notes that OS-9 Level II on the Color Computer is just about the most effective, mature operating system available in the personal computer world.

Brady passed kudos to Microware for picking up the pieces of the Atari ST port after TLM Systems dropped it. The ST port marks the first time Microware, having dealt only with large companies like Tandy, has sold operating systems directly to the public. In fact, Microware now runs its own SIG on CompuServe to help its customers. Just type GO MSC for help.

Here's a tip you may find handy if you, like Brady, own several different computers — or use a different computer at the office — and want to transfer graphics images between them. When you type GO PICS on CompuServe, you enter a SIG designed to let you exchange pictures with anyone using any computer. Utilities are posted there that let you translate a graphics file created on your Color Computer into a .GIF file.

The idea is to convert your image into a .GIF file and upload it to the PICS SIG where other computer users can download it and display it on their screens. For example, if a Macintosh user saw a CoCo image and wanted to print it in a newsletter, he would run a utility designed to translate the .GIF file into a *MacPaint* file and then upload it.

This is precisely how Brady was able to print several screen images of *Multi-View* in his first *MOTD*. Kevin Darling saved the images in the familiar .VEF format and then ran one of the utilities to convert them to .GIF files. He sent them to Brady in the .GIF format, and

Bill used the .GIF-to-*MacPaint* utility to convert them to a file he could pour into *Ready Set Go*. Magic.

While we're on the subject of *MOTD*, Kaleita says he hopes the present issue generates enough membership renewals that he will be able to have Brady publish one every other month. The OS-9 Users Group's address is Suite R-237, 1715 East Fowler Ave., Tampa, FL 33612. Inexpensive access to the group's outstanding public domain software library is worth the price of admission — \$25 for one year's dues. *MOTD* is a bonus, a valuable and nice-looking one at that.

Since Kaleita has assumed command, things have really started to happen with the Users Group. In fact, this past weekend I had the pleasure of joining the Users Group's elected officers in a conference on RAINBOW's Delphi OS-9 Online SIG. Like any good leader, Kaleita has delegated many of the tasks of the organization to his board of directors. And he's given his troops enough responsibility to get the job done.

Perhaps you would like to get involved. Kaleita's officers hope so. In fact, during the conference they spent more than several minutes trying to figure out a way to make it possible for the group's many volunteers to get directly involved. For additional information about the group, see Dave or George Dorner — and who knows who else will show up — at the Chicago RAINBOWfest. Or, drop a quick note to any of the officers on the Delphi OS-9 Online SIG; their usernames are OS9UGP, OS9UGVP, OS9UGS and OS9UGE. They'll be happy to hear from you.

Wiz2 on the Horizon

Wiz2, from Bill Brady, promises to be one of the best communications programs on any microcomputer. I have tried both *Red Ryder* on the Macintosh and *ProComm* on the IBM PC. Both are outstanding products and lead the pack on their machines, but *Wiz2* offers more functionality and ease of use than both of these programs.

Wiz2 is an advanced communications program for users with special needs, yet it's the easiest terminal program to install and run on an OS-9 based Color Computer 3. Not bad for a product that was born for only one reason — to demonstrate to software developers and OS-9 users alike the gargantuan programming power lying dormant in BASIC09.

Wiz2's esthetic appeal is made possible by the windowing system built into OS-9 Level II, easily accessible from BASIC09. The interactive nature of BASIC09 lets Brady deliver his masterpiece quickly. Its modularity lets him build the program from a number of small modules that are relatively easy to write and maintain.

Here's the good news! When *Wiz2* is released sometime this summer, the original *Wiz* will not be taken off the market. If you buy *Wiz* before *Wiz2* is released, you will be able to upgrade to *Wiz2* at a small cost by using the coupon found inside the original *Wiz* manual. This means you don't have to wait for *Wiz2* to experience the *Wiz* communications environment. Once you've used the friendly, menu-driven, window-based *Wiz*, you'll never want to go back to a command line-oriented communications program.

The alpha test version of *Wiz2* that we are running now has a two-line billboard and status window along the top of the screen. A single line at the bottom of the screen gives you status information during a file transfer and takes your input if you go into conference mode — or go online temporarily while "editing" your data buffer.

"Buffer editor" is probably not the right name for a new feature that puts *Wiz2* miles ahead of the competition. Yet neither Brady nor Kevin Darling could think of a good name to describe it. In fact, I couldn't think of a name either, but let's take a look.

When you hold down the ALT key and strike the up arrow key, *Wiz2* opens a new 12-line overlay window and displays some of the text you have been receiving. You can use the up and down arrow keys to scroll through the last

8,000+ characters received in your buffer. If you find something you want to save or print, you can mark it and send it to the printer or take a snapshot and send it to your disk.

Here's a list of *Wiz2* "buffer editor" commands:

- q quit
- t mark top
- b mark bottom
- f find
- g goto
- e eject page
- z reset — or unmark text
- s snap marked text to disk
- p send marked text to printer
- o go online

A typical scenario might read like this. You see a message scroll by that you want to save for future study. After you finish the task you were already busy with when the message displayed on the screen, you press ALT and the up arrow to work in your edit buffer. You quickly find the message by pressing F. Seconds after you press ENTER, *Wiz2* displays the line that contains your subject

You then strike the up arrow key to move to the top of the message. When the cursor arrives on the first line, press T to mark the top. Then use the down arrow key to move to the last line of the message. As you move through the buffer, the text that you pass is highlighted. When you arrive at the last line of the message, and it is highlighted, press B for bottom. Then press P and a copy of the message is sent to the printer. A Q closes the overlay window and puts you back online normally.

If you need to go online and make a quick comment while working within the buffer, you can press O for online. When you do this, *Wiz2* displays online copy in the two-line status window at the top of the screen and accepts input from you on the single-line window at the bottom of the screen.

I hooked up my CoCo 3 with *Wiz2* to an amateur radio receiver connected to a packet radio terminal monitoring a DX tracking network and set out to test *Wiz2*. It worked like a charm, but I quickly dreamed up a "wish list" and gave Brady a call. We kicked around some ideas, and he's working on them now. That's one of the reasons he hasn't committed himself to a delivery date for *Wiz2*.

When *Wiz2* does hit the street, you will be able to set up your own environment. This means you will have total

PERRY COMPUTERS

The Ideal Buy

1-800-248-3823

TANDY COMPUTERS

1000-HX 256K 1-3 1/2" Drive	535.00
1000-TX 640K 1-3 1/2" Drive	860.00
3000-HL 512K 1 5 1/4" Drive	1090.00
3000 640K 1 5 1/4" Drive	1475.00
4000 1 Meg 1 3 1/2" Drive	1890.00
1400LT Portable Computer	1195.00
102 Portable Computer 24K	375.00
Color Computer 3 128K	155.00

MONITORS & BOARDS

VM-4 Monochrome Green	95.00
CM-5 Color RGB	220.00
CM-11 Color RGB	335.00
EGM-1 Color RGB (EGA)	510.00
Tandy Dual Display Card	145.00
Tandy EGA Card	160.00
Zucker Mono Graphics Card	75.00

DRIVES

Color Computer Drive 0	225.00
Portable Drive 100/102/200	155.00
5 1/4" External Drive 1000EX	180.00
3 1/2" External Drive 1000EX	200.00
Tandy 20 Meg Hardcard	509.00
Tandy 40 Meg Hardcard	679.00
Zucker 30 Meg Hardcard	435.00
Seagate 20 Meg Hard Drive	265.00

EXPANSION BOARDS

Zucker Serial Board	45.00
Zucker MFB 384K for 1000SX	130.00
Zucker MFB OK for 1000	103.00
Zucker 1200 Baud Modem Card	72.00

PRINTERS

DMP-106 Dot-Matrix	165.00
DMP-130 Dot-Matrix	255.00
DWP-230 Daisy Wheel	335.00
DWP-520 Daisy Wheel	730.00
DMP-440 Dot-Matrix	595.00
DMP-2120 Dot-Matrix	1325.00
LP-1000 Laser Printer	1635.00
Epson LX-800 Dot-Matrix	195.00
Epson FX-86E Dot-Matrix	355.00
Epson FX-286E Dot-Matrix	520.00
Epson EX-800 Dot-Matrix	425.00
Epson LQ-500 Dot-Matrix	375.00
Epson LQ-850 Dot-Matrix	520.00
Epson LQ-1050 Dot-Matrix	715.00
Epson LQ-2500 Dot-Matrix	905.00
Epson GQ-3500 Laser	1580.00

Price's Subject To Change.
Please Call for Current Prices.
Send For Price List.

All prices and offers may be changed or withdrawn without notice. Advertised prices are cash prices. C.O.D. accepted add 2% (minimum charge \$10.00) M.C. Visa add 2%. All non defective items require return merchandise authorization. Call for RMA Number before returning. Delivery is subject to product availability. Add 1 1/2% for shipping and handling \$5.00 minimum charge.

TM Registered Trademark of Tandy, Epson, and IBM
Monday thru Friday 9am-6pm EST.



PERRY COMPUTERS

124 South Main Street, Perry, MI 48872
CALL 1-517-625-4161 or TOLL-FREE
1-800-248-3823

Protect and highlight your important magazine collection with sturdy RAINBOW binders



Distinctive, Durable RAINBOW Binders

THE RAINBOW is a vital resource to be referred to again and again. Keep your copies of THE RAINBOW safe in our quality, distinctive binders that provide complete protection.

These attractive red vinyl binders showcase your collection and ensure your RAINBOWS are in mint condition for future use. Each binder is richly embossed with the magazine's name in gold on the front and spine. They make a handsome addition to any room.

Put an End to Clutter

Organize your workspace with these tasteful binders. Spend more time with your CoCo and eliminate those frustrating searches for misplaced magazines.

A set of two binders, which holds a full 12 issues of THE RAINBOW, is only \$13.50 (plus \$2.50 shipping and handling).

Special Discounts on Past Issues

To help you complete your collection of THE RAINBOW, we're offering a special discount on past issues of the magazine.

When you place an order for six or more back issues of THE RAINBOW at the same time you order binders, you are entitled to \$1 off the regular back issue price. To order, please see the "Back Issue Information" page in this issue.

Know Where to Look

You may purchase the "Official And Compleat Index To THE RAINBOW" for \$1 when you purchase a set of binders. This comprehensive index of RAINBOW's first three years (July 1981 through July 1984) is usually priced at \$2.50.

For greater convenience, order RAINBOW Binders through the shopping area of the CoCo SIG of Delphi!

_____ YES. Please send me _____ set(s) of RAINBOW binders

Take advantage of these special offers with your binder purchase:

_____ Save \$1 off the single issue cover price for back issues. Minimum order of 6 magazines. Please enclose a back issue order form from a recent issue indicating magazines wanted.

_____ Purchase the "Official and Compleat Index to THE RAINBOW" for \$1. (Regular price \$2.50.)

(These offers good only with the purchase of a RAINBOW binder set)

Name _____

Address _____

City _____ State _____ ZIP _____

My check in the amount of _____ is enclosed. (In order to hold down costs, we do not bill.)

Charge to: VISA MasterCard American Express

Account Number _____ Expiration Date _____

Signature _____

Mail to: Rainbow Binders, The Falsoft Building, P.O. Box 385, Prospect, KY 40059.

Binders are \$13.50 per two-binder set plus \$2.50 shipping and handling. If your order is to be sent via U.S. mail to a post office box or foreign country, please add \$2. Kentucky residents add 5% sales tax. U.S. currency only, please. In order to hold down non-editorial costs, we do not bill.

For credit card orders call (800) 847-0309, 8 a.m. to 5 p.m. EST

All other inquiries call (502) 228-4492.

control over *Wiz2* windows, and will be able to select the screen's type, color and size — within reason and the limits of a 24-line screen.

For example, if you rarely use *Wiz's* interactive graphics mode, you will want to configure your copy of *Wiz2* to run in text-only screens. Windows will open up to three times faster, and text will scroll by on the screen much more quickly. Additionally, you'll be able to use more colors in a screen than you can when you run in a slower graphics screen.

Data Master Does Windows

We finally got a chance to fire up *Data Master*, the new OS-9 database manager from Paul and Sue Searby at Computerware, 4403 Manchester Ave., Suite 102, Box 668, Encinitas, CA 92024. This program can read old files you created under *Databank Manager* or *OS-9 Profile*. It can also read files created by *DynaCalc* — or write out its own information in a form that can be read by *DynaCalc*.

To run *Data Master*, you create an 80-by-24, Type 2 window and start an OS-9 shell in it. At that point, you need only type DM to run this program —

assuming, of course, that you have stored a copy of the file DM in your current execution directory. Once *Data Master* is running you really don't need a manual. Basically, the only thing you need to know is that you can see the items in the first menu by pressing the slash key (/). When you've done this, a menu window pops down under the Desk menu.

Like all professional OS-9 programs, *Data Master* gives you direct access to the OS-9 shell from within the program. And like any good database program, it validates your data for you while you are typing it. Other important *Data Master* features include its ability to restructure a data file and the ability to compress your files by permanently removing all deleted records (useful when you need to save disk space).

More on Packet Radio

During the past month, we spoke with John Lind, KD7XG, Orange Section Technical Coordinator of the American Radio Relay League, and received both bad and good news. The bad news is that John has discontinued his project to port the WA7MBL packet bulletin board program to OS-9. As he

owns a CoCo 2, which limits him to 64K of memory, he decided after a few starts that it just wouldn't fit. He didn't believe he could get the capability out of the program with such limited memory.

The good news is that he has written an impressive high frequency propagation program in OS-9 PASCAL. He reports that it screams when compared to a C program he had written earlier. He promises to send in several procedures that demonstrate how to exercise the OS-9 windowing and graphics environment from within PASCAL. We'll share them with you when they arrive.

Lind is also writing a satellite orbit prediction program in OS-9 PASCAL. Run from his CoCo, the program will drive an automatic antenna controller, which is itself a Z-80 microprocessor with 8K of RAM. His ultimate goal is to provide an automatic satellite link for his packet radio bulletin board. He has some interesting challenges ahead, because he must come up with a way to compensate for the Doppler shift on the radio uplink to the satellite.

On the Color Computer Packet Radio Bulletin front, I learned this week that WJ5W has written a BBS for RS-DOS. Better yet, Robert Billson, KC-

OS-9 SOFTWARE from D. P. JOHNSON

L1 UTILITY PAK - Contains 40 useful utilities that run under both level I and II OS-9. Included are a complete set of "wild card" file handling utilities, a disassembler, a disk sector editor, and the MacGen command language compiler. MacGen will allow you to generate many useful command macros in minutes, much more useful than procedure files. Macro source is included for a macro to implement an archival backup type function. **\$49.95**

L2 UTILITY PAK - Contains a Level II "printerr" function that also shows the pathname being searched for when "not found" or permission type errors occur. Also contains level II software ram disk driver. Ten other utilities included, some useful for level I also. **\$39.95**

L1+L2 COMBINATION PAK both of above together for **\$75.00**

SDISK - Standard disk driver module replacement allows full use of 40 or 80 track double sided drives with OS-9 Level I. Full compatibility with CoCo 35 track format and access all other OS-9 non-CoCo formats. Easy installation. **\$29.95**

SDISK+BOOTFIX - As above plus boot directly from a double sided diskette. **\$35.95**

SDISK3 - Level II version of SDISK driver. Same features as level I (except bootfix not required to boot from double sided). **\$29.95**

PC-XFER UTILITIES - Programs to format and transfer files to/from MS-DOStm diskettes on CoCo under OS-9. (Requires either SDISK or SDISK3 to run depending on which level of OS-9 you are using) **\$45.00**

MSF - MS-DOS disk format file manager. More complete file transfer capabilities for level II only. (Requires SDISK3 to operate). **\$45.00**

CCRD 512K byte RAM DISK CARTRIDGE - Operates faster than similar device sold by others. Requires RS Multipak interface, two units may be used together for 1MB. OS-9 Level I & II drivers and test software included. **\$169.00**

All diskettes are in CoCo OS-9 format; other OS-9 formats can be supplied for \$2.00 additional charge. All orders must be prepaid or COD, VISA/MC accepted, add \$1.50 S&H for software, \$5.00 for CCRD, additional charge for COD.

D. P. Johnson, 7655 S.W. Cedarcrest St., Portland, OR 97223

(503) 244-8152 (For best service call between 9-11 AM Pacific Time, Mon.-Fri.)

OS-9 is a trademark of Microware and Motorola Inc., MS-DOS is a trademark of Microsoft, Inc.

DISKMASTER HARD DISK SYSTEM

The DISKMASTER system has features no other system has:

- 20 MB SCSI hard disk
- High Density floppy drive with over 1 MB storage per disk (The ONLY HD floppy system available for the COCO, at least twice the speed of normal floppies.)
- Battery backed up Clock/Calendar
- 3 Serial ports
- Bi-directional parallel (printer) port
- Expansion port for additional Floppy drives
- Single cable interface to COCO 3
- All interface software for OS-9 level II included **\$1295.00**
- Optional RAMDISK up to 1.5 MB (Call for price)

A dual HD floppy model is available with all the features listed above except the hard disk is replaced by a second floppy. **\$795.00**

You can get a cheaper system elsewhere but not with all the features and performance of the DISKMASTER.

PLUS-100 512K MEMORY EXPANSION

\$109.00 (+\$2.50 S&H)

The most reliable 512K memory expansion board for the COCO 3. Our products are designed to be the most reliable, not the cheapest.

Send for a COLOR BROCHURE fully describing the DISKMASTER and PLUS-100 Memory Expansion.

Visa and Mastercard accepted, call for Diskmaster shipping charges.

HEMPHILL ELECTRONICS INC.

**334 Paseo Tesoro
Walnut, CA 91789**

(714) 598-7799 (Phone hrs. 10 AM-2 PM Mon.-Thurs. Pacific Time)

You may also contact D. P. Johnson (see left) to answer your technical questions about the DISKMASTER system.

About The One-Liner Contest . . .

THE RAINBOW's One-Liner Contest has now been expanded to include programs of either one or two lines. This means a new dimension and new opportunity for those who have "really neat" programs that simply just won't fit in one line.

Here are the guidelines: The program must work in Extended BASIC, have only one or two line numbers and be entirely self-contained — no loading other programs, no calling ROM routines, no poked-in machine language code. The program has to run when typed in directly (since that's how our readers will use it). Make sure your line, or lines, aren't packed so tightly that the program won't list completely. Finally, any instructions needed should be *very* short.

Send your entry (preferably on cassette or disk) to:

THE RAINBOW
One-Liner Contest
P.O. Box 385
Prospect, KY 40059

2WZ, is porting that program to OS-9.

Recently I copied a message from an amateur packet radio operator in Pennsylvania asking for some information about the RS-232 pack and OS-9 terminal programs. I sent him a message, and the next day I had a thank-you message back and a request for more information. Earlier in the week I sent an anniversary message to my parents in Kansas via packet radio. They received a call from a local ham with the message less than 18 hours after I sent it. Hams are using ZIP code forwarding in their packet bulletin board programs to accomplish this magic. There is already a Color Computer version of the *WORLI* bulletin board available on CompuServe's HamNet. I hope to come up with something for OS-9 soon.

Packet radio communications isn't the only radio mode that can use the services of your Color Computer and OS-9. Jerry Murphy, a ham operator in the Cleveland area, uses *Wiz* to download weather maps from WLO in Atlanta and from CFN in Halifax. He lets *Wiz* capture the maps and write them to disk overnight. In the morning, he prints up the maps and passes them to ships at sea on the 20-meter maritime mobile net. Murphy was the net manager of the Hurricane Net for 25 years before retiring from the job last year.

Shell3 and a Few Tips

Last month we introduced you to *Shell+*. We've used it for almost two months now and don't know how we got along without it. Now, however, there's more — *Shell3* has arrived. You'll find it in a data library on your favorite online SIG.

Kevin Darling and his partners have added `pxd` and `pwd` to the list of features built into *Shell*. They have also made it

possible for you to take the name of your current data directory and make it part of your prompt. You do this by typing `$` when you change prompts. `#` prints the process number, `@` prints the current device name, and `$` will show the name of your working data directory.

Another important *Shell3* enhancement is the fact that the program will accept a command line in which you have already typed the parentheses and quotes. This caused a problem with *Shell+* when you ran programs like *Sculptor* that insert these delimiters for you.

During the two months we have used *Shell+*, we have grown quite fond of the append and overwrite features. For example, you can append a favorite listing to an existing file by typing `list favorite >+ FileWithItAll`. Or, if you want to merge a new module into your *Shell* file, you can do so by typing `merge NewModules >+ NewShell-File`. It's a great shortcut!

Here's another! We recently heard about a guy who has set up *Multi-View* with icons for all the great CoCo 3 game programs. His 6- and 10-year-old sons now boot up *Multi-View* and run their own games — when they want them. No adult supervision required.

Cray Augsburg forwarded a letter to us recently from Ronald W. Wilson, who was looking for a quick lesson in printing from BASIC09. You'll find the secret in the short procedure shown in Figure 1, Ron.

More Tips

One of the problems you run into when you start working with large BASIC09 programs like *KISSDraw* is a shortage of memory in your 64K process area. The problem is also especially

```
procedure DemoPrint
DIM printer:INTEGER
OPEN #printer, "/p": WRITE
(* You now have a path open to the printer
(* and can use it at will. For example:
PRINT #printer, "Now testing a DMP-105 printer!"
CLOSE #printer
END
```

Figure 1

TEXTPRO-IV

"The ULTIMATE Color Computer III Word Processing System"

9 Hi-Res Displays from 58 to 212 columns by 24 lines in 225 Res.
Screen Display of Bold, Italic, Underline & Double Width print.
9 Proportional Character Sets Supported with full Justification.
80 Programmable Function Keys & Loadable Function key sets.
Three Programmable Headers and One Programmable Footer.
Automatic Footnote System places lines at the bottom of a page.
7 Tab Commands, with: Center, Left, Right and Decimal align.
Autoexecute Startup files for easy printer & system setup.
8 Pre-Defined & 10 Programmable printer function commands.
Supports Library files for unlimited printing & configurations.
Disk file record access for Mail Merge & Boiler Plate printing.
Complete Automatic Justification, Centering, Flush left & right.
Change indents, margins, line length, etc. anytime in the text.
Create and Edit files larger than memory, up to a full disk.
Easily imbed any number of printer format and control codes.
Compatible with all printers including Laser printers.
Built in Ultra Fast 2 drive RAMDISK for 512K support.

TEXTPRO IV is the most Powerful Word Processing System available for the COCO-3, designed for speed, flexibility and extensive document processing. It is like most of the other word processing programs available for the Color Computer. If you are looking for a simple word processor to write letters or other short documents, and never expect to use multiple fonts or proportional printing, then most likely you'll be better off with one of the other simple word processors. But, if you want a powerful word processor with extensive document formatting features to handle large documents, term papers, manuals, complex formatting problems and letter writing, then TEXTPRO IV is the answer. It works in a totally different way than most word processing programs. It uses simple 2 character abbreviations of words or phrases for commands and formatting information that you imbed directly in your text. There are over 70 different formatting commands you can use without ever leaving the text your working on. There are no time consuming and frustrating menu chases, you are in total control at all times. You can display the formatted document on the screen before a single word is ever printed on your printer. Including margins, headers, footers, page numbers, page breaks, column formatting, justification, and Bold, Italic, Underline, Double Width, Superscript and Subscript characters.

TEXTPRO IV can even support LASER PRINTERS with proportional fonts. Take a good look at this AD? It was done with TEXTPRO IV on an OKIDATA LASERLINE-6 laser printer!!! All of the character sets used on this AD are proportional, all centering, justification, font selection, and text printing was performed automatically by TEXTPRO IV.

What you see is what you get!

TEXTPRO IV has 9 Hi-Resolution screen fonts to choose from, with 58 to 212 characters per line in 225 Resolution, for the best display possible. You can easily match the width of your printed page to the screen and you can have it automatically change display widths as you change printer fonts so you can even display the "fine print". All of the screen fonts can display, Bold, Italic, Underline, Superscript, Subscript and Double Width characters. When you want to see what your printed document will look like, TEXTPRO IV will let you see it on the screen in all its glory, so that, "What you see is what you get".

Standard Commands

TEXTPRO IV has all the document formatting commands you expect in a word processor and then some. The setup commands include: line length, top margin, bottom margin, page length, page numbering on/off, page format on/off, automatic word fill on/off and justification left, center, right or full. Some of the vertical control features include: Test for a number of lines left on a page, skip to next page, set page number, page pause, single and multiple line spacing.

TEXTPRO IV features 3 programmable Header lines that can be centered, left or right justified and one programmable Footer line. There are 3 commands for continuous, single and paragraph indenting, Center Text, Center Line and Right Justify text with character fill.

Printer & Special Commands

TEXTPRO IV has 8 pre-defined printer & screen commands for Bold, Italic, Double Width, Underline, Subscript, Superscript, Condensed and Double Strike print. It also has 10 programmable functions that you can use to access intelligent printer features like: Graphics, variable line spacing, half line feed, horizontal & vertical positioning. There are also 3 other printer commands that allow you to imbed control code sequences anywhere in the text.

There is a Footnote command that will automatically place footnotes at the bottom of the page. Another command allows you to display a message on the screen and input text from the keyboard, to be included in your printed document. There is also a repeat command that allows you to repeat an entire document or part of one, up to 255 times.

Tab Functions

TEXTPRO IV features an elaborate system of tab commands for complete control over column formatting. There are 10 programmable tab stops that can be defined and re-defined at any time. They can be used to: Center over Tab column, Right Justify to Tab column, Decimal Align over Tab column, Left Justify to Tab column (Normal Tab) and Horizontal Tab. They can also be used with a numeric column position for maximum flexibility.

Proportional Fonts & Printing

TEXTPRO IV is the only Color Computer III Word Processing system that gives you Justified Proportion Printing, which can give your documents and letters that professional touch that just isn't obtainable with fixed or mono spaced printing. And just about all printers today support proportional fonts, and with Laser Printers you can get typesetting quality output for just pennies a page. TEXTPRO IV supports up to 9 proportional fonts, with full justification. And, you can even mix mono spaced and proportional fonts for maximum flexibility. Even if you don't use proportional printing, you can select between Pica, Elite and Condensed fixed width fonts to get fully justified printing.

Mail Merge and Text Processing Disk Functions

TEXTPRO IV supports several commands that allow you to import data or text from other disk files. They allow you to include information like names and addresses for Mail Merge capability, Import standard paragraphs or other information for Boiler Plate type functions and more. Some of the commands include: Open a file, Field a Record, Read a Record into fielded variables, Read single or multiple lines and Trim spaces from the trailing end of fielded variables.

Another powerful disk function not to be overlooked is the "LIBRARY" command that allows you to include the entire contents of a file in your text. This can be very useful for a great many applications. You can use a Library command to automatically include a standard or optional printer setup command file, or to include standard paragraphs, headers or information created from a spread sheet or any other program. And, for printing very large documents that consist of several files linked together.

Autoexec Startup Files

TEXTPRO IV will automatically load and execute a command text file when it first executes. This allows you to customize the program configuration for your system and printer whenever you startup TEXTPRO IV. You can setup the screen display format, colors, adjust automatic key repeat, printer baud rate, load a set of function keys, load your printers control codes and more.

80 Programmable Function Keys

TEXTPRO IV allows you to have up to 80 function keys with just about any kind of information or command sequences you can imagine. Once programmed, you can have a command sequence execute using a single function key. You can also Save and Load function key sets at any time. So, you can have several sets for different writing tasks or projects, the possibilities are endless. Just think, with a single function key you could, load a disk file, search for and replace all the occurrences of a phrase, save the file back to disk, have it processed and printed!

Text Editing

TEXTPRO IV has a powerful, full featured, line oriented screen editor that is faster and more efficient than most editors you've ever worked with. It supports single or multiple line copy and move, global or local search and replace, word and character insert/delete, block delete and much more. It features adjustable automatic key repeat, selectable display foreground and background colors, screen line width and more.

TEXTPRO IV uses fully compatible ASCII formatted files. You can even direct formatted output files to a standard ASCII disk file. It will Load, Save, Append, Kill, Text Process files from disk, Roll part of a file to disk, Get next portion of a file, display a Directory and Backup Ramdisk to & from Floppy disks.

TEXTPRO IV's files are also compatible with spelling checker programs like Spell 'n Fix from Star Kits, a shareware program, available with TEXTPRO IV for your evaluation, just for the asking.

Fully Buffered Keyboard

While many word processing programs are slow and often lose keystrokes, TEXTPRO IV has a fully buffered keyboard that is virtually impossible to out type. Even when it's busy, it will still remember the keystrokes entered. You can enter in commands or whatever, even during insert mode you'll never lose a key.

Professional Word Processing Power

TEXTPRO IV is a powerful tool for both the Casual and Professional Word Processing user. It offers a wide range of features and functions that can satisfy even the most demanding writer. Even though you may not need all of TEXTPRO IV's power and flexibility right now, its not a program that you can easily outgrow. As your needs and skills improve, you'll discover that you won't need to go out and buy another word processing program, TEXTPRO IV will already be ready and waiting. No Text Processing program available for the Color Computer III gives you more Text Processing Power than TEXTPRO IV. It can make your writing appear more professional than you ever thought possible. Check around, see what other word processing programs have to offer in terms of power, speed and flexibility. When your finished comparing them against TEXTPRO IV, you'll see that it's the only real choice for the Color Computer III.

Requires 128K & Disk \$89.95

To order TEXTPRO IV by mail, send check or money order for the amount of purchase, plus \$3.00 for shipping & handling to the address below.
To Order by VISA, MASTERCARD or COD call us at (702) 452-0632
(Monday thru Saturday, 8am to 5pm PST)

CER-COMP LTD.

5566 Ricochet Avenue
Las Vegas, Nevada 89110
(702) 452-0632

Coming Soon: CoCo 1 & 2 versions of TEXTPRO IV

Submitting Material To Rainbow

Contributions to THE RAINBOW are welcome from everyone. We like to run a variety of programs that are useful/helpful/fun for other CoCo owners.

WHAT TO WRITE: We are interested in what you may wish to tell our readers. We accept for consideration anything that is well-written and has a practical application for the Tandy Color Computer. If it interests you, it will probably interest lots of others. However, we vastly prefer articles with accompanying programs which can be entered and run. The more unique the idea, the more the appeal. We have a continuing need for short articles with short listings. These are especially appealing to our many beginners.

FORMAT: Program submissions must be on tape or disk, and it is best to make several saves, at least one of them in ASCII format. We're sorry, but we do not have time to key in programs and debug our typing errors. All programs should be supported by some editorial commentary explaining how the program works. We also prefer that editorial copy be included on the tape or disk using any of the word processors currently available for the Color Computer. Also, please include a double-spaced printout of your editorial material and program listing. Do not send text in all capital letters; use upper- and lowercase.

COMPENSATION: We do pay for submissions, based on a number of criteria. Those wishing remuneration should *so state* when making submissions.

For the benefit of those who wish more detailed information on making submissions, please send a self-addressed, stamped envelope (SASE) to: Submission Guidelines, THE RAINBOW, The Falsoft Building, P.O. Box 385, Prospect, KY 40059. We will send you comprehensive guidelines.

Please do not submit material currently submitted to another publication.

acute with BBS programs and others that call in a number of subroutines.

In a recent conversation, Kevin Darling and I wondered why neither of us had thought of the technique that can eliminate most of your problems. It had been right there in the manual all the time — it's a good thing it wasn't a snake. Even though the subroutines like to stick around, there is a way to get rid of them. Use the command `kill` to unlink a procedure from your RunB space — or your BASIC09 space. Here's some sample code:

```
RUN GFX2("clear")
KILL "GFX2"
```

or

```
sub$="gfx2"
RUN sub$
KILL sub$
```

Another question that keeps popping up concerns the C compiler and the fact that the authors hard-coded it to look for the library files on a drive named `/D1`. To solve the problem, patch `CC1`

and `C.PREP` with `Modpatch`, shown in Figure 2.

Also on the C front, Greg Law points out that you must use the new assembler and linker supplied with the Development System when you use the new libraries that come with *Multi-Vue*. The new libraries are stored in a slightly different format that the old linker doesn't recognize. To use the new assembler and linker, delete `c.asm` and `c.link` from your compiler disk, rename `rma` to `c.asm`, and rename `rlink` to `c.link`. Then you can use either the old or new library formats without any trouble.

And while we're handing out tips, Mike Washburn has contributed this one for *Home Publisher* users trying to use a Gemini 10X with the Epson driver. Mike reports he had luck with the following patch. The `Hi-Res` command, `Esc Z`, should be changed to `Esc z`. The procedure script is shown in Figure 3. After you start *Home Publisher*, set baud rate, no line feeds, and select the Gemini Driver. Thanks, Mike.

```
* MODULE:    ccl

* PROBLEM:   Hard coded for /D1

* SPECIFIC:  Change the /D1 string to /DD

*

modpatch

L CC1

C 0EE6 31 44

V

* MODULE:    c.prep

* PROBLEM:   Hard coded for /D0

* SPECIFIC:  Change the /D0 string to read /DD instead

*

modpatch

L C.Prep

C 135D 31 44

V
```

Figure 2: Modpatch

```

BUILD epson.p

L prn.EpsRX80

C 0049 5A 7A * Z -> z

V

<ENTER>

LOAD /Dx/CMDS/prn.EpsonRX

MODPATCH epson.p

SAVE /Dx/CMDS/prn.Gemini prn.EpsRX80

ATTR /Dx/CMDS/prn.Gemini pe e

PUBLISH [opts]

```

Figure 3

Listing 1: DefsDemo

```

PROCEDURE DefsDemo
0000 (* First lets define a data type we can use to create a device window
0045
0046 TYPE DW=action:INTEGER; sty,cpx,cpy,szx,szy,fprn,bprn,bdprn

:BYTE

0073
0074 (* Now we need to reserve room in memory for our data
00A9
00AA DIM path:BYTE
00B1 DIM MakeDW:DW
00BA
00BB (* The next statement opens a path to a window.
00EA (* You must make sure that window does not already exist.
0123 (* you can do this by typing "deiniz W12" at the Basic09 prompt.
0163
0164 OPEN #path,"/W12":WRITE
0173
0174 (* Now we must initialize the data in our new structure.
01AC
01AD MakeDW.action:=$1B20
01B9 MakeDW.sty=2
01C4 MakeDW.cpx=0
01CF MakeDW.cpy=0
01DA MakeDW.szx=20
01E5 MakeDW.szy=12
01F0 MakeDW.fprn=0
01FB MakeDW.bprn=2
0206 MakeDW.bdprn=1
0211
0212 (* Once we have initialized the data we can put the structure
024F (* out on the path we created earlier.
0275
0276 PUT #path,MakeDW
0280
0281 (* In order to see the new window, we must "select" it.
02B8
02B8
02B9 RUN gfx2(path,"select")
02CC PRINT #path,"Hello OS-9 Level II Fans"
02ED FOR x:=1 TO 10000 \NEXT x
030B
030C (* After we have displayed our new window for a few seconds we must
034F (* tell Basic09 that we want to return to our original window or the
0393 (* program will lock in the new window. There is no way for it to
03D5 (* get any information from the keyboard while the new window is.
0416 (* selected.
0422
0423 RUN gfx2(1,"select")
0434 END

```

A Short Listing

We have included a short listing this month to get you thinking again about data structures in BASIC09 (see Listing 1). We define a new data type for a device window and then show you how you can put it out to a path when you want to open a new window. It's a warm-up for a closer look at *Multi-View* and at some of the techniques you will need to write applications using the window manager, `WindInt`. Hopefully, we'll be able to translate several of the C data structures introduced in the *Multi-View* manual into BASIC09 data types and show you how you can use them to your advantage.

"A ballot printed on Page 11 of MOTD gives you a chance to vote for a new slate of officers."

Another Handy Goldberg Utility

Steve Goldberg, 695 Plainview Road, Bethpage, NY, who sells the fantastic OS-9 utility package *Utilipak Plus* at approximately \$2 per utility, is back again this month with a program called `Cmdgen`. It generates OS-9 modules that execute existing programs — or a series of programs — from a short command line. For example:

```

OS9: cmdgen write ENTER
> chd /d1/letters ; edit *
; list * >/p ENTER

```

The keystrokes above will generate a module called `write`. When you want to write and print a letter, you need only type `write`, followed by the filename you want to use to store the letter. Goldberg suggests that you should use full pathlists when you generate `Cmdgen` modules, as they may be executed from any directory on your computer. If you forget the commands you put in a `Cmdgen` module, you can generate a reminder by typing `os9: cmdgen filename ENTER`.

Enjoy `Cmdgen`, and we'll join you in June for more OS-9 tips and tricks. □

T & D SUBSCRIPTION SOFTWARE CONTINUES ITS

ISSUE #1, JULY 1982

COVER 1
RACETRACK
HANGMAN
MUSIC ALBUM
LIFE EXPECTANCY
WORD TESTS
KILLER MANSION
BARTENDER
CALENDAR
ROBOT WAR

ISSUE #2, AUGUST 1982

UFO COVER PT. 1
BIORHYTHM
BOMBARDMENT
BLACK JACK
COST OF LIVING
FRENZY
BUSINESS LETTER
QUICK THINK
QUEST INSTRUCTIONS
QUEST FOR LENORE

ISSUE #3, SEPTEMBER 1982

UFO COVER PT. 2
BASKETBALL
CHUCKLUCK
SLOT MACHINE
ALPHABETIZER
NFL PREDICTIONS
FLAG CAPTURE
ROBOT BOMBER

ISSUE #4, OCTOBER 1982

UFO RESCUE
TANK BATTLE
DRIVEWAY
SOUNDS
BALLOON DROP
MIND BOGGLE
COCO-TERRESTRIAL ADV.
CALORIE COUNTER
JACK-O-LANTERN

ISSUE #5, NOVEMBER 1982

CATALOG COVER
BOWLING
PROGRAM INVENTORY
PROMISSORY-LOANS
CHECKBOOK BALANCER
TRIGONOMETRY TUTOR
CONVOY
BAG-IT
SPECTRA SOUND
CONVEYOR BELT

ISSUE #6, DECEMBER 1982

CHRISTMAS COVER
RAINDROPS
STOCK MARKET
ADVANCED PONG
DESTROY
SOUND ANALYZER
CREATIVITY TEST
VOICE DATA
ML TUTORIAL PT. 1
LOONY LANDER

ISSUE #7, JANUARY 1983

NEW YEARS COVER
LIST ENHANCER
SUPER PRECISION DIV.
BOMB DIFFUSE
SPACE STATION
ML TUTORIAL PT. 2
SHOOT OUT
FIND UTILITY
CYRORG INS.
CYBORG FACES

ISSUE #8, FEBRUARY 1983

COVER 8
DEFEND
3 DIMENSIONAL MAZE
COCO CONCENTRATION
AUTO LINE NUMBERING
ML TUTORIAL PT. 3A
ML TUTORIAL PT. 3B
NUCLEAR POWER PLANT
DUAL BARRIER
BRICKS

ISSUE #9, MARCH 1983

TIME MACHINE COVER
TRIG DEMO
PYRAMID OF CHEOPS
PROGRAM PACKER
BUDGET
ELECTRONIC DATEBOOK
ML TUTORIAL PT. 4
TAPE DIRECTORY
BLOCK-STIR
COCO ADDING MACHINE

ISSUE #10, APRIL 1983

TENTH COVER
PYRAMID OF DANGER
TYPING TUTOR
ML TUTORIAL PT. 5
TINYCALC
STOCK MARKET COMP
YAH-HOO
MISSILE ATTACK
SCREEN PRINT
BRIK-PONG

ISSUE #11, MAY 1983

ELEVENTH COVER
ARCHERY
FROG JUMP
ML TUTORIAL PT. 6
MLT DICTIONARY
BASIC SPEED UP TOT.
METRIC CONVERTOR
GRAPHIC QUAD ANTENNA
GRAPHICS PROGRAM
CATERPILLAR CAVE

ISSUE #12, JUNE 1983

TWELFTH COVER
SHOOTING GALLERY
BOMB STOPPER
VALLEY BOMBER
STARFIGHTER
WHEEL OF FORTUNE
ML TUTORIAL PT. 7
MERGE UTILITY
RAM TEST
LANDER

ISSUE #13, JULY 1983

THIRTEENTH COVER
FLASH CARD
ICE BLOCK
COSMIC FORTRESS
MAIL LIST
DOLLARS & CENTS
ML TUTORIAL PT. 8
SDSK COPY
MUSIC SYNTHESIZER
CRAWLER

ISSUE #14, AUGUST 1983

MYSTERY COVER
ROW BOAT
COMPUTER TUTL PT. 1
INDEX DATABASE
DISK ZAPPER
COCO-MONITOR
COCO-ARTIST
ROBOT COMMAND
TEST SCREEN PRINT
HIGH RESOLUTION TEXT

ISSUE #15, SEPTEMBER 1983

MYSTERY COVER PT. 2
GOLD VALUES
TREK INSTRUCTIONS
TREK
HIGH TEXT MODIFICATION
ASTRO DODGE
DR. COCO
PEG JUMP
MORSE CODE
PURGE UTILITY

ISSUE #16, OCTOBER 1983

MYSTERY COVER
BOPOTRON
DIRECTORY RECALL
VECTOR GRAPHICS INST.
VECTOR GRAPHICS
SKYDIVER
SWERVE AND DODGE
NIMBO BATTLE
TAPE ANALYSIS UTILITY
LIFE GENERATIONS

ISSUE #17, NOVEMBER 1983

THANKSGIVING COVER
3-D TIC-TAC-TOE
INDY 500
COLLEGE ADVENTURE
MEMORY GAME
DUNGEON MASTER
WEATHER FORECASTER
GRID FACTOR INST.
GRID FACTOR
DRAW

ISSUE #18, DECEMBER 1983

CHRISTMAS COVER
CLIMBER
GALACTIC CONQUEST
WARLORDS
STATES REVIEW
MATH TUTOR
MACHINE LANGUAGE DATA
PRINTER UTILITY INST.
PRINTER UTILITY
MUTANT WAFFLES

ISSUE #19, JANUARY 1984

BANNER
PROBE
DISK DIRECTORY PROTECTOR
OPTICAL CONFUSION
WORD PROCESSOR
WORD SEARCH
ASTRONAUT RESCUE
STAR TRAP
PIE CHART
FORCE FIELD

ISSUE #20, FEBRUARY 1984

INTRODUCTION:
HINTS FOR YOUR COCO
ESCAPE ADVENTURE
SEEKERS
MASTER BRAIN
LIST CONTROLLER
DISKETTE CERTIFIER
ROM COPY
BASIC RAM
SNAFUS

ISSUE #21, MARCH 1984

BASIC CONVERSIONS
FINANCIAL ADVISE
CASTLE STORM
DOS HEAD CLEANER
COCO TERMINAL
SNAKE CRAWLER
WAR CASTLE
SKY FIRE
EASY BASIC
DOTS 3-D

ISSUE #22, APRIL 1984

HEALTH HINTS
GLIBLIBS
CLOTHIER SLITHER
BIBLE 1 & 2
BIBLE 3 & 4
CATCH ALL
INVADER
ALIEN RAID
MOON ROVER
10 ERROR IGNORER

ISSUE #23, MAY 1984

MONEY SAVERS 1 & 2
STOCKS OR BOMBS
WALL AROUND
COCO TECHNICAL LOOK PT. 1
NUCLEAR WAR INST.
THERMONUCLEAR WAR
CIRCUIT DRAWER
MOUSE RACES
SUPER-SQUEEZE
DATA FALL

ISSUE #24, JUNE 1984

DIR PACK & SORT
BRICK OUT
COCO TECHNICAL LOOK PT. 2
USA SLIDE PUZZLE
51' 24" SCREEN EDITOR
51' 24" SCREEN
CITY INVADERS
PRINTER SPOOLER
STEPS
SNAKE

ISSUE #25, JULY 1984

CLOCK
COCO TECHNICAL LOOK PT. 3
SKID ROW ADVENTURE
MONEY MAKER
PIN-HEAD CLEANING
LINE EDITOR INST.
LINE EDITOR
BOOMERANG
BUBBLE BUSTER
RECOCHET

ISSUE #26, AUGUST 1984

PEEK, POLE & EXECUTE
SAUCER RESCUE
YOUNG TYPER TUTOR
O-TEL-O
OLYMPIC EVENTS
DOUBLE DICE
COCO DATABASE
BATTLE STAR
COCO-PIN BALL
MONTEZUMAS DUNGEONS

ISSUE #27, SEPTEMBER 1984

COCO TO COM 64
GALACTIC SMUGGLER
INDY RACE
ACCOUNT MANAGER
CASSETTE MERGE UTILITY
STRING PACKING TUTORIAL
SPACE DUEL
BUGS
TRAP-BALL
BALLOON FIRE

ISSUE #28, OCTOBER 1984

HANGING TREE
CHECKERS
FOOTBALL +
MORE PEEKS, POKES
SPELLING CHECKER
SOUND DEVELOPMENT
WORD GAME
SCREEN REVERSE
AUTO COPY
RAT ATTACK

ISSUE #29, NOVEMBER 1984

DISK ROLL OUT
ROBOT ON
MULTIPONG
ADVENTURE GENERATOR
QUEST ADVENTURE
QUARTER BOUNCE
DUAL OUTPUT
KEY REPEAT
FULL EDITOR
METEOR

ISSUE #30, DECEMBER 1984

MATH HELP
ZECTOR ADVENTURE
WORLD CONQUEST
DRAG RACE
MINE FIELD
T-NOTES TUTORIAL
T & D PROGRAM INDEXER
SYSTEM STATUS
ERROR TRAP
DROLL ATTACK

ISSUE #31, JANUARY 1985

TREASURES OF BARROOM
BATTLE GROUND
STRUCTURED COMPILED LANGUAGE
LIBRARY MODULE
MINIATURE GOLF
STAR DUEL
ARITHMETIC FOOTBALL
GRID RUN
SPIRAL ATTACK
FAST SORT
MUNCHMAN

ISSUE #32, FEBRUARY 1985

DR. SIGMUND
ICE WORLD ADVENTURE
LOTTERY ANALYST
BASIC COMPILER
MUSIC CREATOR
MEANIE PATROL
TRI-COLOR CARDS
SHAPE RECOGNITION
DISK BACKUP
SPACE PROTECTOR

ISSUE #33, MARCH 1985

LIGHT CYCLE
PAINT
SKEET SHOOTING
GUITAR NOTES
ML DISK ANALYZER
PERSONAL DIRECTORY
NAUGHA ADVENTURE
EGGS GAME
DISK DIRECTORY PRINT
SPEED KEY

ISSUE #34, APRIL 1985

HOVER TANK
POWER SWORD
TERMITE INVASION
SPELLING CHECKER
DOS BOSS
NINE CARD CHOICE
MUSIC GENERATOR
FYR-DRACA
DRIVE TEST
GRAPHIC TOUR

ISSUE #35, MAY 1985

SELECT A GAME 1
TAPE PROBLEMS
STROLL TRIVIA
SOFTBALL MANAGER
FONTS DEMO
CLOWN DUNK MATH
ALPHA MISSION
DOS ENHANCER
HAUNTED HOUSE



SUPER SAVINGS

Single Issue \$8.00
2-5 Issues \$6.00 ea.
6-10 Issues \$5.00 ea.
11 or more Issues . \$4.50 ea.
All 67 Issues \$185.00

Purchase 20 or more issues and receive a free 6 month subscription

- Every Issue Contains 10 or More Programs
- Many Machine Language Programs
- Available for COCO I, II and III
- All Programs Include Documentation

- We send 1st Class No Charge
- Personal Checks Welcome!



BACK ISSUE SALE OF OVER 670 PROGRAMS!

- ISSUE #36, JUNE 1985**
SELECT A GAME 2
VIDEO COMPUTERIZER
SPEECH SYNTHESIS
SPEECH RECOGNITION
SPACE LAB
AUTO COMMAND
COMPUTER MATCHMAKER
KNIGHT AND THE LABYRINTH
STAR SIEGE
TALKING SPELLING QUIZ
- ISSUE #37, JULY 1985**
CHESS MASTER
BIBLE 5-7
SHIP WREK ADVENTURE
FILE TRANSFER
FOUR IN A ROW
MARSHY
TAPE CONTROLLER
CATACOMB
AUTO TALK
SGR8PAK
- ISSUE #38, AUGUST 1985**
GOLF PAR 3
WIZARD ADVENTURE
KITE DESIGN
ROBOTS
GOMOKU
AMULET OF POWER
LINE COPY UTILITY
DISK PLUMBER
SUPER RAM CHECKER
GRAPHIC HORSE RACE
- ISSUE #39, SEPTEMBER 1985**
DRUNK DRIVING
CAR MANAGER
SQUEEZE PLAY
SUPER BACKUP
RECIPE MACHINE
ANTI-AIRCRAFT
UNREASON ADVENTURE
TALKING ALPHABET
SUPER VADERS
AUTOMATIC EDITOR
- ISSUE #40, OCTOBER 1985**
STAR TREK
HAM RADIO LOG
COCO-WAR
DISK LABELER
SHIP WAR
ELECTRIC COST
MULTIKEY BUFFER
NUKE AVENGER
CURSOR KING
SAND ROVER
- ISSUE #41, NOVEMBER 1985**
GRUMPS
DISK DRIVE SPEED TEST
SOLAR CONQUEST
GAS COST
RIME WORLD MISSION
WUMPUS
CHARACTER EDITOR
GRAPHIC TEST
GRAPHIC LOOPY
BOLD PRINT
- ISSUE #42, DECEMBER 1985**
HOME PRODUCT EVALUATION
YAHTZEE
DISK UTILITY
MACH II
ELECTRONIC BILLBOARD
CAR CHASE
SUPER MANSION ADVENTURE
SLOT MACHINE GIVE AWAY
TEXT BUFFER
TUNNEL RUN
- ISSUE #43, JANUARY 1986**
DUELING CANNONS
WATER COST
ZIGMA EXPERIMENT
MUSICAL CHORDS
SAFE PASSAGE
PASSWORD SCRAMBLER
GUNFIGHT
KEYPAD ENTRY
STYX GAME
PRINTER DIVERT
- ISSUE #44, FEBRUARY 1986**
HOME INVENTORY
NINE BALL
PRINTER REVIEW
EXPLORER ADVENTURE
SPANISH LESSONS
CROSS FIRE
RAM SAVER
GRAY LADY
JOYSTICK INPUT
COSMIC SWEEPER
- ISSUE #45, MARCH 1986**
INCOME PROPERTY MGMT.
ELECTRONIC BILLBOARD 2
MOUNTAIN BATTLE
THE FIGHT
COLO KEENO
HOCKEY
LOGICAL PATTERNS
ON SCALE SCREEN
LIBERTY SHIP
SINGLE STEP RUN
- ISSUE #46, APRIL 1986**
SPECIAL EVENTS REMINDER
DISK LOCK
SMALL BUSINESS MANAGER
BOMB RUN
TANKS
TAR PITS
BASEBALL
NUMBER RELATIONSHIPS
ROULETTE
GLOBAL EDITOR
- ISSUE #47, MAY 1986**
CHRISTMAS LIST
BLACK HOLE
PITCHING MANAGER
SYMBOLIC DIFF.
BUG SPRAY
OWARE CAPTURE
EASY GRAPHICS
DESERT JOURNEY
SCREEN CONTROL
FULL ERROR MESSAGE
- ISSUE #48, JUNE 1986**
CHESTER
TV SCHEDULE
BASE RACE
ROMAN NUMERALS
ASTRO DODGE
HIRED AND FIRED
MULTI COPY
AUTO MATE
SCROLL PROTECT
NOISE GENERATOR
- ISSUE #49, JULY 1986**
COMPUTER I.O.U.
DISK DISASSEMBLER
BAKCHEK
PACHINKO
STOCK CHARTING
HAUNTED STAIRCASE
CANYON BOMBERS
DRAGONS 1 & 2
GRAPHIC SCROLL ROUTINE
AUTO BORDER
- ISSUE #50, AUGUST 1986**
BUSINESS INVENTORY
D & D ARENA
DISK CLERK
PC SURVEY
TREASURE HUNT
SCREEN GENERATOR
ASTRO SMASH
NFL SCORES
BARN STORMING
SMASH GAME
- ISSUE #51, SEPTEMBER 1986**
ASSET MANAGER
MONEY CHASE
FISHING CONTEST
RIP OFF
HAND OFF
BUDGET 51
VAN GAR
DOS EMULATOR
MEM DISK
VARIABLE REFERENCE
- ISSUE #52, OCTOBER 1986**
ACCOUNTS RECEIVABLE
WORKMATE SERIES
CALENDAR
INVASION
THE TRIP ADVENTURE
FOOT RACE
FLIPPY THE SEAL
SCREEN CALCULATOR
ABLE BUILDERS
SUPER ERROR 2
- ISSUE #53, NOVEMBER 1986**
CORE KILL
LUCKY MONEY
COOKIES ADVENTURE
NICE LIST
SPANISH QUIZZES
PAINT EDITOR
CAVERN CRUISER
SNAP SHOT
MEGA RACE
KICK GUY
- ISSUE #54, DECEMBER 1986**
JOB LOG
PEGS
DIGITAL SAMPLING
JUNGLE ADVENTURE
PAINT COCO 3
CONVERT 3
COMPUTER TYPE
PANZER TANKS
MRS PAC
BIG NUM
- ISSUE #55, JANUARY 1987**
GRADE BOOK
MAIL LIST
DOWN HILL
FIRE FOX
JETS CONTROL
GALLOWES
DIR MANAGER
FIRE RUNNER
GRAPHICS BORDER
COSMIC RAYS
- ISSUE #56, FEBRUARY 1987**
CALENDAR PRINT
CRUSH
GALACTA
OCEAN DIVER
CLUE SUSPECT
WORD EDITOR
ALIEN HUNT
DEMON'S CASTLE
PICTURE DRAW
DIG
- ISSUE #57, MARCH 1987**
THE BAKERY
ENCHANTED VALLEY ADV.
SAFE KEEPER
WAR 1
BOMB DISABLE
PIANO PLAYER
SPREAD SHEET
SLOT MANEUVER
LIVING MAZE
GEM SEARCH
- ISSUE #58, APRIL 1987**
ACCOUNTS PAYABLE
PRINTER GRAPHICS
SIMON
PANELING HELPER
MULTI CAKES
CAR RACE
ELECTRONICS I
BATTLE TANK
DISKETTE VERIFY
WEIRDO
- ISSUE #59, MAY 1987**
GENEOLOGY
HOME PLANT SELECTION
CHECK WRITER
HELIRESCUE
KABOOM
NEW PONG
CROQUET
FUNCTION KEYS
ZOOM
ELECTRONICS 2
- ISSUE #60, JUNE 1987**
JOB COSTING
LABELS
CATCH A CAKE
COCO MATCH
ROBOTS
STREET RACERS
BOWLING 3
ELECTRONICS 3
GRAFIX
KRON
- ISSUE #61, JULY 1987**
EZ ORDER
SUBMISSION WRITER
KEYS ADVENTURE
WALLPAPER
CHOPPER COMMAND
UNDERSTANDING OPPOSITES
BIT CODE PLOTTING
ELECTRONICS IV
KING PEDE
RAIDER
- ISSUE #62, AUGUST 1987**
PENSION MANAGEMENT
HERB GROWING
CATALOGUE UTILITY
RAIDERS
ALPHABETIZING
W.F.O.
ELECTRONICS V
RAMBO ADVENTURE
BLOCKS
MULTI SCREEN CAVES
- ISSUE #63, SEPTEMBER 1987**
GENEOLOGIST HELPER
SMART COPY
MAINTENANCE REPORTING
COCO 3-COCO 2 HELPER
DIRECTORY PICTURE
SUB STACK
SAVE THE MAIDEN
CAVIATOR
ELECTRONICS VI
MONKEY SHINE
- ISSUE #64, OCTOBER 1987**
GARDEN PLANTS
FORT KNOX
ELECTRONICS FORMULAS
SNAKE IN THE GRASS
CYCLE JUMP
GEOMETRY TUTOR
WIZARD
GAME OF LIFE
ELECTRONICS VII
FLIGHT SIMULATOR
- ISSUE #65, NOVEMBER 1987**
TAXMAN
DAISY WHEEL PICTURES
SIR EGGBERT
CROWN QUEST
GYM KHANA
COCO 3 DRAWER
FOOTBALL
ELECTRONICS 8
CHOP
- ISSUE #66, DECEMBER 1987**
ONE ROOM ADVENTURE
OS9 TUTORIAL
RIVER CAPTAIN
SOUND EFFECTS
BETTING POOL
ADVANCE
MATH TABLES
ELECTRONICS 9
LOWER TO UPPER
NOIDS
- ISSUE #67, JANUARY 1988**
AUDIO LIBRARY
SAVE THE EARTH
WEIGHTS AND MEASURES
LOW RES PICTURES
WORD COUNTER
BACARAT
BATTLE SHIP
ELECTRONICS 10
TAPE CONVENIENCE
PENQUIN

Gentlemen,
"I just received my first order and I am very pleased! Enclosed is a check for all the remaining back issues plus a 1-year subscription."
 Gary Rhodes
 Fontana, CA

Dear T&D,
"As the Computer Instructor for our school, I have been a subscriber to T&D software for two years. I love your programs. The quality is excellent!"
 Barry R Goblin
 Staten Island, NY

MAIL TO:

T & D Subscription Software
 2490 Miles Standish Drive
 Holland, Michigan 49424
 (616) 399-9648



Name _____

Address _____

City _____ State _____ ZIP _____

Credit Card # _____

Expires _____

TOTAL AMOUNT \$ _____

CIRCLE ISSUES DESIRED

1	9	17	25	33	41	49	57	65
2	10	18	26	34	42	50	58	66
3	11	19	27	35	43	51	59	67
4	12	20	28	36	44	52	60	
5	13	21	29	37	45	53	61	
6	14	22	30	38	46	54	62	
7	15	23	31	39	47	55	63	
8	16	24	32	40	48	56	64	

PLEASE CIRCLE
 TAPE or DISK

Listing 2: Cmdgen

```

*****
*
* CMDGEN - (c) 1987 by STEPHEN B. GOLDBERG
*
* Creates OS-9 modules which can execute the indicated
* program or series of programs, with parameter passing.
* A command line is entered at the '>' prompt. It also
* displays commands contained in the generated modules.
*
* Use: cmdgen <command.name>
*
      ifpl
      use /d0/defs/os9defs
      endc
*
      mod len,name,prgrm+objct,reent+1,entry,dsiz
*
pointer rmb 2 parameter pointer
modstart rmb 2 start of module
modlen rmb 11 module length (actual)
modname rmb 34 module name
ident rmb 77 cmdgen signature 'DG'
cmdline rmb 153 command line and CRC
maxsize equ -.modstart maximum module length
      rmb 200 stack
      rmb 200 param
dsiz equ .
*
name fcs /cmdgen/
      fcb 1 edition number
      fcc /(c)1987 S.B.Goldberg/
*****
* BEGINNING OF DUMMY MODULE
*****
dummy fdb 34765,0,13,4481,0,13058,23041
      fdb 257,257,257,257,257,257,257,257
      fdb 257,257,257,257,257,257
      fcc /BY CMDGEN/
*****
* TRANSFER CMD. LINE TO BUFFER
*****
      leas 200,u stack to direct page
*
      stx <200 save variable pointer
      leax commands,pcr command line
      leay 202,u command buffer
tfrloop lda ,x+ cmd. line character
      cmpa #0 end of line?
      beq execute yes, execute commands
      cmpa #'* wants variable?
      beq setvar yes, variable to buffer
      sta ,y+ no, character to buffer
      bra tfrloop do again
*****
* INCLUDE VARIABLE IN CMD. LINE
*****
setvar pshs x save cmd. line pointer
      ldx <200 variable address
varloop lda ,x+ variable character
      cmpa #0 end of variable?
      bne saveit no, put in buffer
      puls x get cmd. line pointer
      bra tfrloop back to transfer
saveit sta ,y+ save in buffer
      bra varloop get next var. character
*****
* EXECUTE COMMAND LINE
*****
execute sta ,y terminate commands
      leax <shell,pcr shell
      ldy #200 maximum cmd. length
      ldd #0001 type, lang., data size
      leau 202,u commands address
      os9 f$chain chain Shell
      os9 f$exit exit with error
      shell fcs /shell/
      commands equ * address of commands
      dumlen equ *-dummy length of dummy module
*****
* END OF DUMMY MODULE
*****
* DISPLAY COMMAND LINE
*****
display leax modstart,u module buffer
      ldy #maxsize maximum module length
      os9 i$read get module
      bcs passerr exit with error
      ldd ident get signature bytes
      cmpd #0447 cmdgen signature (DG)?
      bne other no, quit with prompt
      leax cmdline,u commands address
      lda #1 standard output path
      bra cmdout display commands
*****
* CMDGEN ERROR PROMPTS
*****
noname leax <syntax,pcr prompt address
errout lda #2 standard error path
cmdout ldy #150 maximum length
      os9 i$writln to screen
passerr bcs enderr exit with error
      lbra noerr quit
other leax <nocmdgen,pcr prompt address
      bra errout prompt to screen and quit
*
syntax fcc /Use: cmdgen <command.name>/
      fdb 070d
nocmdgen fcc /*** Not a CMDGEN module! /
      fdb 070d
prompt fcc /> /
*****
* CREATE NEW MODULE
*****
entry decb parameter?
      beq noname no, quit with prompt
      stx pointer command name pointer
      lda #read.+exec. mode
      os9 i$open open file, if exists
      bcc display if yes, display commands
      leax dummy,pcr start of dummy module
      leay modstart,u start of module buffer
      ldb #dumlen length of dummy module
dumloop lda ,x+ get byte
      sta ,y+ put in buffer
      decb done?

```

One-Liner Contest Winner . . .

You're locked in a high-speed car hurtling through the canyons of doom — can you safely make it through? Use the right and left arrow keys to steer.

The listing:

```

0 CLS:P=234:V=11:FORW=5TO1STEP-1
:FORN=1TOP:V=V+(RND(3)-2)*(V<>1)
)*(V<>(30-W)):PRINT@480,STRING$(V,128)
STRING$(W,32)STRING$(31-V-W,128):P=P-
(PEEK(344)=247)+(PEEK(343)=247):IFPEEK(P+1024)
<>128THENPRINT@P,"V";:NEXTN,W:PRINT"YOU WIN!"
ELSEPRINT"CRASH!"

```

Robert M. Dickau
Sacramento, CA

(For this winning one-liner contest entry, the author has been sent copies of both *The Third Rainbow Book of Adventures* and its companion *The Third Rainbow Adventures Tape*.)

```

bne dumloop no, move another byte
leax <prompt,pcr command line prompt
lda #1 standard output path
ldy #2 two characters
bsr write to screen
clra standard input path
leax cmdline,u command line buffer
ldy #15# maximum line length
os9 i$readln get command line
enderr bcs out exit with error
        cmpy #1 any entry?
        beq noerr no, quit without error
        leay 3+dumlen,y command line + dummy + CRC
        sty modlen put length in module header
        leax modstart,u start of module
        ldb #7 parity counter
        lda ,x+ get byte
eorloop eora ,x+ exclusive OR with next byte
        decb done?
        bne eorloop no, do again
        coma yes, complement
        sta ,x save in parity byte
        ldx pointer command name
        leay modname,u module name buffer
nameloop ldd ,x+ get name characters
        sta ,y+ put character in module
        cmpb #2# done?
        bhi nameloop no, move next character
        ora #1# yes, set ms bit
        sta -1,y return as last character
        leax modstart,u address of module
        ldd modlen module length

        subd #3 less CRC bytes
        tfr d,y length to Y register
        pshs u save U register
        leau d,x address of CRC accumulator
        ldd #ffff initialize
        std ,u the CRC
        sta 2,u accumulator
        os9 f$rcr do count
        bcs out exit with error
        com ,u+ complement
        com ,u+ the CRC
        com ,u bytes
        puls u retrieve U register
        ldx pointer command name
        ldd #2# mode and attributes
        os9 i$create create module file
        bcs out exit with error
        leax modstart,u module address
        ldy modlen length of module
        bsr write module to disk file
        noerr clrb clear error flag
        out os9 f$exit quit
        *****
        * OUTPUT SUBROUTINE
        *****
        write os9 i$write write
        bcs out exit with error
        rts return
        *
        emod
        len equ *
        end

```

Listing 3: Makecmdgen

```

PROCEDURE makecmdgen
  ##DIM path,byt:BYTE
  ##DIM count:INTEGER
  ##CREATE #path,"/dd/cmds/cmdgen":WRITE
  ##(* Level I use "/d#cmds/cmdgen" *)
  ##FOR count=1 TO 425
  ##  READ byt
  ##  PUT #path,byt
  ##  NEXT count
  ##  CLOSE #path
  ##  SHELL "attr /dd/cmds/cmdgen e pe"
  ##  (* Level I use "/d#cmds/cmdgen e pe" *)
  ##  END
  ##DATA 135,2#5,1,169,#,13,17,129,128,1,13,2,167,99,1#9
  ##DATA 1#8,1#3,1#1,238,1,4#,99,41,49,57,56,55,32,83,46
  ##DATA 66,46,71,111,1#8,1#8,98,1#1,114,1#3,135,2#5,#,#,#
  ##DATA 13,17,129,#,#,51,2,9#,1,1,1,1,1,1,1
  ##DATA 1,1,1,1,1,1,1,1,1,1,1,1,1,1,1
  ##DATA 1,1,1,1,1,1,1,1,66,89,32,67,77,68,71,69
  ##DATA 78,5#,2#1,#,2#8,159,2#8,48,141,#,63,49,2#1,#,2#2
  ##DATA 166,128,129,13,39,26,129,42,39,4,167,16#,32,242,52
  ##DATA 16,158,2#8,166,128,129,13,38,4,53,16,32,228,167,16#
  ##DATA 32,242,167,164,48,14#,17,16,142,#,2#8,2#4,#,1,51
  ##DATA 2#1,#,2#2,16,63,5,16,63,6,115,1#4,1#1,1#8,236,48
  ##DATA 66,16,142,1,21,16,63,137,37,27,22#,49,16,131,68
  ##DATA 71,38,24,48,2#8,126,134,1,32,5,48,14#,19,134,2
  ##DATA 16,142,#,15#,16,63,14#,37,114,22,#,2#5,48,14#,3#
  ##DATA 32,237,85,115,1#1,58,32,99,1#9,1#8,1#3,1#1,11#,32,6#
  ##DATA 99,111,1#9,1#9,97,11#,1#8,46,11#,97,1#9,1#1,62,7,13
  ##DATA 42,42,42,42,32,78,111,116,32,97,32,67,77,68,71
  ##DATA 69,78,32,1#9,111,1#8,117,1#8,1#1,33,7,13,62,32,9#
  ##DATA 39,174,159,#,134,5,16,63,132,36,139,48,141,255,11
  ##DATA 49,66,198,124,166,128,167,16#,9#,38,249,48,14#,224,134
  ##DATA 1,16,142,#,2,141,1#9,79,48,2#8,126,16,142,#,15#
  ##DATA 16,63,139,37,93,16,14#,#,1,39,86,49,168,127,16
  ##DATA 159,4,48,66,198,7,166,128,168,128,9#,38,251,67,167
  ##DATA 132,158,#,49,79,236,128,167,16#,193,32,34,248,138,128
  ##DATA 167,63,48,66,22#,4,131,#,3,31,2,52,64,51,139
  ##DATA 2#4,255,255,237,196,167,66,16,63,23,37,26,99,192,99
  ##DATA 192,99,196,53,64,158,#,2#4,6,47,16,63,131,37,8
  ##DATA 48,66,16,158,4,141,4,95,16,63,6,16,63,138,37
  ##DATA 248,57,39,122,123

```

One-Liner Contest Winner . . .

This shortie provides a chart of loan payments. Just enter the principal, number of months you'll be paying on the loan and the interest rate percentage, and the program produces a table of interest and principal payments. The screen displays only 12 months at a time, so press ENTER to see the next 12.

The listing:

```

3 CLS:INPUT"AMT,MNTHS,PCT":A,M,R
:R=R/12#P:P=A/((1-(1/(1+R)^M))
/R):PRINT@35,"BAL PRIN IN
T PAY":FORN=1TOM:S=R*A:A=A-P
+S:PRINTUSING"#####.###.###.###
#####.###":A,P-S,S,P:IFN=I
NT(N/12)*12THENINPUT">":AS:PRINT
@64,,:NEXT:ENDELSENEXT:END

```

Stuart Hawkinson
Aloha, OR

(For this winning one-liner contest entry, the author has been sent copies of both *The Third Rainbow Book of Adventures* and its companion *The Third Rainbow Adventures Tape*.)

Racksellers

The retail stores listed below carry THE RAINBOW on a regular basis and may have other products of interest to Tandy Color Computer users. We suggest you patronize those in your area.

ALABAMA

Birmingham Jefferson News Co.
Brewton McDowell Electronics
Florence Anderson News Co.
Greenville M & B Electronics
Madison Madison Books
Montgomery Trade 'N' Books
Tuscaloosa Injun John's, Inc.

ALASKA

Fairbanks Electronic World

ARIZONA

Coltonwood A & W Graphics Co.
Lake Havasu City
Phoenix Book Nook
Sierra Vista TRI-TEK Computers
Tempe Livingston's Books
Tempe Books, Etc.
Tucson Computer Library
Anderson News Co.

ARKANSAS

Fayetteville Vaughn Electronics/Radio Shack
Ft. Smith Hot Off the Press Newsstand
Little Rock Anderson News Co.

CALIFORNIA

Berkeley Lyon Enterprises
Citrus Heights Software Plus
Grass Valley Advance Radio, Inc.
Half Moon Bay Strawflower Electronics
Hollywood Levy Distributors
Stef-Jen, Inc.
La Jolla Butler & Mayes Booksellers
Los Angeles Circus of Books (2 Locations)
Marysville Bookland
Napa Bookends Bookstore
Oakland DeLauer's News Agency
Sacramento Delbert's Readerama
Tower Magazine
San Francisco Booksmith
Bookworks
Castro Kiosk
Santa Monica Midnight Special Bookstore
San Jose Computer Literacy Bookshops
Santa Rosa Sawyer's News, Inc.
Stockton Harding Way News
Paperbacks Unlimited
Sunnyvale Computer Literacy
Torrance El Camino College Bookstore

COLORADO

Aurora Aurora Newsstand
Colorado Springs Hathaway's
Denver News Gallery
Glenwood Springs The Book Train
Grand Junction Readmore Book & Magazine
Longmont City Newsstand

DELAWARE

Middletown Delmar Co.
Newark Newark Newsstand
Wilmington Normar, Inc.—The Smoke Shop

DISTRICT OF COLUMBIA

Washington, DC Chronichles
News Room
World News, Inc.

FLORIDA

Boca Raton Great American Book Co.
Clearwater The Avid Reader
Cocoa The Open Door
Danla Danla News & Books
Davie Software Plus More
Ft. Lauderdale Bob's News & Book-Store
Clarks Out of Town News
Mike's Electronics Distributor
Paper Chase
Book Co.
Gainesville Almar Bookstore
Jacksonville Boyd-Ebert Corp.
North Miami Anderson News Co.
Beach Wolf's Newsstand
Panama City
Pensacola
Pinellas Park
South
Pasadena Polling Place Bookstore
Starke Record Junction, Inc.
Radio Shack Dealer

FLORIDA (cont'd)

Sunrise Sunny's at Sunset
Tallahassee Anderson News Co.
DuBey's News Center
Computrac

FLORIDA

Titusville
Atlanta Border's
Bremen Bremen Electronics/Radio Shack
Forest Park Ellers News Center
Jesup Radio Shack
Thomasville Smokehouse Newsstand
Toccoa Martin Music Radio Shack

IDAHO

Boise Book Shelf, Inc.
Moscow Johnson News Agency

ILLINOIS

Belleville Software or Systems
Champaign Bookmark
Chicago B. Dalton Booksellers
Decatur Book Emporium
K-Mart Plaza
Northgate Mall
Book Emporium
Book Emporium
Norris Center Bookstore
Book Emporium
Book Nook
Empire Periodicals
Bill's TV Radio Shack
Book Emporium
Book Emporium
Sheridan Village
Westlake Shopping Center
Illinois News Service
Book Emporium
Sangamon Center North
Town & Country Shopping Ctr.
Book Emporium
Paper Place
North Shore Distributors
Springfield

INDIANA

Angola D & D Electronics
Radio Shack
Berne White Cottage Electronics
Book Corner
Bloomington Micro Computer Systems, Inc.
Columbus Koch's Books
Crawfordsville Miles Books
Dyer Gallery Book Shop
Franklin Michiana News Service
Ft. Wayne Finn News Agency, Inc.
Garrett Bookland, Inc.
Indianapolis Borders Bookshop
Delmar News
Indiana News
Southside News
Gallery Book Shop
Radio Shack
Wabash Milting's Electronics

INDIANA

Lebanon
Martinsville
Wabash

IOWA

Davenport Interstate Book Store
Des Moines Thacker's Books, Inc.
Fairfield Kramers Books & Gifts

KANSAS

Hutchinson Crossroads, Inc.
Topeka Palmer News, Inc.
Town Chief of Topeka, Inc.
Dandy's/Radio Shack Dealer
Lloyd's Radio
Wellington
Wichita

KENTUCKY

Hazard Daniel Boone Gulf Mart
Henderson Matt's News & Gifts
Hopkinsville Hobby Shop
Louisville Hawley-Cooke Booksellers (2 Locations)
Paducah Radio Shack

LOUISIANA

Baton Rouge City News Stand
New Orleans Sidney's News Stand Uptown
Monroe The Book Rack

MAINE

Bangor Magazines, Inc.
Brockton Voyager Bookstore
Caribou Radio Shack
Oxford Books-N-Things
Sanford Radio Shack

MARYLAND

College Park University Bookstore

MASSACHUSETTS

Boston Eastern Newsstand
Brockton Voyager Bookstore
Cambridge Out of Town News
Ipswich Ipswich News
Littleton Computer Plus
Lynn North Shore News Co.
Swansea Newsbreak, Inc.

MICHIGAN

Allen Park Book Nook, Inc.
Birmingham Border's Book Shop
Durand Robbins Electronics
E. Detroit Merit Book Center
Harrison Harrison Radio Shack
Hillsdale Electronics Express/Radio Shack
Holland Fris News Company
Lowell Curt's Sound & Home Arcade Center
Muskegon The Eight Bit Corner
Niles Michiana News Service
Perry Perry Computers
Riverview Riverview Book Store
Roseville New Horizons Book Shop

MINNESOTA

Burnsville Shinder's Burnsville
Crystal Shinder's Crystal Gallery
Edina Shinder's Leisure Lane
Minneapolis Shinder's (2 Locations)
Minnetonka Shinder's Ridge Square
Roseville Shinder's Roseville
St. Paul Shinder's Annex
Shinder's Maplewood
Shinder's St. Pauls
The Photo Shop
Willmar

MISSOURI

Farmington Ray's TV & Radio Shack
Flat River Ray's TV & Radio Shack
Florissant Book Brokers Unlimited
Jefferson City Cowley Distributing
Kirksville T&R Electronics
Moberly Audio Hut
St. Louis Book Emporium
St. Robert Bailey's TV & Radio

MONTANA

Butte Plaza Books

NEBRASKA

Lincoln Nebraska Bookstore
Omaha Nelson News

NEVADA

Carson City Bookcellar
Las Vegas Hurley Electronics
Steve's Books & Magazines

NEW HAMPSHIRE

Keene Radio Shack Associate Store
Manchester Bookwrights
West Lebanon Verham News Corp.

NEW JERSEY

Atlantic City Atlantic City News Agency
Cedar Knolls Village Computer & Software
Clinton Micro World II
Pennsville Dave's Elect. Radio Shack
Rockaway Software Station

NEW MEXICO

Alamogordo New Horizons Computer Systems
Albuquerque Page One Newsstand
Santa Fe Downtown Subscription

NEW YORK

Amherst Village Green-Buffalo Books
Brookport Lift Bridge Book Shop, Inc.
Brooklyn Cromland, Inc.
Elmira Southern Tier News Co., Inc.
Fredonia On Line Computer Access Center
Hudson Falls G.A. West & Co.
Huntington Oscar's Bookshop
Johnson City Unicorn Electronics
Barnes & Noble—Sales Annex
Coliseum Books
Eastern Newsstand
Grand Central Station, Track 37
200 Park Ave., (Pan Am #1)
55 Water Street
World Trade Center #2
First Stop News

NEW YORK (cont'd)

Idle Hours Bookstore
International Smoke Shop
Jonil Smoke
Penn Book
Software City
State News
Walden Books
World Wide Media Services
Universal Computer Service
Village Green
World Wide News
Spectrum Projects

Pawling
Rochester

Woodhaven

NORTH CAROLINA

Cary News Center in Cary Village
University News & Sundry
Charlotte Newsstand Int'l
C² Books & Comics
Hickory Michele's, Inc.
Jacksonville K & S Newsstand
Kernersville Boomers Rhythm Center
Marion K & S Newsstand (3 Locations)
Winston-Salem Rainbow News Ltd.

OHIO

Akron Churchill News & Tobacco
Canton Little Professor Book Center
Chardon Thrasher Radio & TV
Cincinnati Cinsoff
Cleveland Erieview News
Columbiana Fidelity Sound & Electronics
Columbus B5 Software
Micro Center
The Newsstand

Dayton

Books & Co.
Huber Heights Book & Card
Wilke News
Wright News & Books
Book Barn
News-Readers
Wilke's University Shoppe

Dublin

Fairborn Open Book
Findley The News Shop
Kent Lakewood International News
Lakewood Edu-Caterers
Lima Wilke News
Miamisburg Bookmark Newscenter
Parma Leo's Book & Wine Shop
Toledo Book Nook, Inc.
Warren Fine Print Books
Xenia Plaza Book & Smoke Shop
Youngstown

OKLAHOMA

Oklahoma Merit Micro Software
City Thomas Sales, Inc. dba Radio Shack
Tulsa Steve's Book Store

OREGON

Eugene Libra Books — Book Mark
Portland Fifth Avenue News
Rich Cigar Store, Inc.
Sixth & Washington News
Capital News Center
Checkmate Book

Salem

PENNSYLVANIA

Allentown Owl Services
Alltoona Newborn Enterprises
Bryn Mawr Bryn Mawr News
Feasterville Global Books
King of Prussia Gene's Books
Malvern Personal Software
Reading Smith's News & Card Center
Temple Software Corner
West Chester Chester County Book Co.
Wind Gap Micro World
York The Computer Center of York
Tollgate Bookstore

RHODE ISLAND

Newport Bellevue News

SOUTH CAROLINA

Charleston Hts. Software Haus, Inc.
Clemson Clemson Newsstand
Florence Ray's #1
Greenville Palmetto News Co.
Spartanburg Software City

TENNESSEE

Brentwood Bookworld #5
Chattanooga Anderson News Co.
Guild Books & Periodicals
Dickson Highland Electronics
Knoxville Anderson News Co.
Davis-Kidd Bookseller
Computer Center
Memphis Davis-Kidd Booksellers
Nashville Mosko's Place
R.M. Mills Bookstore
Delker Electronics

Smyrna

TEXAS

Big Spring Poncho's News
Desoto Maxwell Books
Elgin The Homing Pigeon
Harlingen Book Mark

UTAH

Provo Valley Book Center

VIRGINIA

Danville K & S Newsstand
Hampton Benders
Norfolk I-O Computers
Turn The Page
Richmond Volume I Bookstore

WASHINGTON

Port Angeles Port Book & News
Seattle Adams News Co., Inc.
Bulldog News
Tacoma B & I Magazines & Books
Nybbles 'N Bytes

WEST VIRGINIA

Huntington Nick's News
Logan Stan's Electronics & Radio Shack
Madison Communications, LTD
Parkersburg Valley News Service
South Spring Hill News
Charleston

WISCONSIN

Appleton Badger Periodicals
Cudahy Cudahy News & Hobby
Kenosha R.K. News, Inc.
Madison Pic A Book
University Bookstore
Juneau Village Reader
Waukesha Holt Variety

ARGENTINA

Cordoba Information Telecommunications

AUSTRALIA

Blaxland Blaxland Computers
Kingsford Paris Radio Electronics

CANADA-ALBERTA

Banff Banff Radio Shack
Bonnyville Paul Tierci
Brooks Double "D" A.S.C. Radio Shack
Calgary Billy's News
Claresholm Radio Shack Associated Stores
Drayton Valley Langard Electronics
Edmonton CMD Micro
Fairview Radio Shack, asd
Fox Creek D.N.R. Furniture & TV
Fox City Color & Sound
A.S.C. Radio Shack

Ft. Saskatchewan

Ft. Mail Radio Shack, ASC

Grande Cache

The Stereo Hut

Grande Centre

The Book Nook
Jim Cooper
L & S Stereo
Brian's Electronics
Radio Shack Associated Stores
Dataron
Lloyd Radio Shack
Okotoks Okotoks Radio Shack
Radio Shack Associated Stores
Taverner Software
Walter's Electronics

St. Paul

Steffler Steffler Radio Shack
Strathmore Wheatland Electronics
Taber Pynewood Sight & Sound
Westlock Westlock Stereo
Wetaskiwin Radio Shack

BRITISH COLUMBIA

Burnaby Compulift
Burns Lake VT. Video Works
Campbell River TRS Electronics

BRITISH COLUMBIA (cont'd)

Chilliwack Charles Parker
Coquitlam Cody Books LTD
Coortenay Rick's Music & Stereo
Dawson Creek Bell Radio & TV
Golden Taks Home Furnishings
Kelowna Telesoft Marketing
Langley Langley Radio Shack
Nelson Oliver's Books
New Westminster Cody Books LTD
Parksville Parksville TV
Penticton D.J.'s
Four Corner Grocery
Sidney Sidney Electronics
Smithers Wall's Home Furniture
Squamish Kotyk Electronics
Vancouver Active Components
Friendlyware Computers
Granville Book Co.
Siliconconnections Books LTD

100 Mile House
Tip Top Radio & TV

MANITOBA

Altona L.A. Wiebr Ltd.
Lundar Goranson Elec.
Morden Central Sound
The Pas Jodl's Sight & Sound
Selkirk G.L. Enns Elec.
Virden Archer Enterprises
Winnipeg J & J Electronics Ltd.

NEW BRUNSWICK

Moncton Jeffries Enterprises
Sussex Dewitt Elec.

NEWFOUNDLAND

Botwood Seaport Elec.
Carbonear Slade Realties

NOVA SCOTIA

Halifax Atlantic News

ONTARIO

Angus Micro Computer Services
Aurora Compu Vision
Concord Ingram Software
Exceter J. Maclean & Sons
Hanover Modern Appliance Centre
Huntsville Huntsville Elec.
Kenora Donny "B"
Kingston T.M. Computers
Listowel Modern Appliance Centre
South River Max TV
Dennis TV

QUEBEC

LaSalle Messageries de Presse Benjamin Enr.
Pont. Rouge Boutique Bruno Laroche
Ville St. Gabriel Gilles Comeau Enr./Radio Shack

SASKATCHEWAN

Assiniboia Telstar News
Estevan Kotyk Electronics
Moose Jaw D&S Computer Place
Nipiwana Cornerstone Sound
Regina Regina CoCo Club
Software Supermarket
Saskatoon Everybody's Software Library
Shellbrooke Gec. Laberge Radio Shack
Tisdale Paul's Service
Unity Grant's House of Sound

YUKON

Whitehorse H & O Holdings

JAPAN

Tokyo America Ado, Inc.

PUERTO RICO

San Juan Software City

Also available at all B. Dalton Booksellers, and selected Coles — in Canada, Waldenbooks, Pickwick Books, Encore Books, Barnes & Noble, Little Professors, Tower Book & Records, Kroch's & Brentano's, and Community Newscenters.

Advertisers Index

We encourage you to patronize our advertisers — all of whom support the Tandy Color Computer. We will appreciate your mentioning THE RAINBOW when you contact these firms.

After Five Software	133	Other Guys CoCo, The	101	Software House, The	133
Alpha Products	21	Owl-Ware	69, 70, 71	SpectroSystems	149
Bill Bernico	56	Performance Peripherals	61	Speech Systems	46, 47
Bob's Software	129	Perry Computers.....	179	SPORTSWARE	85
Burke & Burke	89	Preble's Programs, Dr.	BC	Sugar Software	105
Cer-Comp	183	Public Domain	166	Sundog Systems	39
Cinsoft	175	PXE Computing	7	T & D Software.....	87, 186, 187
CJN Enterprises	37	R.A.D. Products	31	Tandy/Radio Shack	26, 27
Clearbrook Software Group	129	R.G.B. Computer Systems	123	Tepeco	83
CoCo Cat Anti Drug.....	103	R.J.F. Software	55	Three C's Projects	25
CoCo Gallery Live	49	Rainbow Binder.....	180	Tom Mix Software	193
Cocotech.....	123	Rainbow Bookshelf	172	Tomela & Co.....	137
Cognitec	29	Rainbow Gift Subscription	57	Tothian Software.....	33
Colorware	22, 23	Rainbow on Tape and Disk	119	True Data Products.....	144, 145
Computer Center	107	RAINBOWfest	50, 51	Vidicom Corporation	75
Computer Island	111	Sardis Technologies	171	Woodstown Electronics	175
Computer Plus	3	SD Enterprises	67, 77, 121	Zebra Systems.....	173
Computerware.....	167	SEESOF.....	143		
D.P. Johnson	181				
Dayton Associates of W. R. Hall, Inc.	134, 135				
Delphi	34, 35				
Diecom.....	IFC, IBC				
Disto/CRC	177				
E.Z. Friendly Software.....	125				
Electronic Energy Control	73				
Frank Hogg Laboratory	40, 41				
Gimmesoft	139				
Glen Calafati	137				
Hard Drive Specialists	17				
Hawkes Research Services	149				
Howard Medical	66, 194				
J & R Electronics	166				
K—SOFT	45				
KLC Software	75				
Metric Industries	115				
Micro Works, The	109				
Microcom Software	9, 11, 13, 15				
Microtech Consultants Inc.	163				
MicroWorld	113				
NRI Schools	99				

 **Call:**
Belinda Kirby
Advertising Representative
 The Falsoft Building
 9509 U.S. Highway 42
 P.O. Box 385
 Prospect, KY 40059
(502) 228-4497

 **Call:**
Kim Vincent
Advertising Representative
 The Falsoft Building
 9509 U.S. Highway 42
 P.O. Box 385
 Prospect, KY 40059
(502) 228-4492





TOM MIX COMPANIES

- FLIGHT 16***† - This is the very finest flight simulation program on the market today. Flight 16 will work with all color computers. Flies very much like a Cessna 150. As a full instrument aircraft with sound effects and out-of-the-window graphics. As a REAL bonus feature, you may design your own airports and flight areas.
\$34.95 32K
- WORLDS OF FLIGHT****† - A real-time flight simulation of a sophisticated ultra-light aircraft which generates panoramic 3-D views of ground features as you fly in any of nine different "worlds." The manual included explains the instrument panel, the basis of flight control, etc. For the serious simulation buff!
\$30.95 32K
- P51 MUSTANG ATTACK/FLIGHT SIMULATION***† - The ultimate video experience! For the first time ever, two CoCo's can be linked together via cable modem. (If playing via modem, both computers require a copy of the program.) Or play alone and sharpen your skills against a non-combatant computer drone.
\$30.95 32K
- APPROACH CONTROL SIMULATION*** - "Caught in a blinding snowstorm, two jet airliners are on a collision course. Hundreds of lives are at stake! A high-speed disaster is inevitable unless you act fast. . . ." This and many other scenarios await you as the Air Traffic Controller. Experience firsthand challenges, frustrations and pressures felt by all Air Traffic Controllers!
\$25.95 32K
- THE KING****† - This is a color computer classic! Looks and plays like the popular arcade game. Contains the same four screens as the original: barrels, pins, jacks, and conveyors. Super graphics!
\$25.95 32K
- TRAPFALL****† - The "pitfalls" in this game are many. Fight your way through the jungle collecting hidden treasures as you go.
\$20.95 16K
- KATERPILLAR II****† - The CoCo has needed a perfect centipede-type game since day one. You will throw all imitations aside when you see this.
\$20.95 16K
- BUZZARD BAIT****† - We've done it again. Outstanding high resolution graphics and sound make this "joust" type game a must for your software collection. One or two players.
\$20.95 32K
- MS. MAZE****† - Ms. Maze combines brilliant color, high resolution, detailed graphics and music to make it look and play like the arcade version. It is the closest thing to the arcade Pac games that we've seen for the CoCo! Arcade Aces — this one's for you!
\$20.95 32K
- CUBER****† - The hazards faced by Cuber are many! Help him change the colors of the pyramid while avoiding the many dangers always present.
\$20.95 32K
- VEGAS GAME PAK****† - Now you can bring Las Vegas home with you! This package contains six different games: Video Keno, Video Poker, and Video Blackjack, plus three slot machine lookalikes, Bar 5, 3 Line, and Right/Left.
\$24.95 16K
- GOLD FINDER****† - Here's the quality you have come to expect from TOM MIX! While avoiding enemies, pick up all the pieces of gold along the way; then ride the elevator to the top to solve each level. Sixty-nine levels. PLUS now you can create your own levels.
\$20.95 32K Disk only
- THE SAILOR MAN****† - Avoid the punches of the Bigfatbadguy and the flying bottles thrown by the Oldgullyseawoman to rescue Elsie and win her heart! One or two players. More great sound and graphics from the author of "The King!"
\$25.95 64K
- elec*TRON****† - Patterned after the popular arcade game, there are four men on your team and four subgames to complete.
\$20.95 16K
- THE WILD WEST - CoCo III Only** - The notorious desperado Black Bart has escaped from jail and is on his way to Dry Gulch to recover his hidden fortune. Can you capture him? Four voice music and sound effects and a vocabulary of over 100 words!
\$20.95 Disk only
- WIZARD'S DEN*** - Another of our outstanding graphic adventures! You must recover the Gem of Damocles, stolen by the Evil Wizard. His magic is strong and he can make you see things that don't exist!
\$20.95 64K Disk only
- LUNCHTIME****† - Your chef, Peter Pepper, is surrounded! Dodge pickles, hot dogs and eggs while building hamburgers. Fast paced action for either one or two players.
\$19.95 32K
- BREWMASTER****† - Move along the end of the bars serving beers to your thirsty customers, but watch out for falling glasses and rowdy customers!
\$15.95 32K
- MAUI VICE****† - Step into the shoes of Crock and Bubbs in this graphic adventure and gather evidence. A new story generated each time you play!
\$20.95 64K extended basic, Disk only
- CHAMBERS****† - Loosely based on Cosmic Chasm, in each level you must destroy all of the evil creatures. In all there are 20 series of chambers with 20-35 interconnected rooms.
\$15.95 32K
- DRAGON SLAYER*** - Save the villagers of Pendor from Icarus, the bloodthirsty dragon! He lives in a cave way up in the mountains, which is a treasure chest full of gems and cashbags. Be on the lookout for enemies and barriers at all times! Ten levels with sixteen rooms per level; over 160 exciting screens.
\$20.95 32K Disk only
- VEGAS SLOTS - CoCo III Only** - Seven of the most popular slot machine games found in Vegas are yours for the price of one: MultiBars, Fruit MultiBars, Right-Left/Left-Right, Lucky Dollar, Melons and Bars, Fruit and Bar 5. Designed to be as real as being there. One of the most outstanding programs we have ever offered.
\$29.95 Disk only
- VIDEO CARDS & KENO - CoCo III Only** - Play Video Poker, Jokers Wild, Blackjack, and Keno. These games are so real you expect to see Wayne Newton walk by! Outstanding graphics and movement. Wanna Bet?
\$29.95 Disk only
- TEACHERS DATABASE II*** - Allows teachers to keep computerized files of students. • Up to 100 students, 24 items per student • Statistical analysis of scores • Grades can be weighed, averaged, percentaged • Test result graphs/grade distribution charts
\$59.95 64K TDBII Disk Only
\$42.95 32K TDB

SPECIAL OFFER:

Order two, take \$5.00 off total
Three or more, take \$8.00 off total

ARCADE GAME SALE

NOW! Here's your chance to have your own collection of Arcade favorites:

Package #1

Donkey Kong
Centipede
Pitfall
Donut Dilemma
Joust

\$49.95

Package #2

Popeye
Ms. Pacman
Tron
Burger Time
Q*Bert

\$49.95

Package #3

Pacman
Frogger
Quix
Bartender
Loderunner

\$49.95

OR: 2 packages only \$94.95; 3 packages only \$139.95

Each package contained on more than one unprotected diskette (Sorry, disk only). This is high quality software that formerly sold for as high \$34.95 each.

Please add \$4.00 shipping on this special offer only.



* CoCo 1, 2, 3 compatible
† Joystick required
Write for free catalog

More educational software available.
TOM MIX SOFTWARE
P.O. Box 201
Ada, Michigan 49301
616/676-8172

- Specify tape or disk when ordering
- Add \$3.00 postage/handling
- MI residents add 4% sales tax

CONTROLLERS

The DC-4 is a scaled-down version of the popular DC-2 without a parallel port. It includes a switch with 2 ROM sockets, JDOS, manual and such features as gold connectors and metal box. It accesses double sided drives and accepts RSDOS 1.1 for Radio Shack compatibility

\$65 (\$2 Shipping)

RS 1.1 R.S. ROM Chip \$25



DC-2

J&M Disk Controller with parallel port/Hard Drive expansion bus makes a revival with the CoCo 3.

\$98 (\$2 Shipping)

DISK DRIVE SPECIALS

DRIVE 0 +

Howards Drive 0 gives you a DD-3 MPI drive, a CA-1 cable and a J&M DC-4 Disk Controller for only. Add \$34 for a Disto DC-3 replacement. (\$5 shipping)

\$178.45

DOUBLE SIDED
DOUBLE DENSITY
360K



Separate Disk Drive Components

DD-3 An MPI 52 double-sided, double density, 360K disk drive in a full height case and heavy-duty power supply.

\$98 (\$2 shipping) **DRIVE ONE**

NEW FROM DISTO \$129 DC6 (\$2 Shipping)

Super Controller II works with CoCo 1, 2 & 3. It buffers keyboard input so that no keystrokes are lost when disk is reading or writing. Especially useful with OS-9, but also works with BASIC.

TEAC 55B bare drive, 1/2 height, double-sided, double density with all mounting hardware, needs CA-2 below to fit R.S. 501.

\$118 (\$2 shipping) **BARE**

SP-C

Serial to parallel converter converts the CoCo 4 pin serial output to run a parallel printer like Star or Epson. Includes all cables. Add \$10 for modem attachment.

(\$2 shipping) **\$68.45**

CA-1 Cable that connects the disk controller to the drive.

\$24.95
One Drive

CA-2 **\$29.95**
Two Drive

GUARANTEE — Howard Medical's 30-day guarantee is meant to eliminate the uncertainty of dealing with a company through the mail. Once you receive our hardware, try it out, test it for compatibility. If you're not happy with it for any reason, return it in 30 days and we'll give you your money back (less shipping).

This space could feature YOUR Hardware Project. Call Chike at HMC for details

WORD PACK RS

\$49

BASIC SCREEN EDITOR

\$19.95

- Looks like Atari screen editor
- Works on CoCo 1, 2 & 3
- Now with 80 column support

MYDOS by Chris Hawks

\$15

- Simplify your directory
- Accesses double sided drives
- Use J&M Printer Port on CoCo 3

CoCo MAX by Colorware

\$78.45

- Specify II or III
- Includes high res interface
- Animation
- Printers supported include, R.S. 105, 106, 130; Star; & Epson

(\$2 shipping on software)

MONITORS

Sony KV-1311CR

\$499

Regular \$695
(\$15 shipping)

- Vivid Color
- Vertically flat 13" screen
- Monitor/Trinitron TV with remote control
- 640 X 240 resolution at 15MHZ .37 mm Dot pitch
- RGB analog & digital TTL; and composite inputs
- VCR inputs
- Cable to CoCo 3 \$36

MAGNAVOX 7622

\$88

12" Amber Screen offers 900 dots x 350 lines resolution at 20 MHz on a dark glass anti-glare CRT with built-in audio and 1 year warranty.

(\$7 Shipping)

7652 Green Screen • Same Specs • Same Price

20 MEG HARD DRIVE

- pre-Installed, formatted and ready to run
- equivalent to 125 R.S. 501's on line
- Includes Western Digital WD1002-WK1 Controller
- and Seagate 20 Meg Hard Drive
- will also work with IBM & clones
- complete package includes 20 meg drive, case & power supply, controller and interface that plugs into slot #3 of multipack interface.
- 1 year warranty

\$699

\$499

(\$9 Shipping)

BASIC driver lets you access this hard drive without need for OS-9 \$49.95

Howard Medical Computers 1690 N. Elston Chicago, IL 60622



ORDERS

(800) 443-1444

INQUIRIES AND ORDER STATUS

(312) 278-1440

Showroom Hours:
8:00 - 5:00 Mon. - Fri.
10:00 - 3:00 Sat.

WE ACCEPT: VISA • MASTERCARD • AMERICAN EXPRESS
C.O.D. OR CHECKS • SCHOOL P.O.'S

Shipping charges are for 48 states.
APO and Canada order slightly higher.



DIECOM PRODUCTS INC.

HIGH SCORE	76,550
PLAYER 1 ENERGY	14,588
BULLETS	47
GRENADES	59
PLAYER 2 ENERGY	9,258
BULLETS	71
GRENADES	38

Requires 64 k and one joystick. For the Coco 1, 2 or 3

GRAND PRIX CHALLENGE

Race alone against the computer, or with a friend against the computer in this high speed racing game. You compete in 5 lap races around twisting and turning race courses. Finish the race ahead of all the computer cars and you will progress to a more challenging course. Collect repair tools as you race around the track and you will be able to increase the speed and handling of your race car. But watch out for oil slicks and water puddles on the track or you might find your car crashing into a wall. Detailed 320 x 200 graphics and realistic driving conditions make this a must for your Coco 3 collection. Many different race tracks will keep you challenged.

Disk **\$28.95 U.S. \$38.95 Can.**

MISSION: RUSH'N ASSAULT

One or two players can take on the mission to rescue POW'S hidden deep inside enemy territory. Watch out for enemy soldiers, snipers, grenade launchers and many other hazards as you journey farther over enemy lines. Forge your way through jungles and swamps and other hazardous terrain as you search for the missing soldiers. Pick up grenades, extra ammo and more powerful weapons as you continue farther into your mission. The enemy is out in great force to stop your mission. Dozens of screens will keep you playing for hours. Can you succeed and rescue the prisoners? Only time will tell!

Tape or Disk
**\$28.95 U.S.
\$38.95 Can.**

LAP # 2 SCORE 4,550

LAP # 2 SCORE 4,980

Requires 128 k Coco 3 with one joystick.

GANTELET II

It's back and better than ever. It's Gantelet II for your Coco 3. Using 320 x 200 hi-res graphics with 16 colors, we have created one of the best arcade style games you will ever see for your Coco. Four people can now play simultaneously in one game. Dozens of new levels with new monsters will challenge even the best players. Collect keys to open doors and chests, treasures, and many new magic potions to help you battle more powerful monsters. Watch out for hidden traps as you search for the exit to next level.

Tape or Disk **\$28.95 U.S. \$38.95 Can.**

WIZARD	HEALTH: 7,300	SCORE: 7770
ELF	HEALTH: 5,850	SCORE: 451
VALKYRIE	HEALTH: 6000	SCORE: 451
WARRIOR	HEALTH: 6,475	SCORE: X2
	HEALTH: 6,750	SCORE: 6,750

Requires 128 k Coco 3

NEW LOW PRICE ON CALADURIL FLAME OF LIGHT & LANSFORD MANSION, AVAILABLE ON DISK ONLY
**\$28.95 U.S.
\$38.95 Can.**

CALADURIL FLAME OF LIGHT

For the Coco 1, 2 or 3

LANSFORD MANSION

For the Coco 1, 2 or 3

ALSO AVAILABLE: MISSION: F-16 ASSAULT • PAPER ROUTE • KNOCK OUT • KARATE • MARBLE MAZE

**\$28.95 U.S.
\$38.95 CAN.**
AVAILABLE ON TAPE OR DISK
64K REQUIRED

DIECOM PRODUCTS INC.

6715 FIFTH LINE, MILTON, ONT., CANADA L9T 2X8

24 hr. order line:
(416) 878-8358
personal service 9-5

Please add \$2 shipping & handling (for 'The Rat' and 'Iron Forest' add \$5 each for shipping). Ontario residents add 7% sales tax. C.O.D. Canada only.



SEE FRONT COVER FOR OTHER DIECOM GAMES

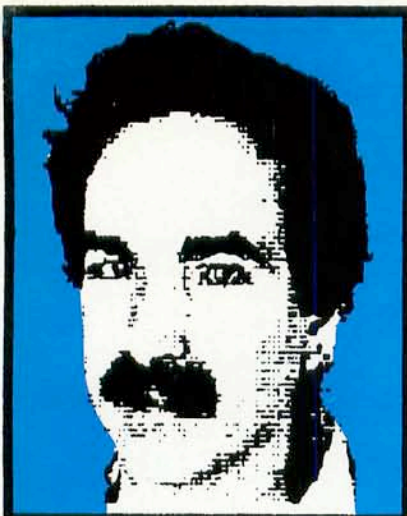

Dear Friends,

Thank you. 1988 marks our fifth year of providing quality software for the Color computer. Only your support has made it possible. So, from our hearts, Peg and I thank you. And remember our promise--If you buy it from us, we support it. If you are unhappy for any reason, send it back for a full refund within 30 days of purchase.

Pyramix

This fascinating CoCo 3 game continues to be one of our best sellers. Pyramix is 100% machine language written exclusively to take advantage of all the power in your 128K CoCo 3. The Colors are brilliant, the graphics sharp, the action fast. Written by Jordon Tsvetkoff and a product of Color-Venture.

The Freedom Series

Vocal Freedom

I've got to admit, this is one nifty computer program. Vocal Freedom turns your computer into a digital voice or sound recorder. The optional **Hacker's Pac** lets you incorporate voices or sounds that you record into your own BASIC or ML programs. This is not a synthesizer. Sounds are digitized directly into computer memory so that voices or sound effects sound very natural. One "off-the-shelf" application for Vocal Freedom is an automatic message-minder. Record a message for your family into memory. Set Vocal Freedom on automatic. When Vocal Freedom "hears" any noise in the room, it

Dr. Preble's Programs

For Color Computer Software
Since 1983

plays the pre-recorded message! Disk operations are supported. VF also tests memory to take advantage of from 64K up to a full 512K. Requires low cost amplifier (RS cat. #277-1008) and any microphone.

Mental Freedom

Would your friends be impressed if your computer could read their minds? Mental Freedom uses the techniques of Biofeedback to control video game action on the screen. Telekinesis? Yes, you control the action with your thoughts and emotions. And, oh yes, it talks in a perfectly natural voice without using a speech synthesizer! Requires Radio Shack's low cost Biofeedback monitor, Cat. #63-675.

BASIC Freedom

Do you ever type in BASIC programs--manually, I mean. If you do, you know it can be a real chore. Basic Freedom changes all that. It gives you a full screen editor just like a word processor, but for BASIC programs. Once loaded in, it is always on-line. It hides invisibly until you call it forth with a single keypress! This program is a must for programmers or anyone who types in programs. By Chris Babcock and a product of Color-Venture.

Lightning Series

These three utilities give real power to your CoCo 3.

Ramdisk Lightning

This is the best Ramdisk available. It lets you have up to 4 mechanical disk drives and 2 Ram drives on-line and is fully compatible with our printer spooler below.

Printer Lightning

Load it and forget it--except for the versatility it gives you. Never wait for your printer again! Printer runs at high speed while you continue to work at the keyboard!

Backup Lightning

This utility requires 512K. Reads your master disk once and then

makes superfast multiple disk backups on all your drives! No need to format blank disks first! Supports 35, 40 or 80 track drives.

Prices

CoCo 3 only

Ram Disk Lightning, Disk.....\$19.95
Printer Lightning, Disk.....\$19.95
Backup Lightning, Disk.....\$19.95
All three, Disk.....\$49.95
Pyramix, Disk.....\$24.95

CoCo 1,2, or 3

Vocal Freedom, Disk.....\$34.95
Vocal Freedom Hackers Pac.....\$14.95

CoCo 2 or 3 only

Mental Freedom, Disk.....\$24.95
Basic Freedom, Disk.....\$24.95

CoCo 1 or 2 only

VDOS, The Undisk, ramdisk for the CoCo 1 or 2 only, Tape.....\$24.95
VDUMP, backup Undisk files to single tape file, Tape.....\$14.95
VPRINT, Print Undisk directory, Tape.....\$9.95

Everyone

Add \$2.50 shipping/handling in USA or CANADA

Add \$5.00 to ship to other countries

Dr. Preble's Programs

6540 Outer Loop

Louisville, KY 40228

24 Hour Hot Line

(502) 969-1818

Visa, MC, COD, Check

